



CF-UltraMaXX V

Ultrasonic compact thermal energy meter qp0,6, qp1,5 and 2,5

The new ultrasonic compact thermal energy meter “CF-UltraMaXX V” is the result of the consequent evolution of the successful Itron CF-Family series of static flow and thermal energy meters. CF-UltraMaXX can be used for the measurement of all relevant billing data in heating and cooling systems.

FEATURES AND BENEFITS

- » Extended dynamic range covers usual flow rate conditions in residential metering
- » Different options for implementation in communication systems
- » Versions with 2 indexes for use in combined heating and cooling applications
- » Advanced features for field data analysis.
- » Removable calculator

CE type approval certificate:
DE-10-MI004-PTB001

Communication

CF-UltraMaxx can be ordered in a various choice of integrated communication options in order to fit best to customers smart metering needs. Beside wired systems using repetition pulse output or M-Bus communication the UltraMaXX is also available for wireless systems such as Itron AnyQuest and Everblu.

Advanced memory features for field data analysis

CF-UltraMaXX can be ordered with advanced features such as tariff function and integrated data logger. Together with the dedicated UltraMaXX service software this features enables the user to get detailed information about the heating and cooling system operation over time.

Combined heating and cooling systems

Optionally UltraMaXX is available for use in combined heating & cooling applications. These versions are equipped with two independent energy registers for heating and cooling. The change from heating to cooling registering depends on real temperature conditions in the application.

Installation in all positions

The hydraulic is approved for installation in any vertical or horizontal position, even top down. This, together with the flexible calculator fixation, ensures to find a perfect reading position in any application.



Flexible calculator fixation ensures perfect reading position.

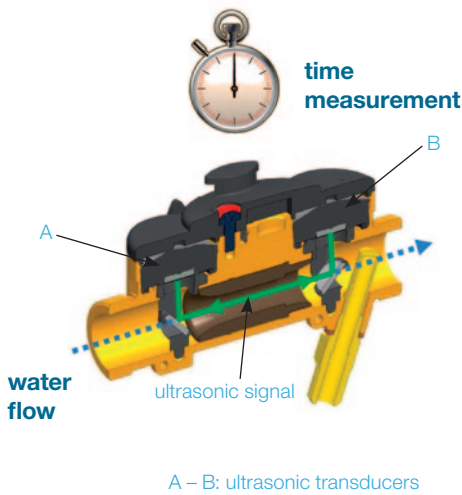

A – B: ultrasonic transducers

ULTRASONIC TECHNOLOGY IN SMALLEST DIMENSIONS

The ultrasonic technology uses the principle of time of flight difference in the measuring pipe. The ultrasonic transducers A and B operates both as receiver and transmitter for the ultrasonic signal.

The time of flight of the signal downstream is shorter than upstream. The higher the flow rate the higher the difference in propagation time.

DYNAMIC RANGE

Due to its wide dynamic range, the CF-UltraMaXX V qp1,5 can be used for all applications in residential metering which requires usually two different product versions qp0,6 or qp1,5. Both UltraMaXX V qp1,5 and 2,5 are approved for a dynamic range of 1/250 (qi/qp).

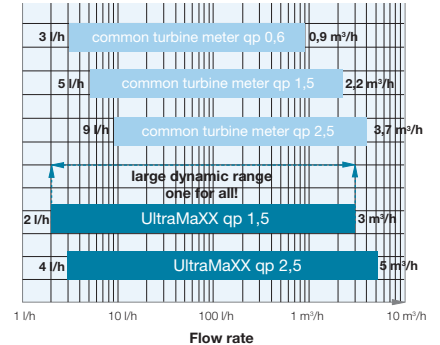

MULTIFUNCTIONAL DISPLAY

The LCD is organized in three different loops to ensure the best compromise between simplest reading for regular billing purposes and giving access to all data required for service activities.

- 2 - fixed date reading loop with monthly indexes of energy and volume of previous 18 month
- 3 - service loop with flow, power, temperatures, peak values*, alarm codes and many other service information.

- 1 - billing loop with energy indexes, volume indexes, volume indexes of external water meters*, tariff indexes*.

*optional displays

COMMUNICATION OPTIONS

CF-UltraMaXX will be delivered with integrated options. This allows quickest installation on site with minimum effort during systems set-up. Following integrated option are available in different combinations (available combinations see reference table).

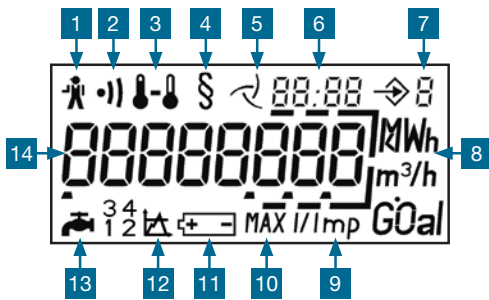

- | | |
|--|---|
| <ul style="list-style-type: none"> 1 Alarm Icon
- operation error 2 Transducer warning
- Low signal level 3 Temperatures
- permanent: Ts, Tr or dT
- blinking: error 4 Metrological indicator
- Index approved for billing 5 Flow indicator
- permanent: flow
- blinking: no flow 6 Date and Time
- fixed dates, peak, tariff 7 LCD Loop indicator | <ul style="list-style-type: none"> 8 Units
- actual physical unit 9 Pulse input value
- of external water meters 10 Peak value
- power, flow, Ts 11 Battery warning
- end of battery lifetime expected 12 Tariff index 13 External water meter
- Number of displayed counter 14 Main index 8 digits
- Digit size: 6,5mm x 3,3mm |
|--|---|

M-Bus	
Description	Bi-directional serial interface for implementation in M-Bus networks
Protocol	EN 13757-3, 300/2400Baud, variable data protocol
Data	Energy, Volume, Flow, Power, Temperatures, operation time, status, monthly indexes + additional data frames
M-Bus PS	
Description	Bi-directional serial interface for implementation in M-Bus networks. Power supply of thermal energy meter from M-Bus (2 unit loads) + 1 year back-up battery.
Protocol & Data	See M-Bus
Repetition E & V	
Description	Pulse output / repetition of Energie and Volume display
Pulse weight	LCD in kWh / MWh: 1 kWh / 10L LCD in GJ: 10MJ / 10L
Characteristic	Passive output, open collector; max. 30V / 20mA; pulse width 120ms
WM pulse input	
Description	Additional input for water meters equipped with pulse output. Visualization of WM current and monthly indexes, remote reading by optical interface or M-Bus.
Pulse weight	1L, 2,5L, 10L, 25L, 100L or 250L (user configuration), 0,25Hz max. pulse frequency
Characteristic	Active input, 3V detection voltage, On/Off resistance ≤ 500Ω / ≥ 1MΩ
RF Radio	
Description	Bi-directional serial communication interface for implementation in walk-by or fixed network radio systems
Protocol	Radian open protocol, 433 Mhz
Data	Energy, volume, flow, temperatures, status. Via transparent mode access to all M-Bus frames
Systems	Itron AnyQuest walk-by radio system; Itron Everblu fixed network radio system.

Memory option

Advanced memory	
Description	Extra large internal memory to provide peak values, tariff function + data logger
Peak values	Maximum values of flow, power and supply temperature, user programmable averaging period (1...1440 minutes); history of last 18 month maximum values
Tariff function	Energy and volume tariff indexes, user programmable threshold parameter (P, Q, Tin, Tout or time window) and threshold value (2 steps)
Data logger	4 user programmable independent data logger (working in parallel) <ul style="list-style-type: none"> > Yearly data logger (16 years, programmable day and month at midnight) > Monthly data logger (48 month , last day of the month) > Daily data logger (460 days, at midnight). > Programmable data logger (1500 steps, logging period 1 minute to 7 days) 6 variables can be selected for each logger, table of variables: Power, Flow, Supply temperature, Return temperature, Energy, Volume, WM 1...4 volume (if WM option active), tariff indexes and peak values

Technical data

Calculator		
Temperature range	°C	0-90 / 0 – 150*
Temperature difference	K	3-90 / 3 – 150*
Display resolution 8 digits	kWh	99.999,999
	MWh	99.999,999
	GJ	99.999,999
	GJ	999.999,99
	m³	999999,99
Power supply	Lithium cell 10+1 years (standard) Lithium cell 6+1 years (optional version) by M-Bus (optional version)	
Environmental classification	EN1434 – C / 2004/22/EC class E1, M1	
Ingress protection	IP	54
Environmental temperature	°C	5...55°C (operation) / -10...60°C (transport)
Optical interface	ZVEI / EN 60870-5 / M-BUS protocol	
Temperature sensors	Type	Pt500
Cable calculator <-> flow meter	L [m]	0,5m

Flow meter		qp0,6	qp1,5	qp2,5
Max. overload flow	qss [m³/h]	1,32	3,3	5,5
Maximum flow	qs [m³/h]	1,2	3	5
Nominal flow	qp [m³/h]	0,6	1,5	2,5
Minimum flow	qi [l/h]	6	6	10
Cut off flow rate	qc [l/h]	2	2	4
Accuracy class		EN1434 – cl. 2	EN1434 – cl. 2	EN1434 – cl. 2
Dynamic qp/qi		100	250	250
Nominal pressure	PN [bar]	16	16	16
Head loss @ qp	bar	0,04	0,21	0,22
Temperature range permanent / short	°C	1...120 / 130	1...120 / 130	1...120 / 130
Ingress protection	IP	67	67	67
Available sizes	¾"-110	X	X	-
	1"-130	X	X	X

Temp.-Sensor		
Type	PT500	
Pocket Sensors (standard)	Type	PS 50mm / Ø6mm / spiral cable
Temperature range	°C	0...90
Cable length	m	1,2
Pocket Sensors (optional)	Type	PS 50mm / Ø6mm / silicone cable
Temperature range	°C	0...150
Cable length	m	1,75 / 5 / 10
Direct Sensors (optional)	Type	DS 27,5mm / EN1434 / pur cable
Temperature range	°C	0...105
Cable length	m	1,5
Direct Sensors (optional)	Type	DS 27,5mm / EN1434 AGFW / silicone cable
Temperature range	°C	0...150
Cable length	m	1,75 / 5 / 10

* indication on type plate depends on type of connected temperature sensors.

Unit Dimensions

	¾" - 110mm	1" - 130mm
A	110	130
B	G¾ A	G1 A
C	102	102
D	86	86
E	128	128
F	88	88
G	86	86
H	126 (optional)	126 (optional)

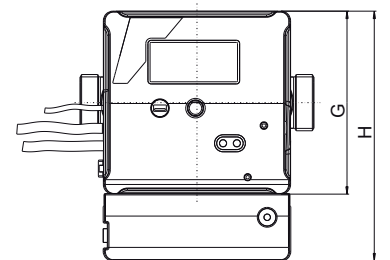
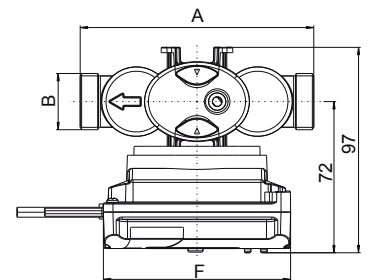
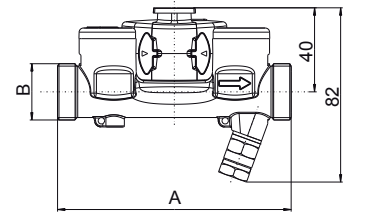
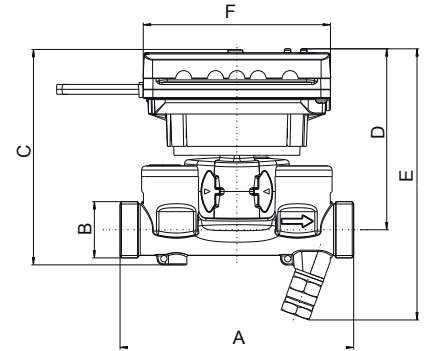

HEAD LOSS

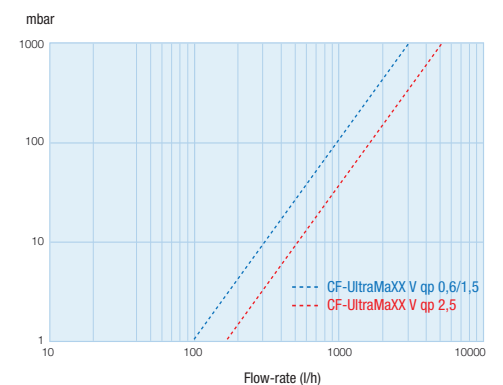

REFERENCES – PRODUCT VERSIONS

CF-UltraMaXX V equipped with T-Sensors, k-correction cold pipe, LCD in kWh, Li-Battery 10+1 years lifetime (except UltraMaXX M-Bus PS + 2 WM which is powered by M-Bus 2 ULs), English labels & manuals.



Product versions Pocket Short 1,2m (PS6)	Memory	Calculator size	References***	
		S	qp1,5 - ¾" - 110mm	qp2,5 - 1" - 130mm
UltraMaXX V	Standard	S	5614 23 0600 37	5618 23 0600 37
UltraMaXX V Advanced	Advanced	S	5614 23 0900 37	5618 23 0900 37
UltraMaXX V M-Bus	Standard	S*	5614 23 1600 37	5618 23 1600 37
UltraMaXX V M-Bus Advanced	Advanced	S*	5614 23 1900 37	5618 23 1900 37
UltraMaXX V M-Bus + 4WM	Advanced	L**	5614 23 2900 37	5618 23 2900 37
UltraMaXX V M-Bus PS + 2WM	Advanced	L**	5614 23 5300 37	5618 23 5300 37
UltraMaXX V Repetition E & V	Advanced	S*	5614 23 4900 37	5618 23 4900 37
UltraMaXX V RF Radio	Advanced	L	5614 23 6900 37	5618 23 6900 37



Product versions Direct Short 1,75m (DS EN1434)	Memory	Calculator size	References***	
		S	qp1,5 - ¾" - 110mm	qp2,5 - 1" - 130mm
UltraMaXX V	Standard	S	5614 73 0604 37	5618 73 0604 37
UltraMaXX V Advanced	Advanced	S	5614 73 0904 37	5618 73 0904 37
UltraMaXX V M-Bus	Standard	S*	5614 73 1604 37	5618 73 1604 37
UltraMaXX V M-Bus Advanced	Advanced	S*	5614 73 1904 37	5618 73 1904 37
UltraMaXX V M-Bus + 4WM	Advanced	L**	5614 73 2904 37	5618 73 2904 37
UltraMaXX V M-Bus PS + 2WM	Advanced	L**	5614 73 5304 37	5618 73 5304 37
UltraMaXX V Repetition E & V	Advanced	S*	5614 73 4904 37	5618 73 4904 37
UltraMaXX V RF Radio	Advanced	L	5614 73 6904 37	5618 73 6904 37

*product delivered with cable 1m length for connection to AMR system (M-Bus: 2 wires, Rep E&V: 4 wires)

**product equipped with cable clamps for connection to AMR system

***standard portfolio, other versions on request (e.g. qp0,6, T-sensors 150°C, LCD MWh/ GJ, 6+1 year bat., combined heating & cooling)



Small size calculator (S)
cable output in case of wired options



Large size calculator (L)
Covered cable clamps in case of wired options

REFERENCES - ACCESSORIES

Installation kits for DN15 or 20 pipe systems including waiting pipe, couplings, valves to close the pipe during meter exchange and T-piece (pocket type)* including or DS-valve (direct type)*.

Items	Description	References*
EBS DN15-G-KH	Installation Kit ¾"-110 pocket, incl. valves and T-piece	2433000006
EBS DN20-G-KH	Installation Kit 1"-130 pocket, incl. valves and T-piece	2423000006
EBS DN15-D-KH	Installation Kit ¾"-110 DS, incl. valves for return and supply pipe	2433000106
EBS DN20-D-KH	Installation Kit 1"-130 DS, incl. valves for return and supply pipe	2431000106

* one temperature sensor is direct installed in the meter body, usually in return pipe. The second temperature sensor, usually in supply pipe, should be installed in a T-piece (for pocket type) or in a special DS-valve (in case of direct immersion sensors).

Our company is the world's leading provider of smart metering, data collection and utility software systems, with over 8,000 utilities worldwide relying on our technology to optimize the delivery and use of energy and water.

To realize your smarter energy and water future, start here: www.itron.com/de

For more information, contact your local sales representative or agency:

ITRON HEAT METERING

Allmess GmbH
Am Voßberg 11
23758 Oldenburg i.H.
Deutschland

Phone: 0 43 61/62 5-0
Fax: 0 43 61/62 5 -250