

DIRIS A60

Operating instructions

F GB D I NL E P



Contents

DANGER AND WARNING _____	3
PRELIMINARY OPERATIONS _____	4
PRESENTATION _____	5
INSTALLATION _____	6
PROGRAMMING _____	12
OPERATION _____	43
CONNECTION TEST FUNCTION _____	48
ASSISTANCE _____	52
TECHNICAL CHARACTERISTICS _____	53
GLOSSARY OF ABBREVIATIONS _____	56

DANGER AND WARNING

This equipment must be mounted only by professionals.

The manufacturer shall not be held responsible for failure to comply with the instructions in this manual.

Risk of electrocution, burns or explosion

- the device must be installed and serviced only by qualified personnel
- prior to any work on or in the device, isolate the voltage inputs and auxiliary power supplies and short-circuit the secondary winding of all current transformers (PTI SOCOMEC)
- always use an appropriate voltage detection device to confirm the absence of voltage
- put all mechanisms, door and covers back in place before energising the device
- always supply the device with the correct rated voltage

Failure to take these precautions could cause serious injuries.

Risk of damaging device

Check the following :

- the voltage of the auxiliary power
- the frequency of the distribution system (50 or 60 Hz)
- the maximum voltage across the voltage-input terminals, (V1, V2, V3 and VN) 500 V AC phase-to-phase or 289 V AC phase-to-neutral
- a maximum current of 6 A on the current-input terminals (I1, I2 and I3)

DANGER AND WARNING

For personnel and product safety please read the contents of these operating instructions carefully before connecting.

Check the following points as soon as you receive the package:

- the packing is in good condition,
- the product has not been damaged during transit,
- the product reference number conforms to your order,
- the packaging included a product fitted with detachable terminal strips,
- operating instructions.

PRÉSENTATION

1. Key-pad with 6 dual-function keys (display or programming)
2. Backlit LCD display
3. Phase
4. Values
5. Unit
6. Activity indicator on the communication bus
7. Energy metering indication
8. Hour meter and energy display
9. Alarm relay 1
10. Alarm relay 2



INSTALLATION

RECOMMENDATIONS

- avoid being close to systems generating electromagnetic disturbances,
- avoid vibrations involving accelerations greater than 1 G for frequencies lesser than 100 Hz.

CUT-OUT DIAGRAM, MOUNTING

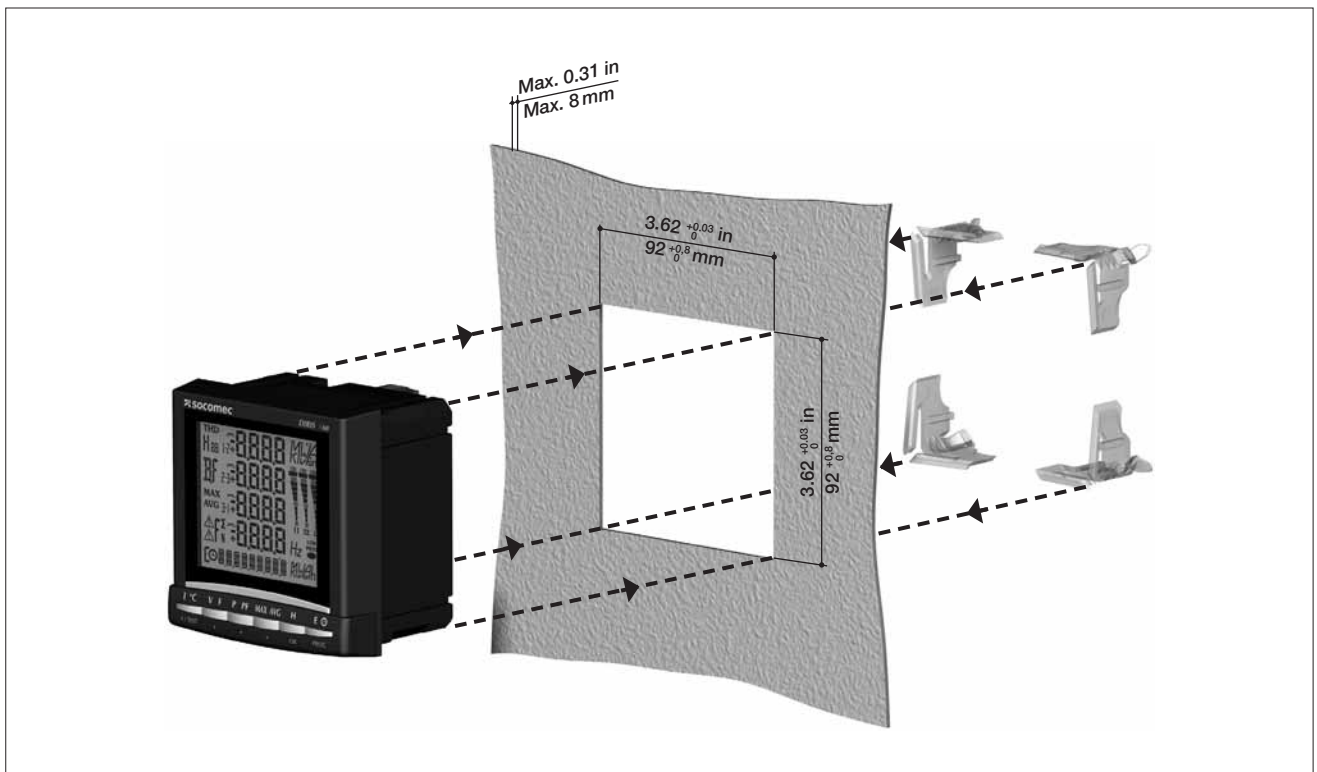
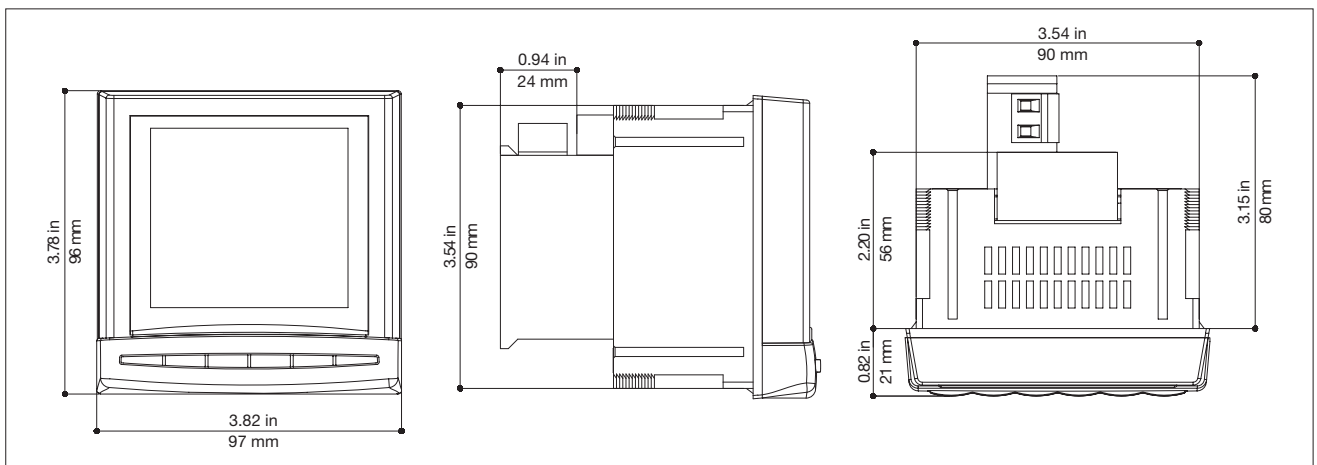

CONNECTION

Each CT's secondary winding must be short-circuited when disconnecting the DIRIS. This can be done automatically using one of Socomec's catalogue products: the PTI. Please contact us for further information.

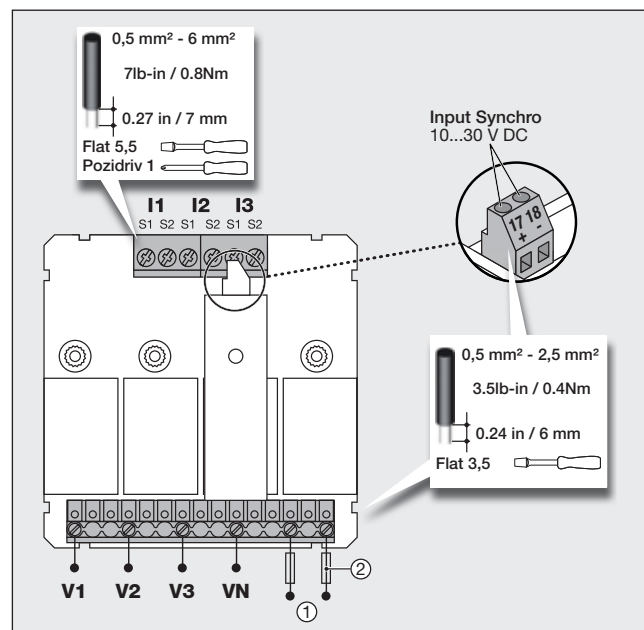
**DIRIS A60**

- ① *Aux.:* IEC / CE 110 ... 400 V AC
120 ... 350 V DC
12 ... 48 V DC
- ② *Fus.:* 0.5 A gG / BS 88 2A gG / 0.5 A class CC

INSTALLATION

MODULES OPTION

DIRIS A60 can be fitted with optional modules:

- **JBUS/MODBUS communication;**
ref: 4825 0092:
RS485 JBUS/MODBUS serial port in RTU mode with a speed from 2400 to 38400 baud. (Operating instructions ref: 536 103).
- **PROFIBUS-DP Communication;**
ref: 4825 0205:
RS485 PROFIBUS-DP serial port with a speed from 9,600 baud to 12 Mbaud. (Operating instructions ref: 535 749).
- **Pulse outputs; ref: 4825 0090:**
2 pulse outputs connected to the metering of energy in kWh, kvarh and KVAh. (Operating instructions ref: 536 045).
- **Analogue outputs; ref: 4825 0093:**
2 analogue outputs 4/20 mA or 0/20 mA configurable for measures performed by the DIRIS A60. 2 modules can be installed, a maximum of 4 outputs. (Operating instructions ref: 536 048).
- **Inputs/Outputs; ref: 4825 0094:**
2 outputs allocated for alarms, for voltage, current, power, power factor and THD, or remote control.
2 inputs for the metering of pulses or controlling position. (Operating instructions ref: 536 047).
- **Ethernet; réf : 4825 0203 :**
Link with RJ45 connector.
Protocol MODBUS/TCP or JBUS/MODBUS RTU with TCP. WEB-server for configuration of the product, display of the main quantities and diagnosis. (Operating instructions ref.: 535 748).
- **Ethernet/gateway RS485; ref: 4825 0204:**
Link with RJ 45 connector.
Master gateway function MODBUS with 3 points link RS485.
Protocol MODBUS/TCP or JBUS/MODBUS RTU with TCP. WEB-server for the configuration of the product, display of the main quantities and diagnosis. (Operating instructions ref.: 535 748).
- **Temperature; ref: 4825 0206.**
PT100 Technology:
4 temperature indicators :
 - 1 internal
 - 3 external (PT100 input)(Operating instructions ref.: 535 750).
- **Operating earth; ref.: 48250087**
(Operating instructions ref.: 536 423).

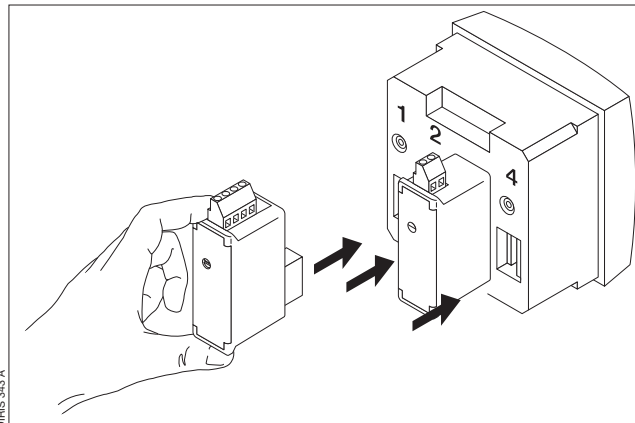

UNBALANCED THREE-PHASE NETWORK
(4NBL)

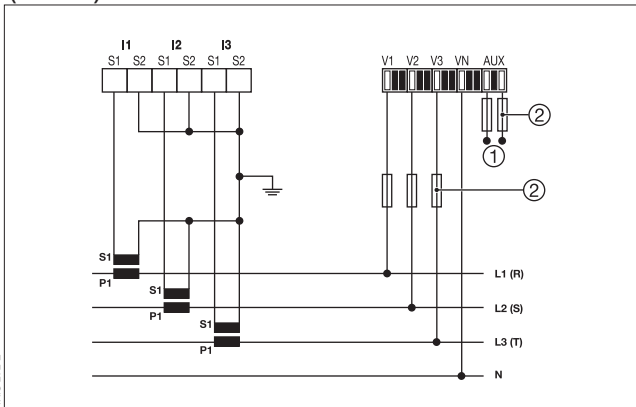

DIRIS 272 E

- ① **Aux.:** IEC / CE 110 ... 400 V AC
120 ... 350 V DC
12 ... 48 V DC
- ② **Fus.:** 0.5 A gG / BS 88 2A gG / 0.5 A class CC

UNBALANCED THREE-PHASE NETWORK
(3NBL)

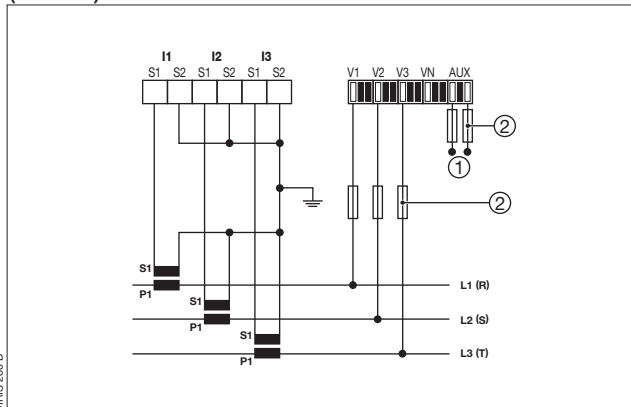

DIRIS 284 D

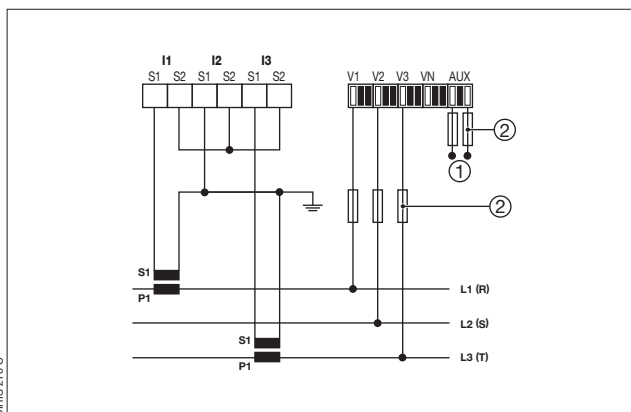

DIRIS 276 C

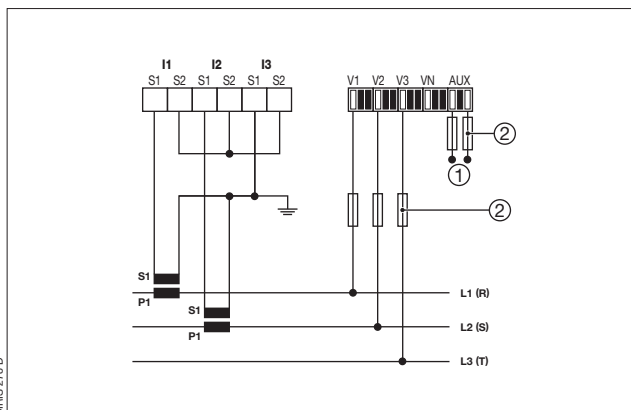

DIRIS 278 D

- ① **Aux.:** IEC / CE 110 ... 400 V AC
120 ... 350 V DC
12 ... 48 V DC
- ② **Fus.:** 0.5 A gG / BS 88 2A gG / 0.5 A class CC

TWO-PHASE NETWORK (2BL)

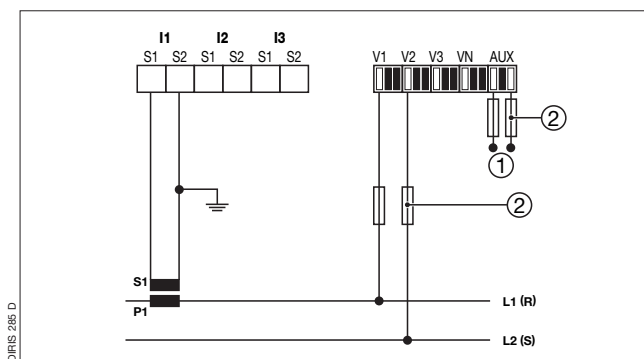

- ① **Aux.:** IEC / CE 110 ... 400 V AC
120 ... 350 V DC
12 ... 48 V DC
- ② **Fus.:** 0.5 A gG / BS 88 2A gG / 0.5 A class CC

SINGLE-PHASE NETWORK (1BL)

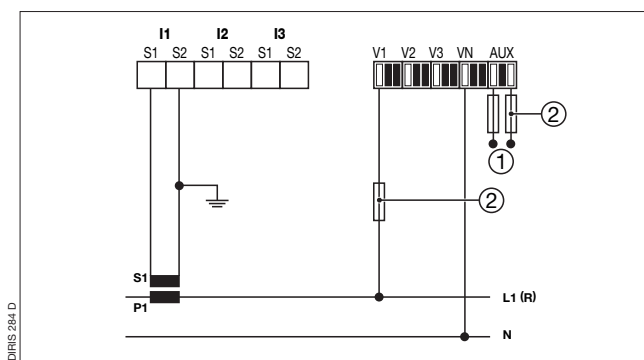

- ① **Aux.:** IEC / CE 110 ... 400 V AC
120 ... 350 V DC
12 ... 48 V DC
- ② **Fus.:** 0.5 A gG / BS 88 2A gG / 0.5 A class CC

VOLTAGE TRANSFORMER

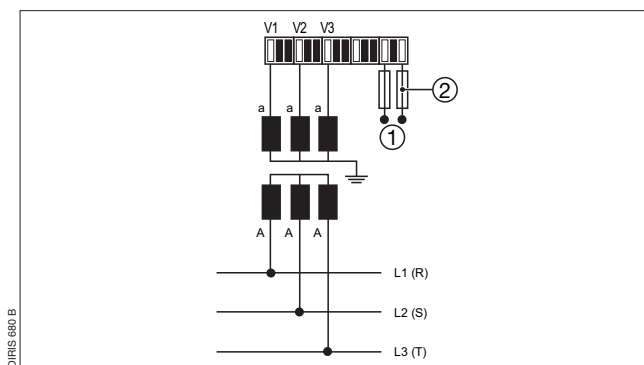

- ① **Aux.:** IEC / CE 110 ... 400 V AC
120 ... 350 V DC
12 ... 48 V DC
- ② **Fus.:** 0.5 A gG / BS 88 2A gG / 0.5 A class CC

DIRIS A60

PROGRAMMING

ACCES TO PROGRAMMING MODE (COdE 100)

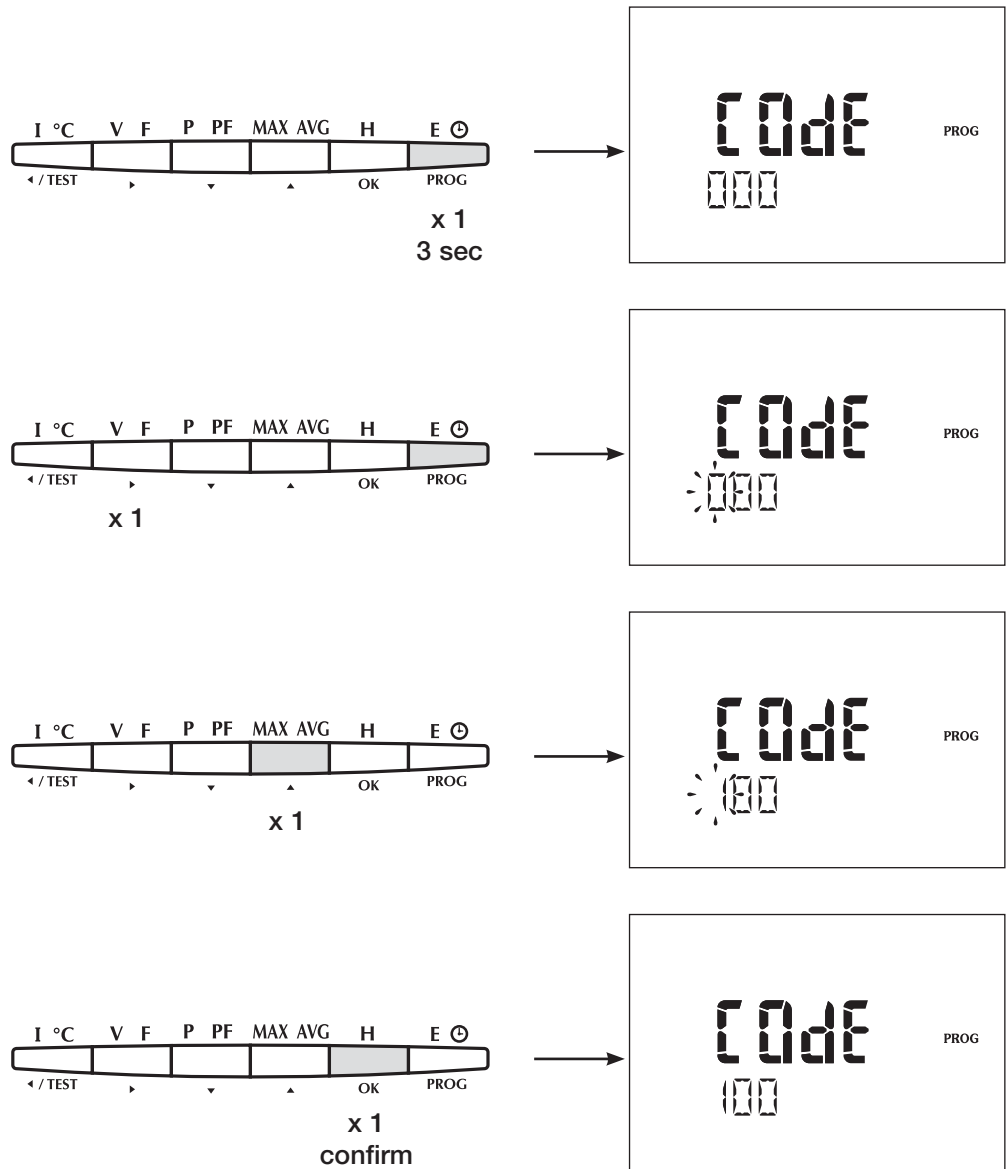

NETWORK (Example : NET = 3NBL)

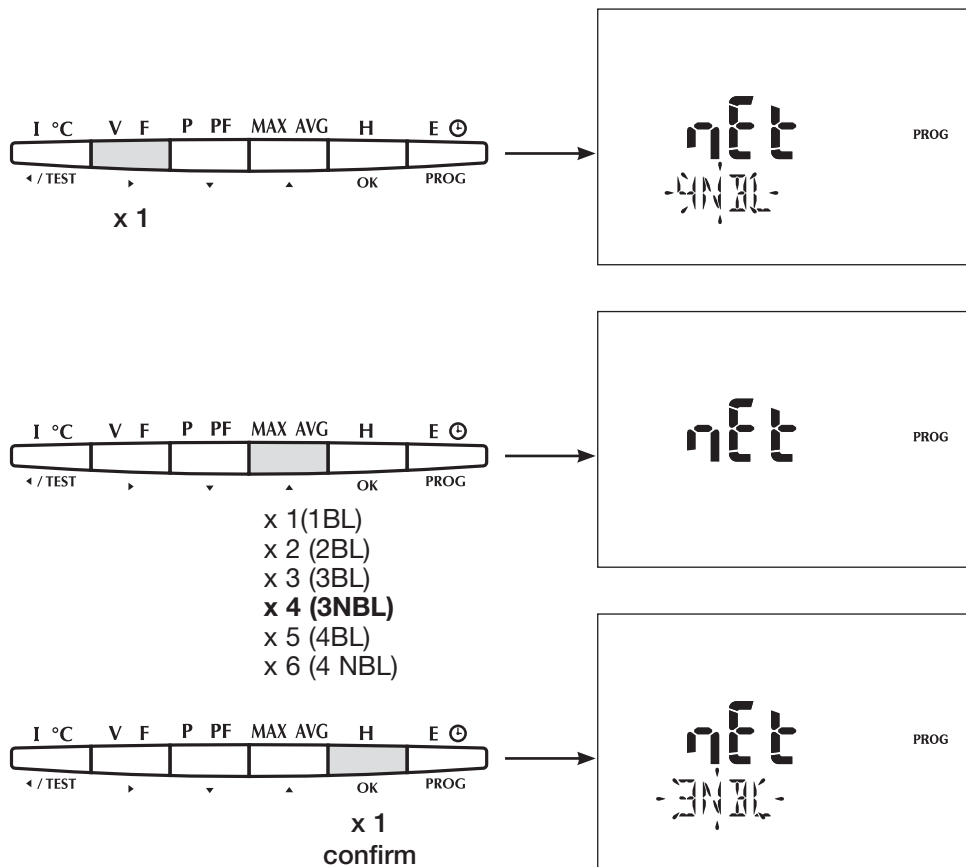

NOMINAL VOLTAGE OF THE NETWORK (phase/phase) (Example: 4NBL: U=390V)

This value is used for calculating the sliding reference voltage (Ureg) for the detection of the voltage dips and interruption, as well as voltage swell.

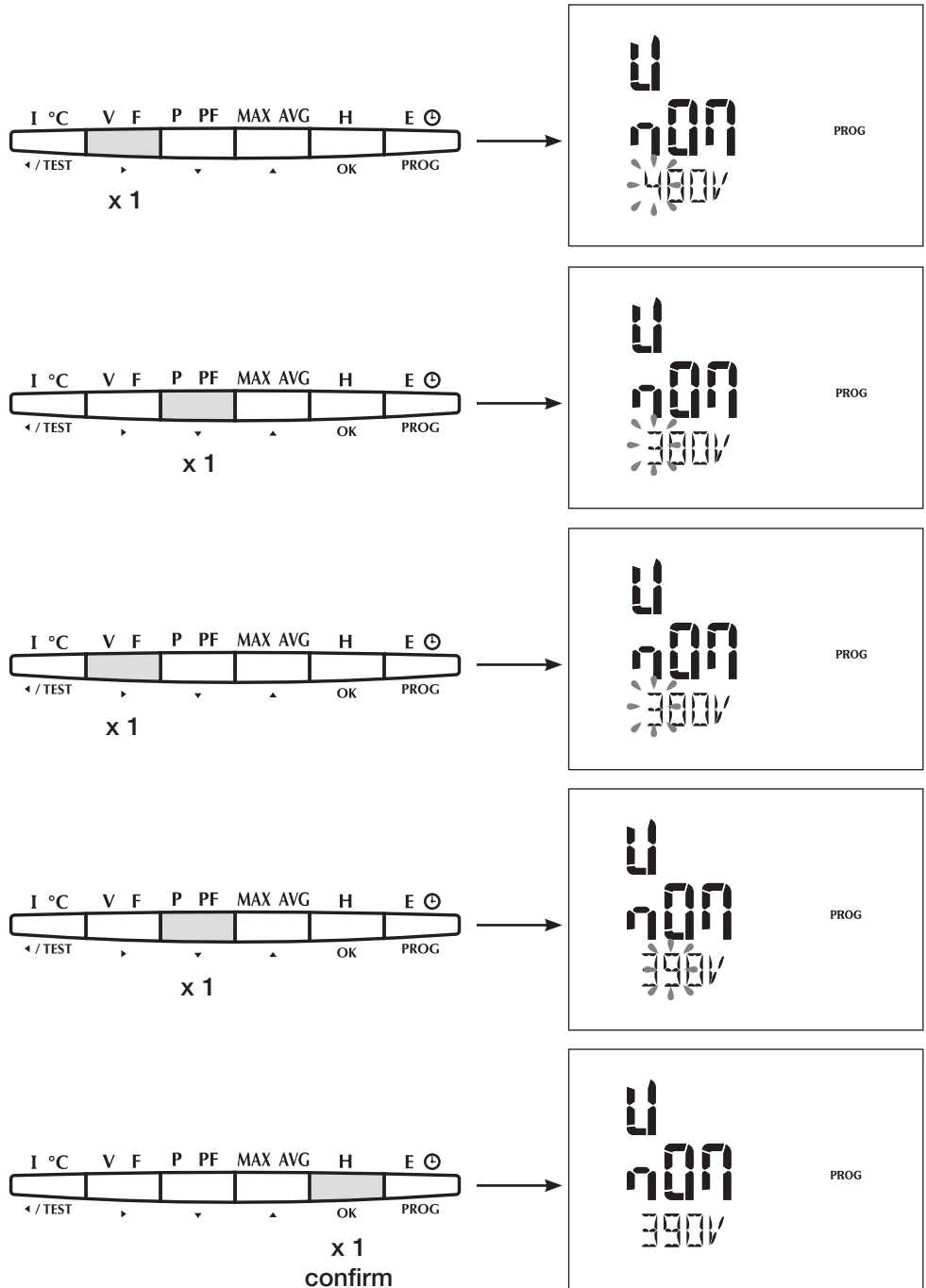

CURRENT TRANSFORMERS (Example : CT = 1500 / 5A).

Maxi 10000/5 ou 10000/1

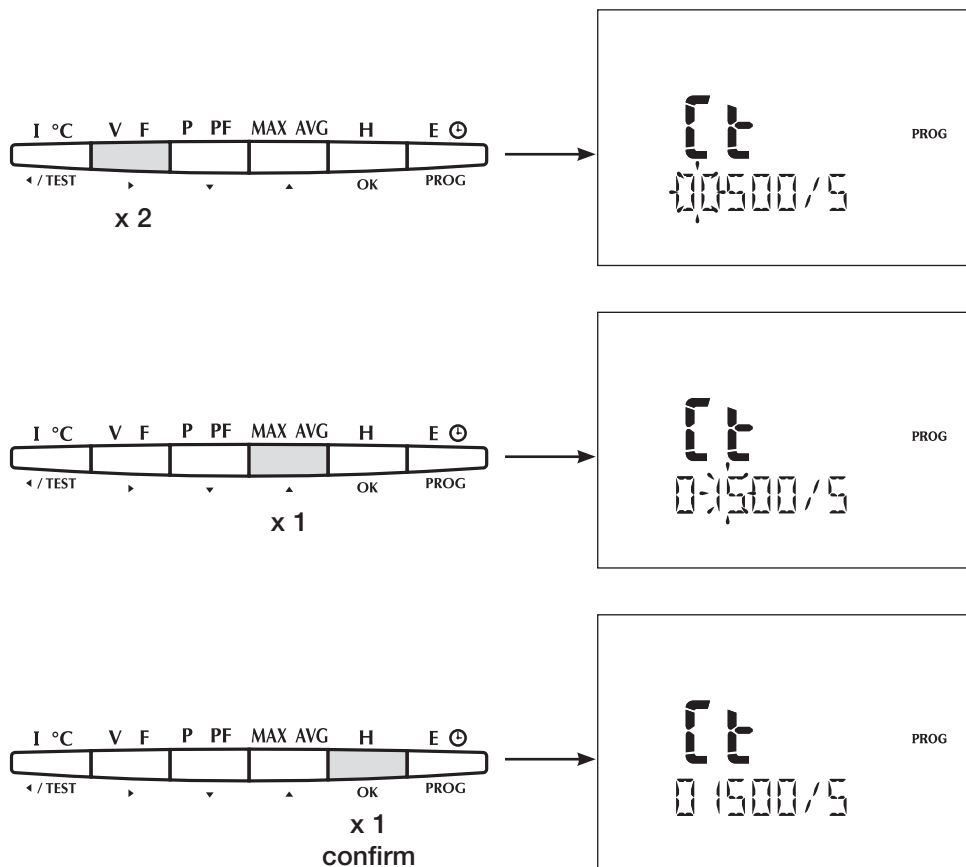

DIRIS A60

PROGRAMMING

VOLTAGE TRANSFORMER (Example : Vt = YES)

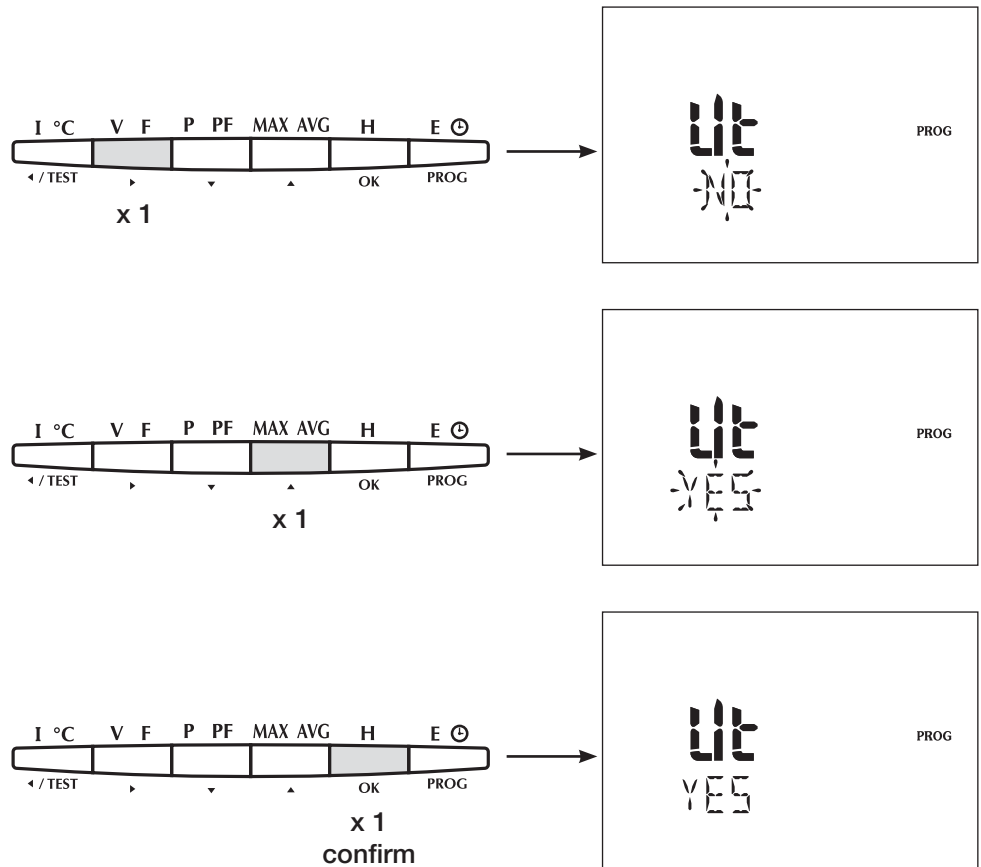

VOLTAGE TRANSFORMER PRIMARY (Example : PR = 20 000 V)

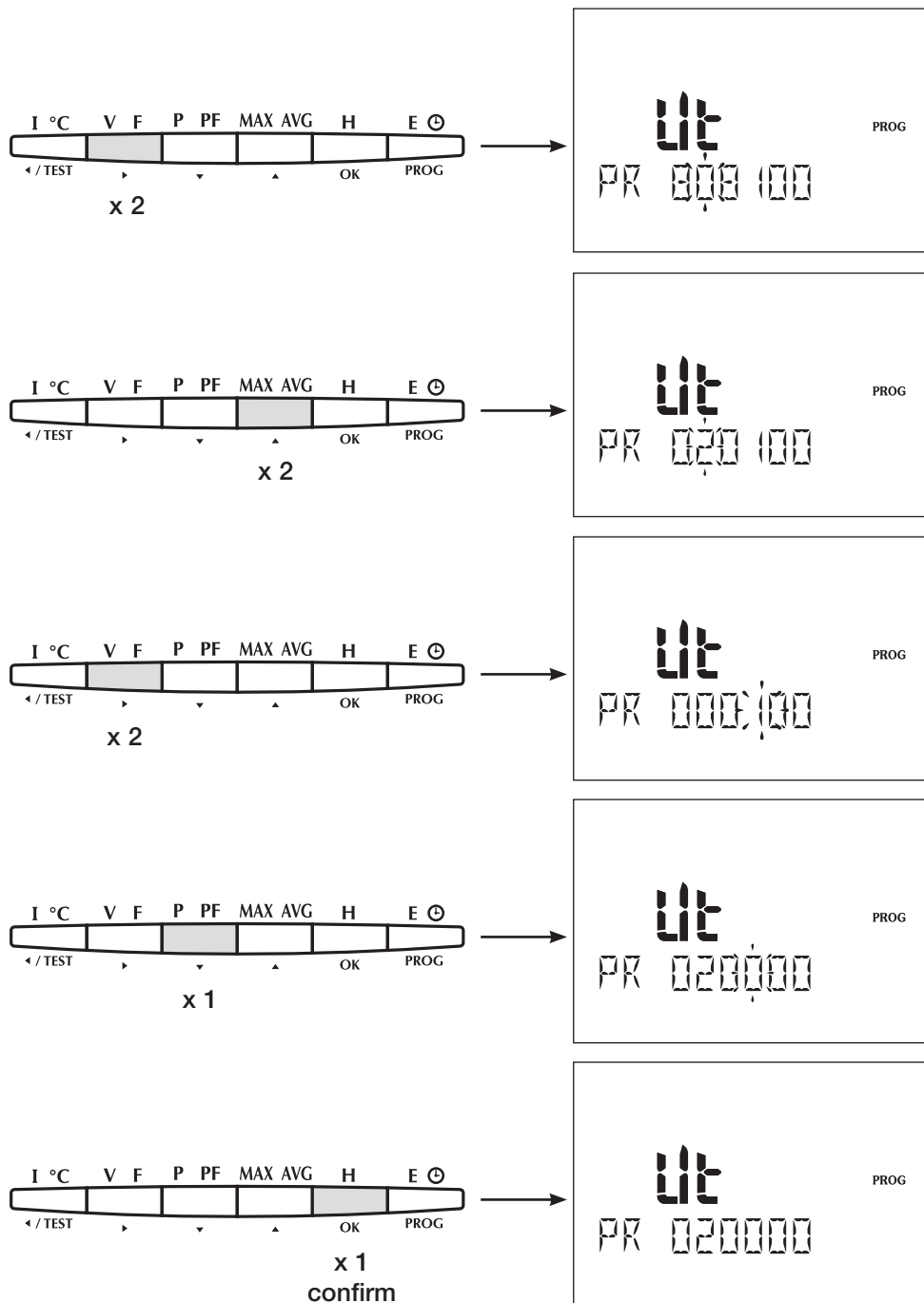

DIRIS A60

PROGRAMMING

VOLTAGE TRANSFORMER SECONDARY (Example : SE = 110 V)

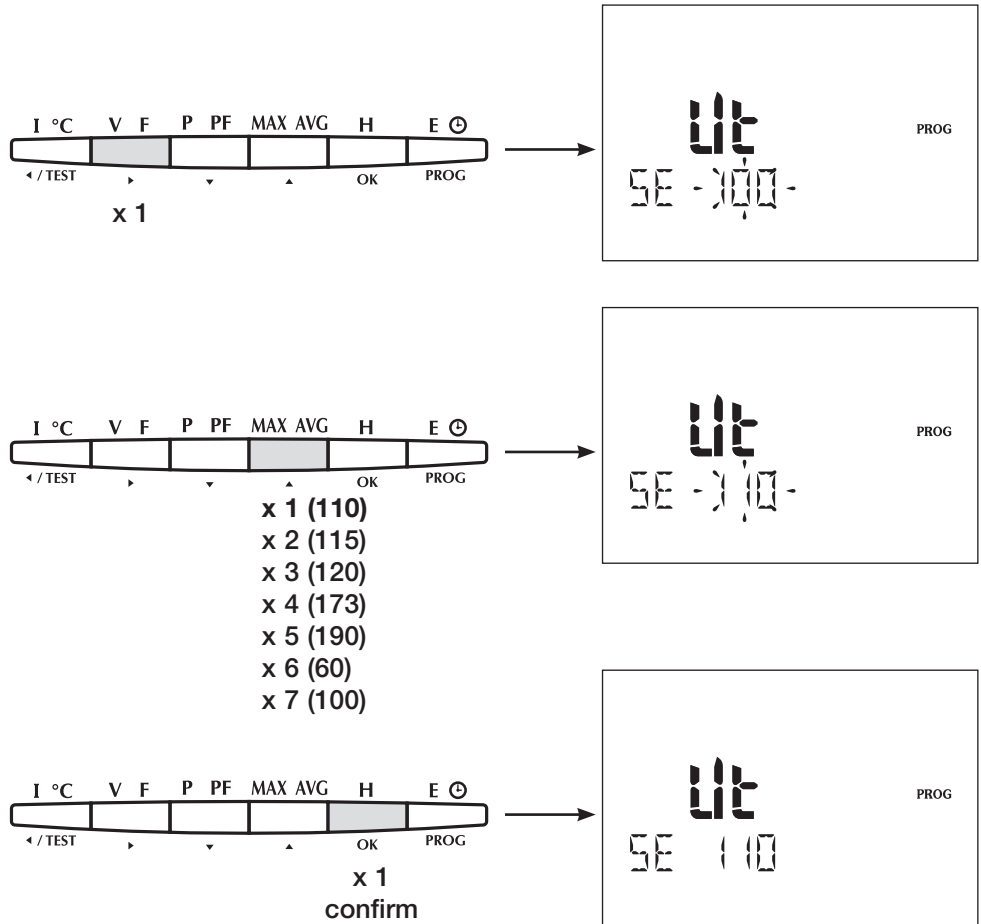

INTEGRATION PERIOD OF AVERAGE AND MAXIMUM CURRENTS

(Example : tIME 4I = 20 min)

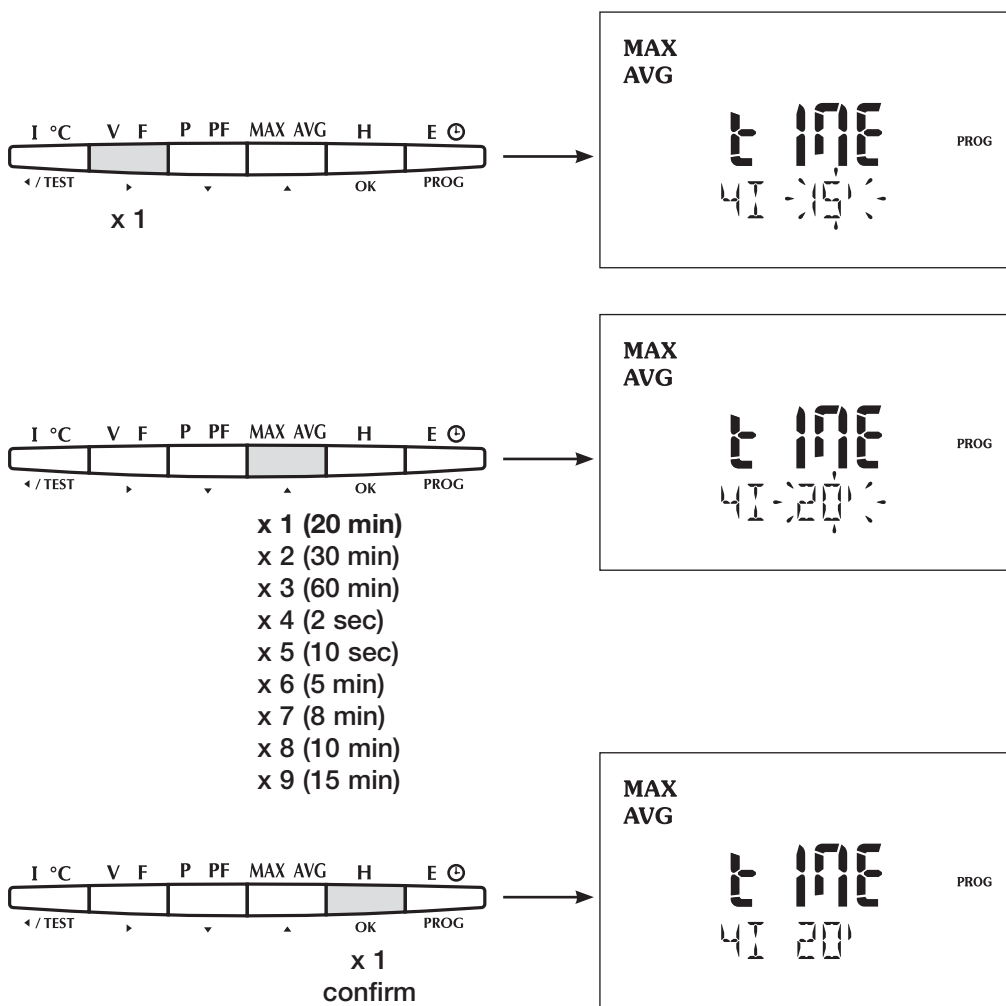

INTEGRATION PERIOD OF AVERAGE AND MAXIMUM VOLTAGES

(Example : tIME U/V = 20 min)

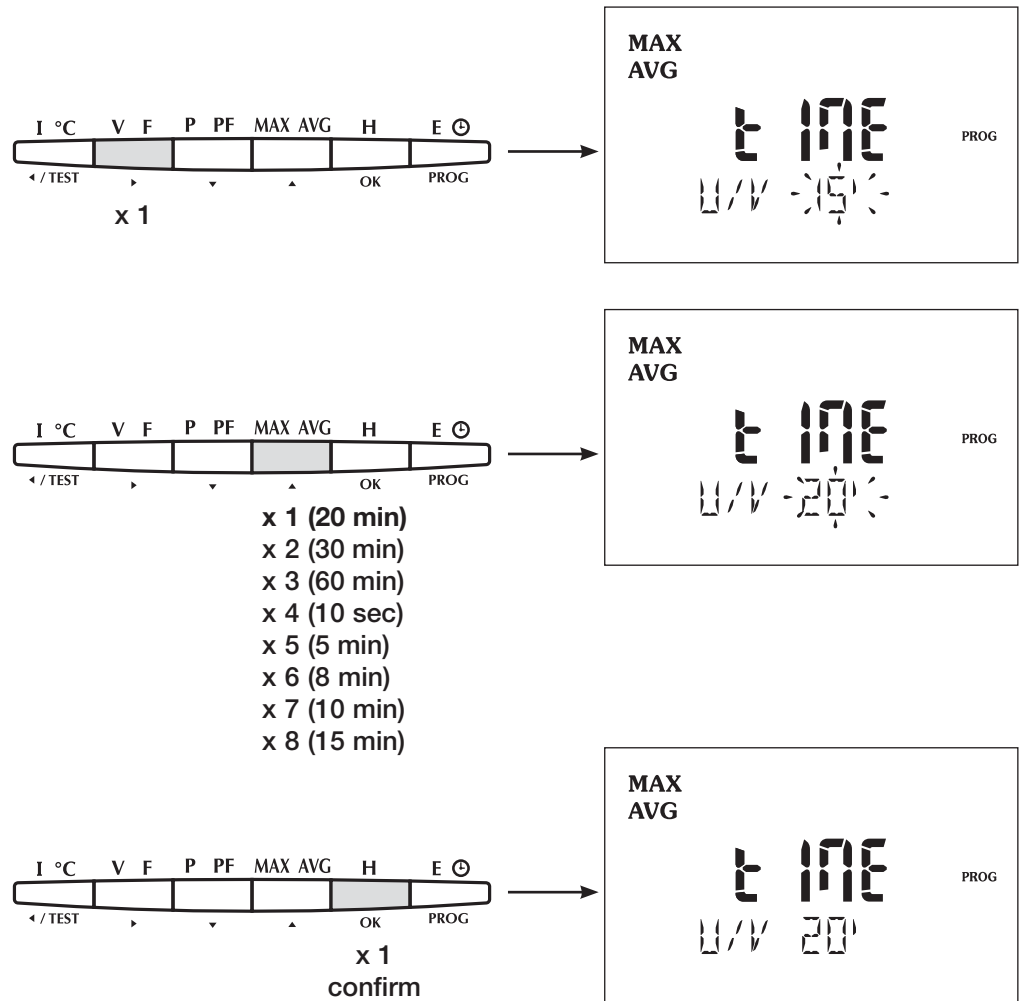

INTEGRATION PERIOD OF AVERAGE AND MAXIMUM FREQUENCIES

(Example : tIME F = 20 min)

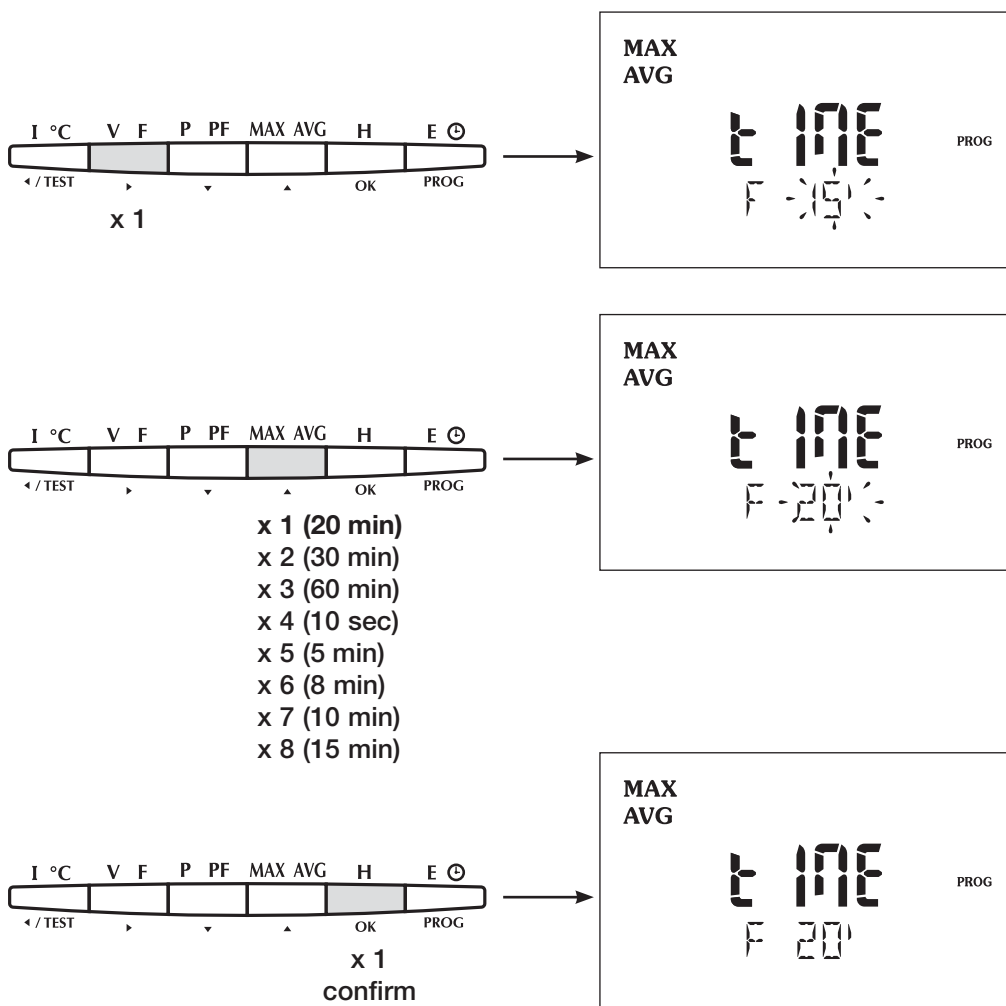

INTEGRATION OF POWER (Example : tIME P/Q/S = 20 min)

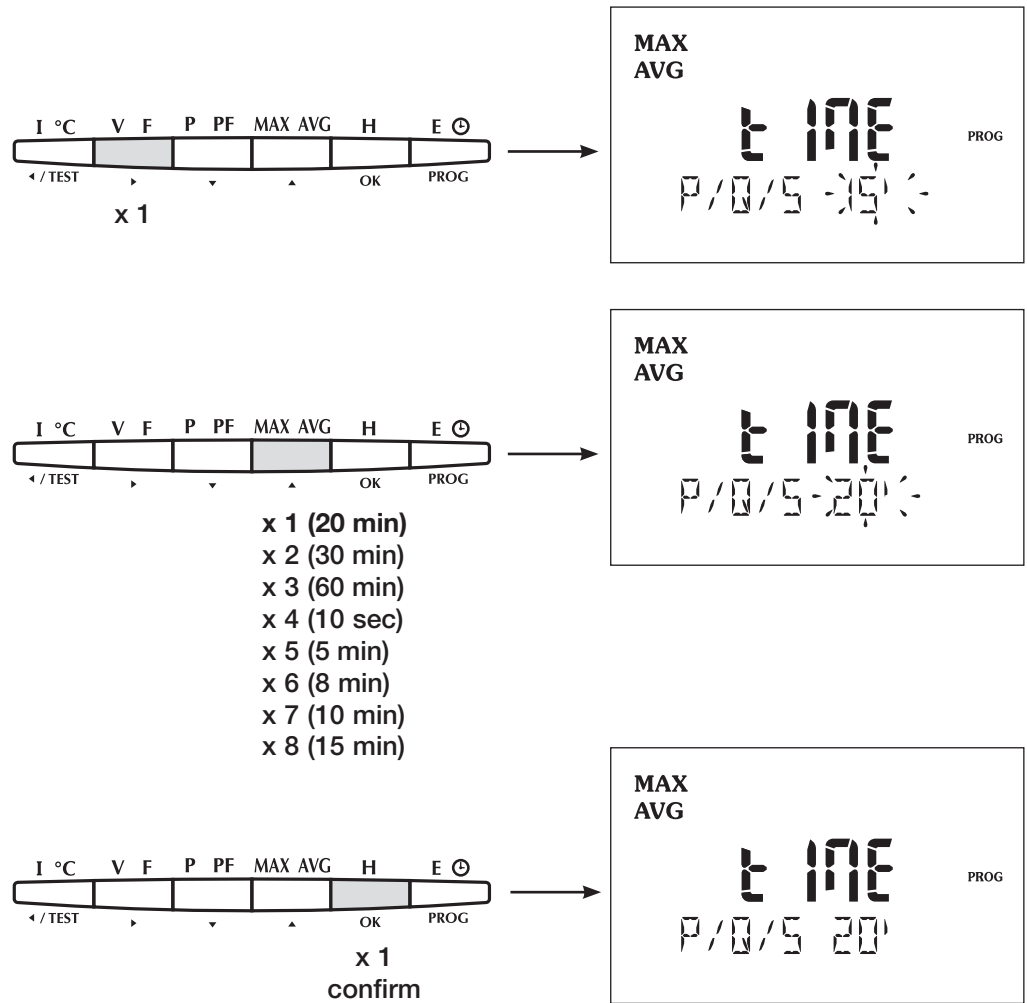

RESET OF THE MEMORIZED VALUES (Example : rSET = Ea)

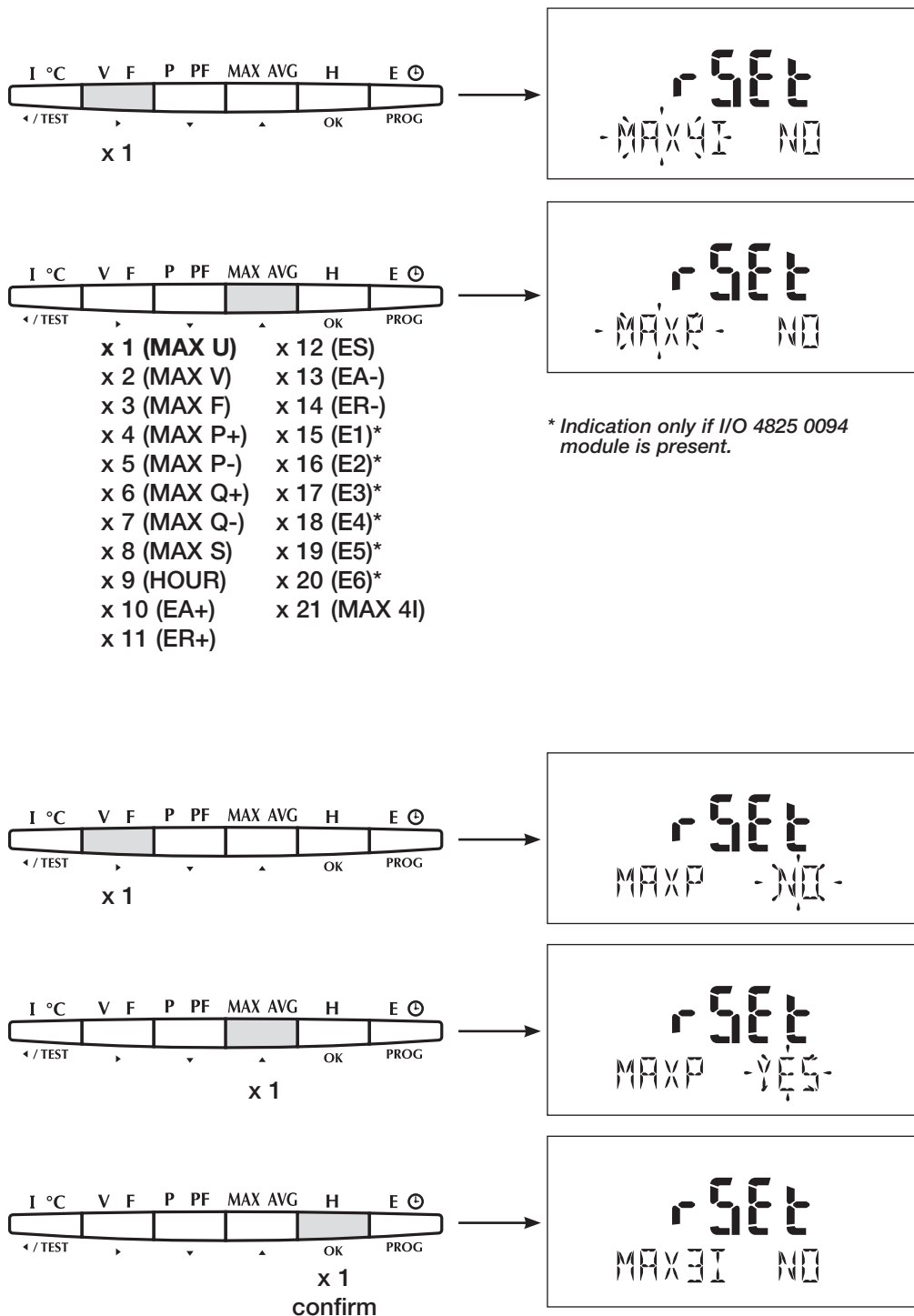

MODE OF OPERATION OF HOUR METER

(Example : hour meter (for current) with start-up at 1000A)

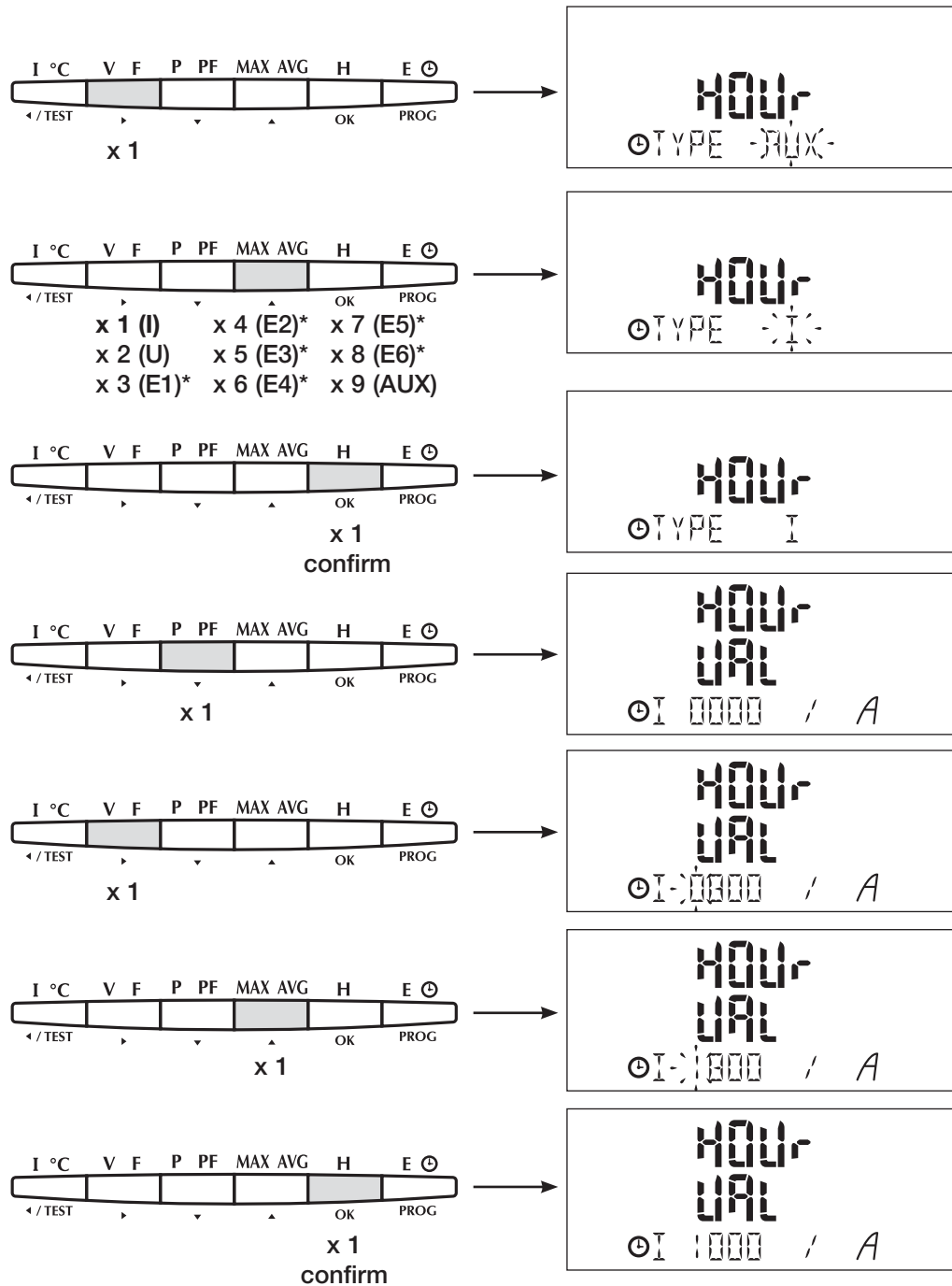

* Indication only if I/O 4825 0094 module is present.

INTERNAL OR EXTERNAL SYNCHRONIZING PULSE (Example : MEMO TOP = EXT)

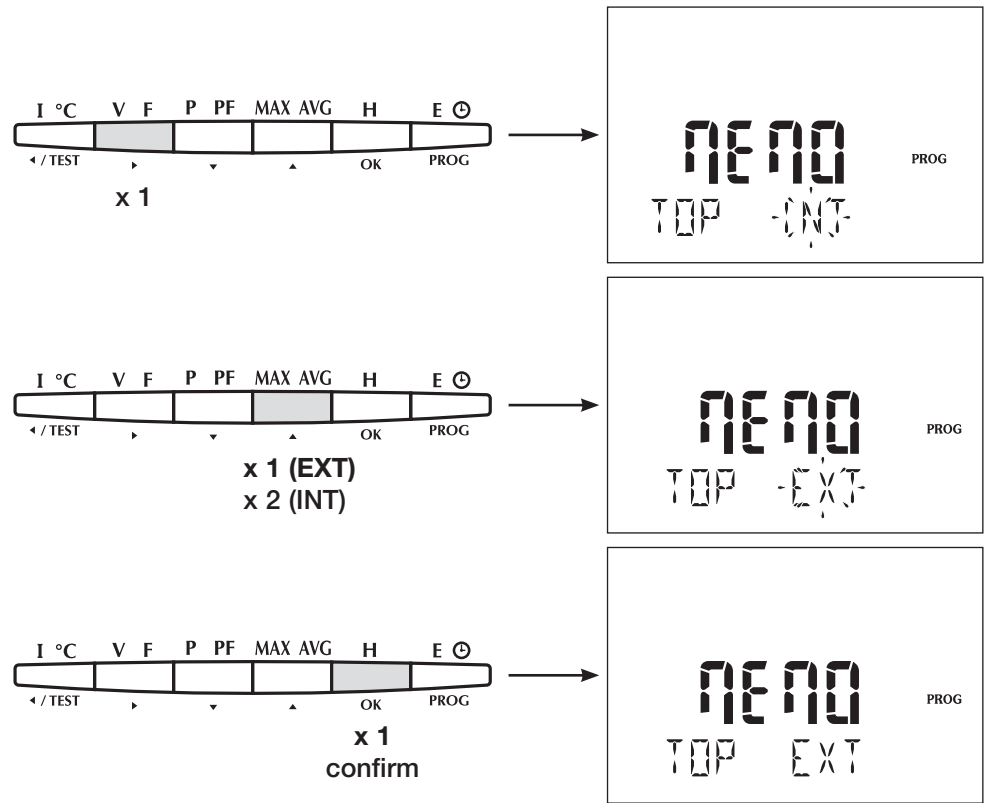

Remark:

This function is used for synchronizing the period of the Power load curves on:

INTERNAL PULSE = synchronisation en fonction de l'horloge interne du DIRIS.

EXTERNAL PULSE = synchronization as per the pulse received by the synchronization input of the module.

INTEGRATION PERIOD OF THE SYNCHRONIZING PULSE (Example : MEMO TIME = 10')

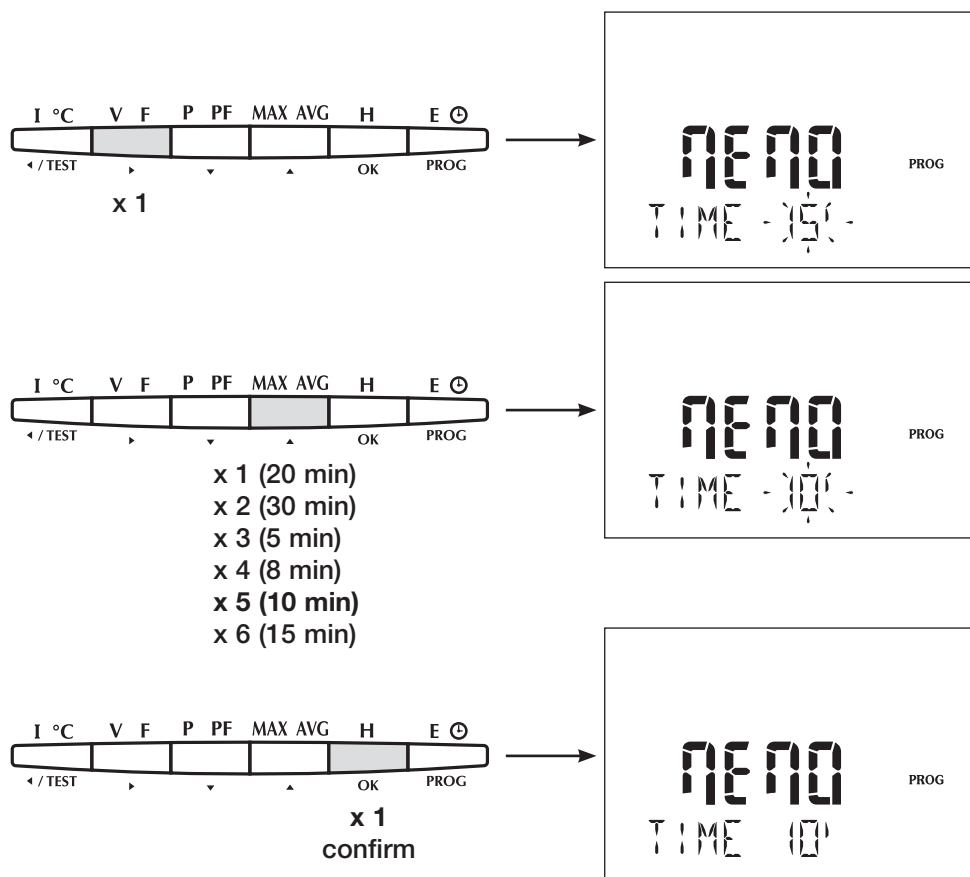

DEFINITION OF THE FUNCTIONS OF VOLTAGE DIPS AND INTERRUPTION, AS WELL AS VOLTAGE SWELL AND OVER-CURRENTS

DIRIS A60 allows detecting events such as:

- Voltage dips
- Voltage swells
- Interruption
- Over-currents

A packet of 10 RMS $\frac{1}{2}$ period curves (I1, I2, I3, V1, V2, V3, U12, U23, U31) is associated with each event detected.

An RMS $\frac{1}{2}$ curve period is made up of 120 points. For a signal at 50 Hz it represents a history on 1.2s (60 Hz for 1s). A configurable trigger (Pre-post mode from 0 to 100 %) allows distributing the number of points around the event (50% / 50% = 60 points before the event and 60 points after).

For voltage dips, swells and over-currents, an event starts if one of the quantities exceeds the determined threshold. It ends if all the quantities have come back to normal condition. (hysteresis).

For voltage interruption, an event starts if all the quantities exceed the determined threshold. It ends if one of the quantities has come back to normal condition.

Depending upon the length, the events are recorded in the following manner:

- Event < 1.2s (50 Hz), 1 packet of 10 curves over 1.2s.
- 1,2s > Event < 2.4s (50 Hz), 2 packets following 10 curves, i.e. 2.4s.
- Event > 2.4s (50 Hz), 1 packet of 10 curves consisting of the beginning of the event, 1 packet of 10 curves consisting of the end of the event.

Between these two, the values are not available.

> Voltage dips and swells

They are memorized as per IEC 61000-4-30 and EN50160 with a category B measurement method.

> Voltage interruption

It is possible to configure the outage threshold (in % of U_n), on the other hand the measurement limit of DIRIS A60 which is 29 V AC neutral phase and 50 V AC phase/phase must be taken into account.

> Over-currents

The detection threshold is configured in % of the CT rating. Detection is made as in the case of voltage swell.

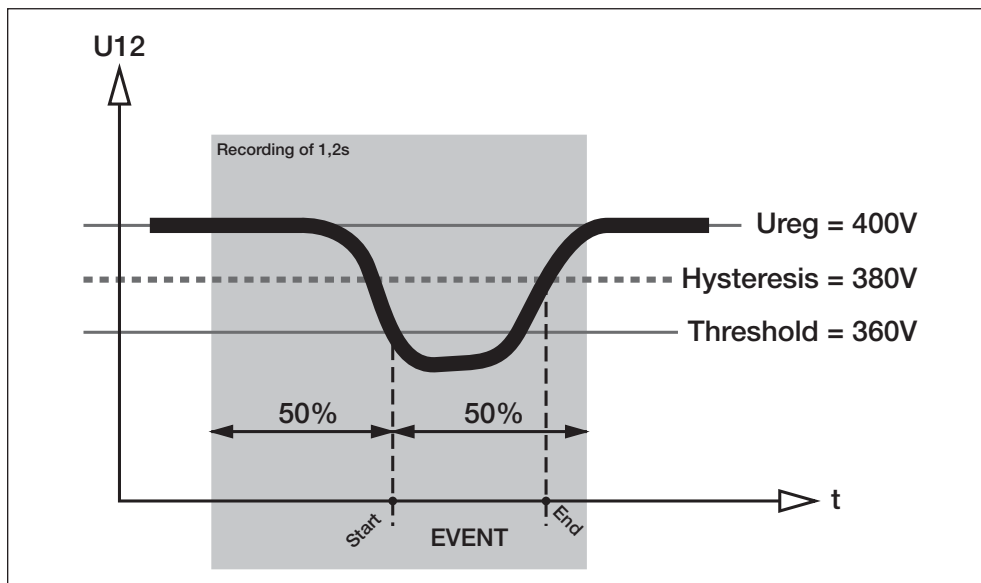

Example : Voltage dips with a 90 % voltage threshold and 5% hysteresis.

THRESHOLD OF VOLTAGE DIPS (SAG) (Example : dAtA SAG = 90%)

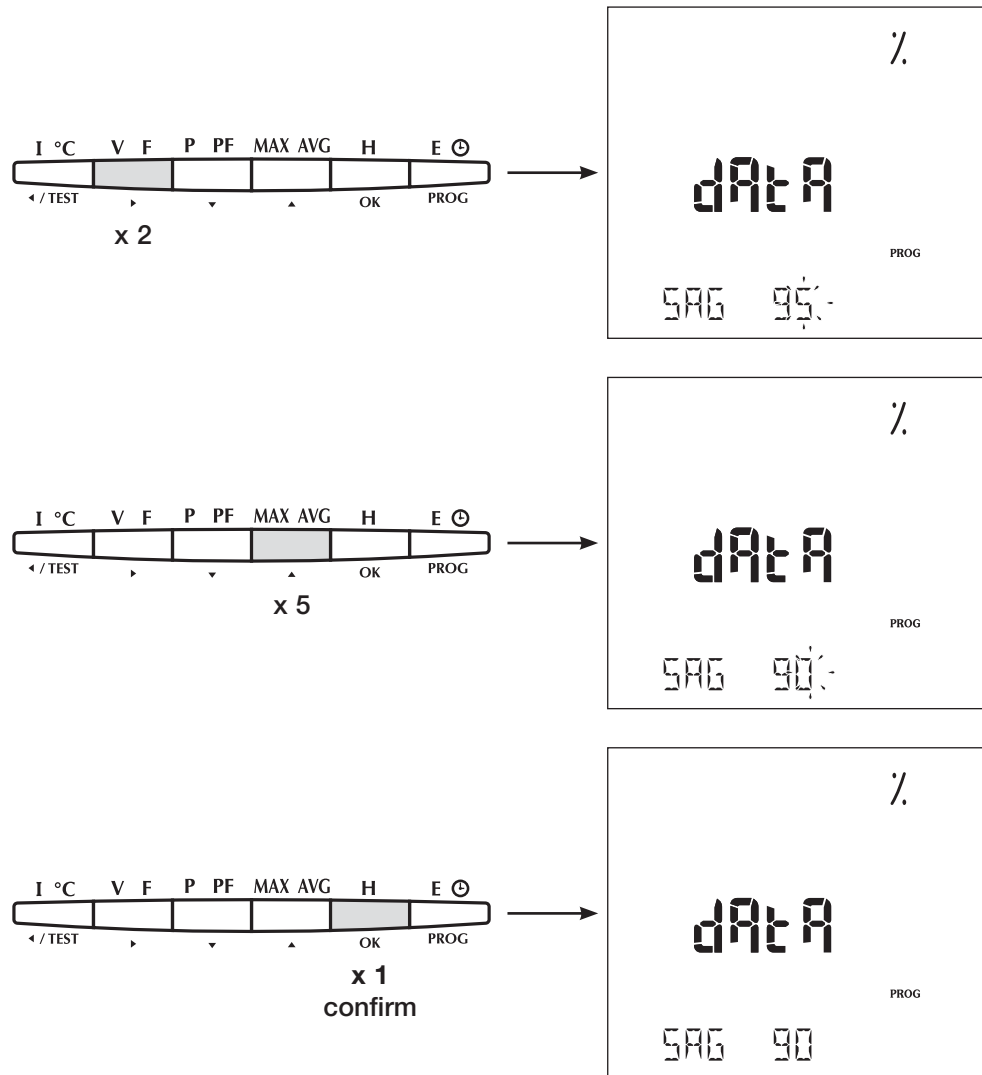

DIRIS A60

PROGRAMMING

HYSTERESIS OF THE VOLTAGE DIP (Example : dAtA HySt SAG = 5%)

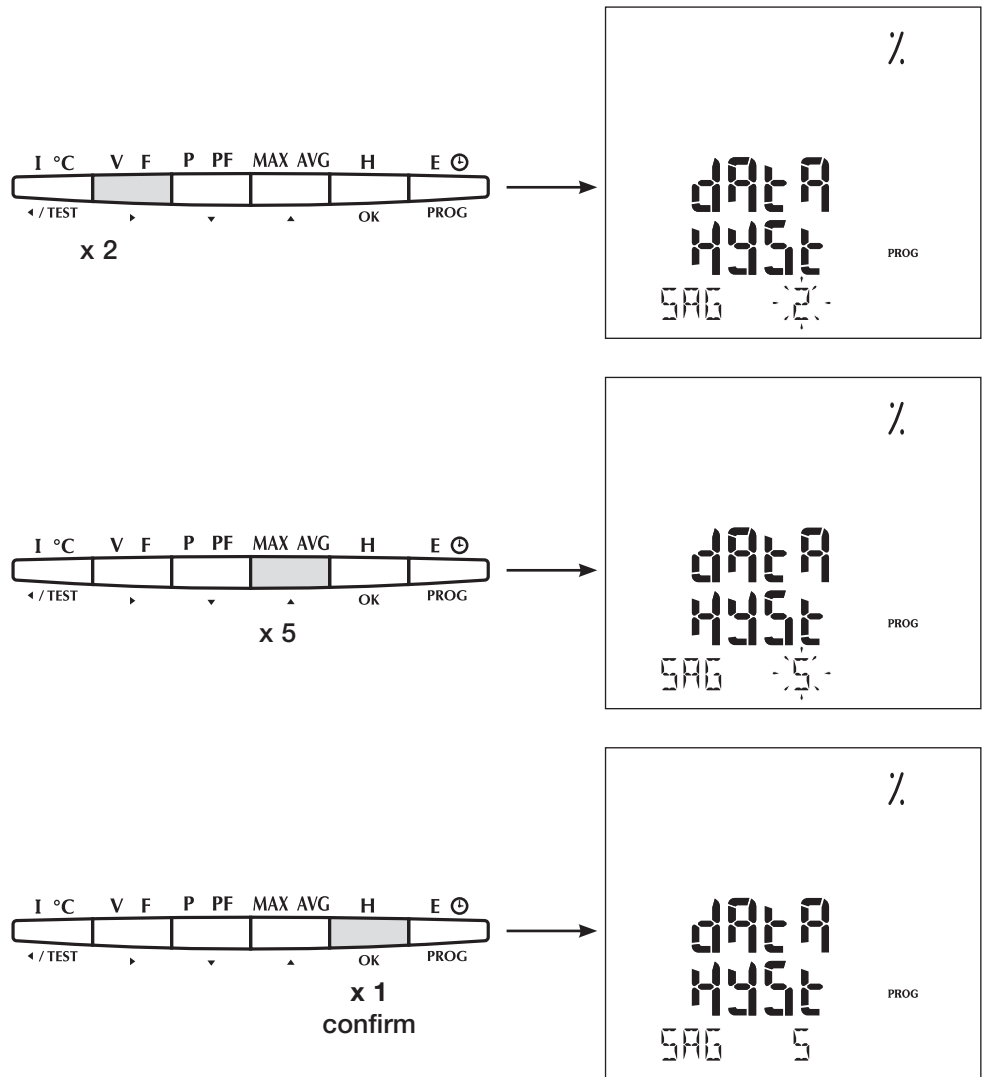

THRESHOLD OF VOLTAGE SWELL (SWELL) (Example : dAtA SWELL = 115 %)

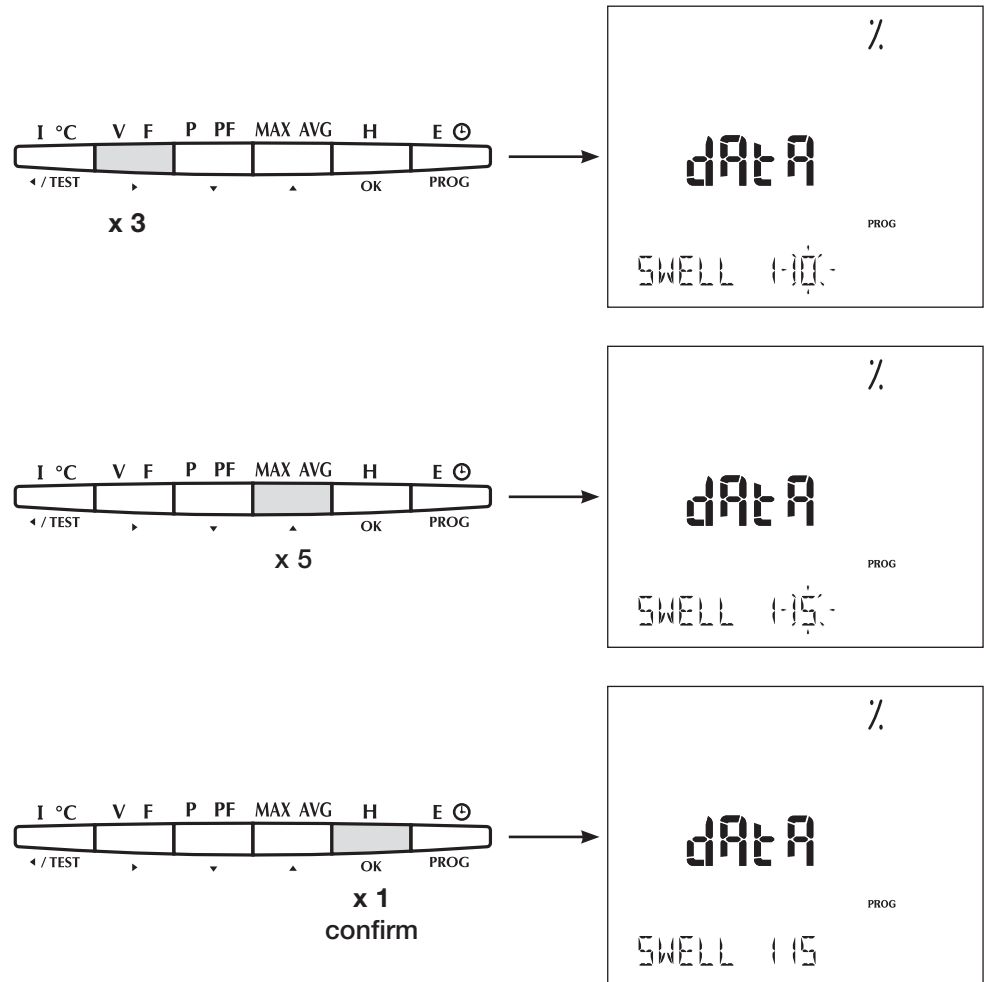

DIRIS A60

PROGRAMMING

HYSTERESIS OF VOLTAGE SWELL (Example: dAtA HySt SWELL = 5%)

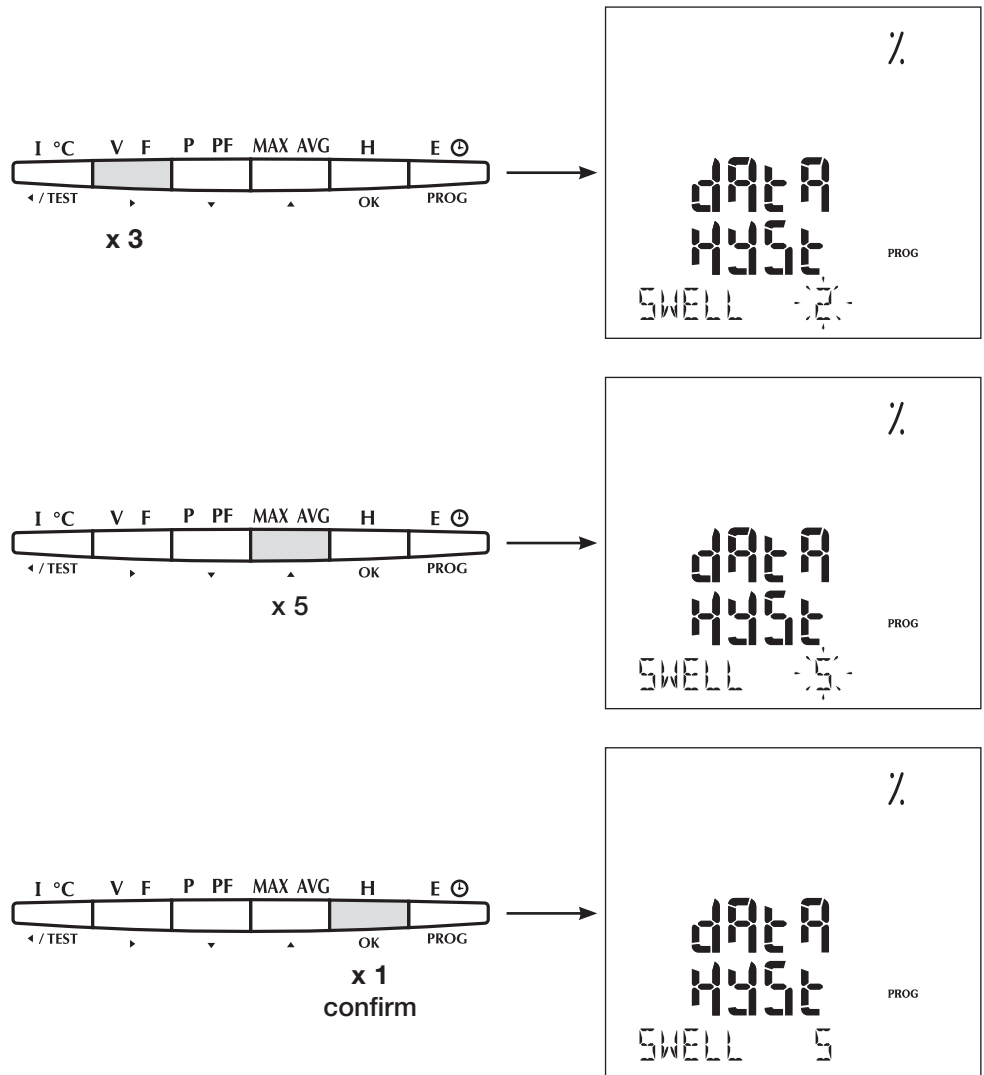

THRESHOLD OF OVER-CURRENTS (Example: dAtA OVER I = 115%)

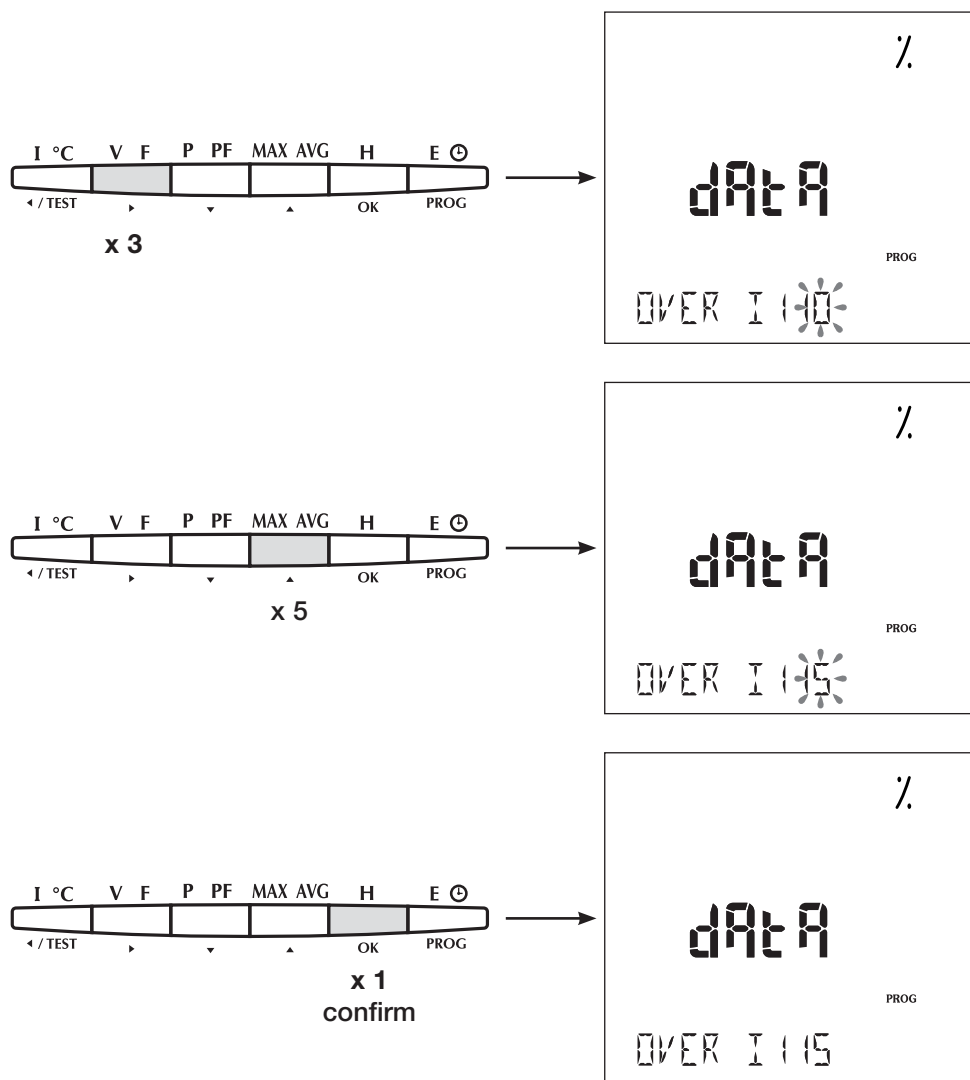

HYSTERESIS OF OVER-CURRENTS (Example: dAtA HySt I = 5%)

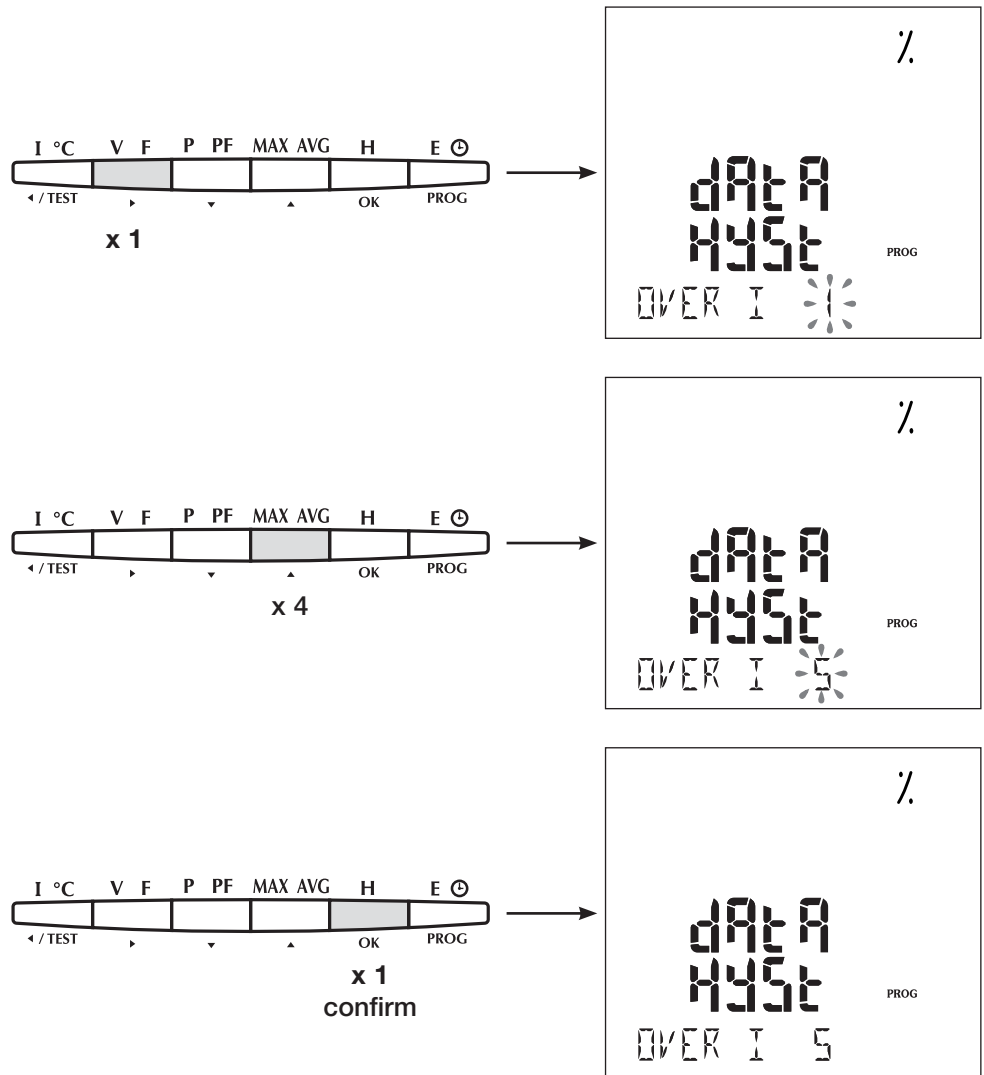

CONFIGURABLE TRIGGER FOR RMS 1/2 CURVES PERIOD

(Example: MOde PRE-POST = 30% - 70%)

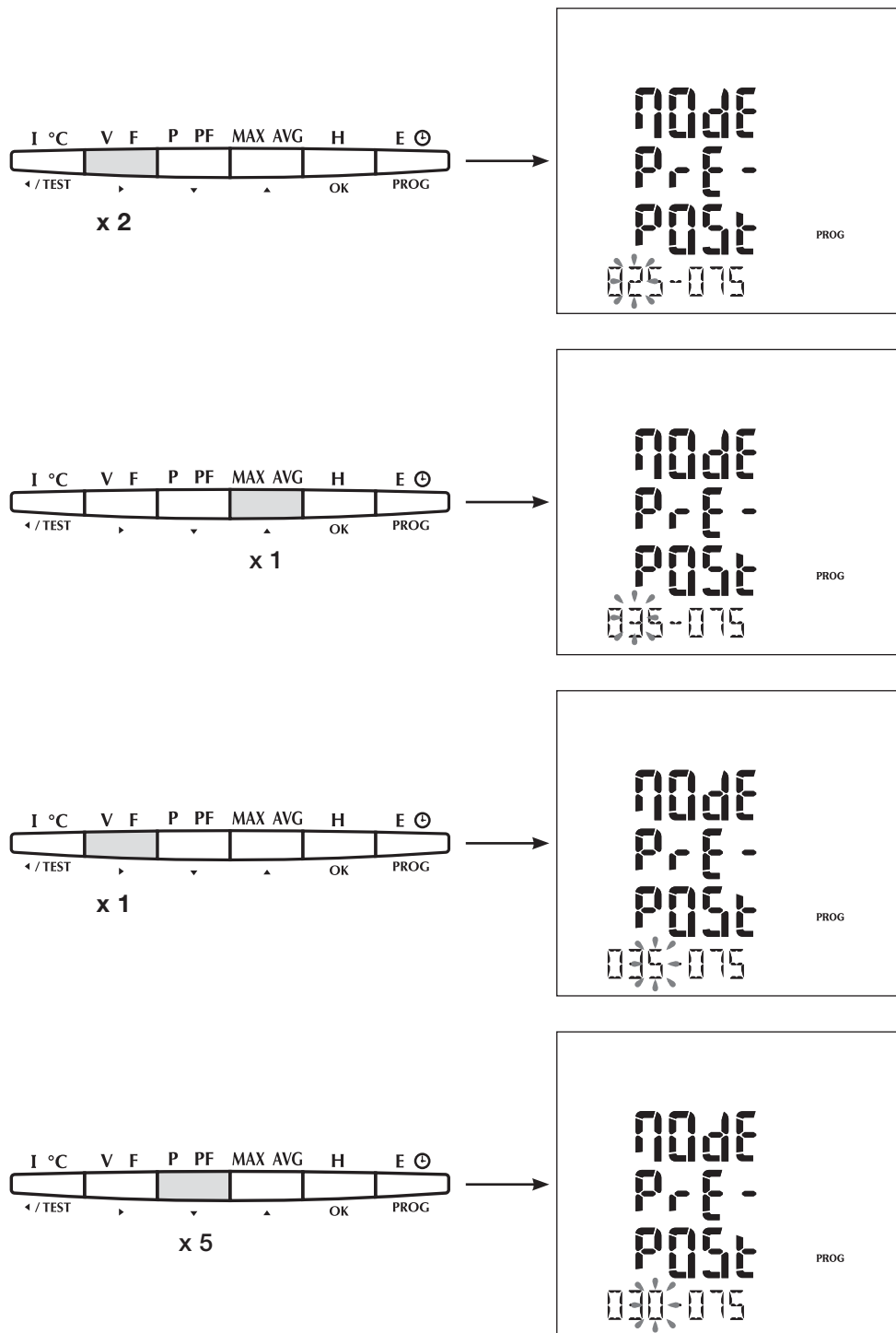

DIRIS A60

PROGRAMMING

TRIGGER CONFIGURABLE POUR LES COURBES RMS 1/2 PERIODE

(Example: M0dE PRE-POST = 30% - 70%)

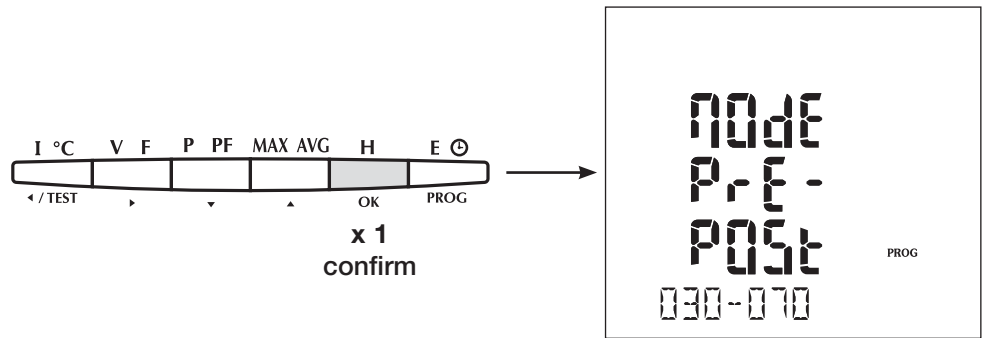

MODIFICATION OF THE DATE / TIME FUNCTION: YES / NO
 (By default G.M.T. time = 0) - (Example: dAtE tIME = YES))

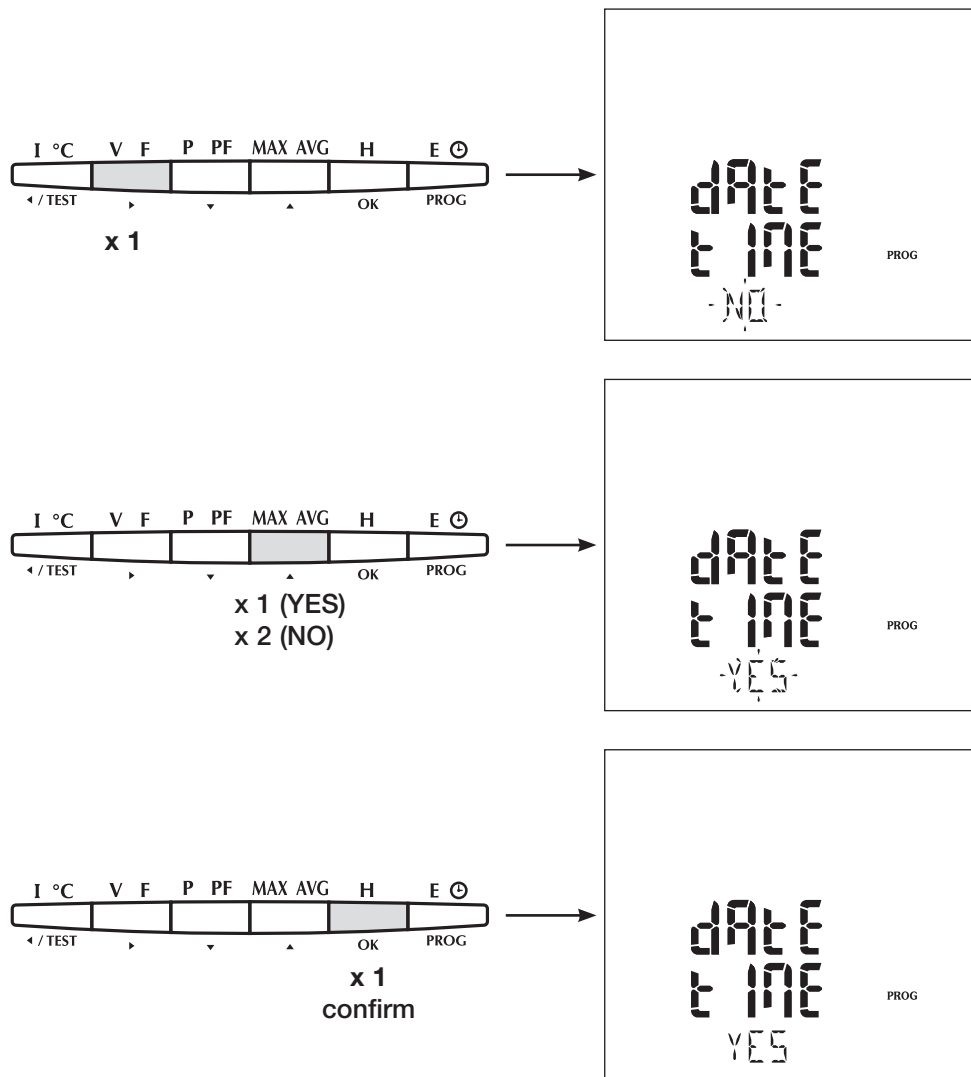

DATE SETTINGS (Example: dAtE = 19-07-05)

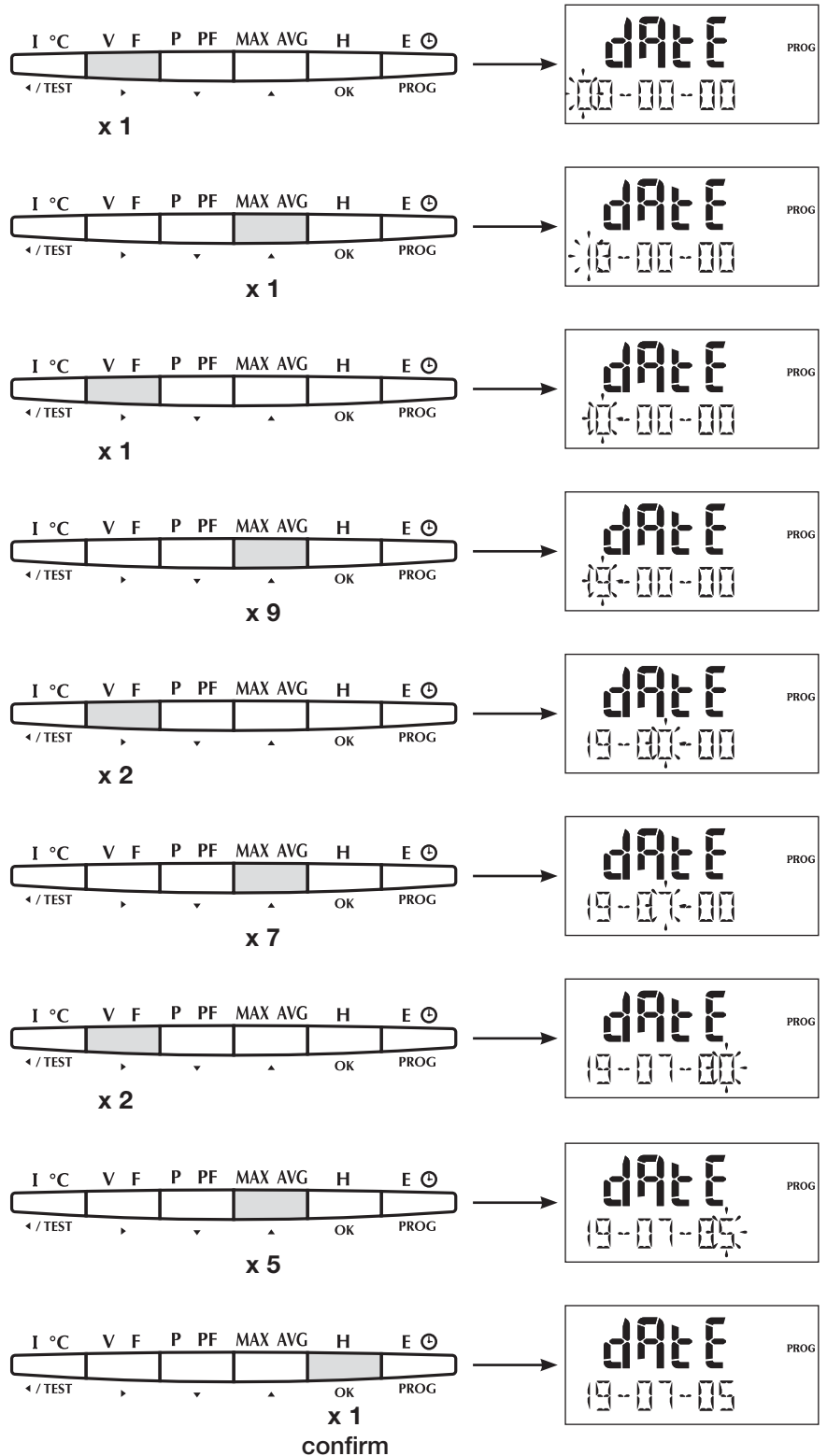

HOUR SETTINGS (Example: tIME 14h02'30")

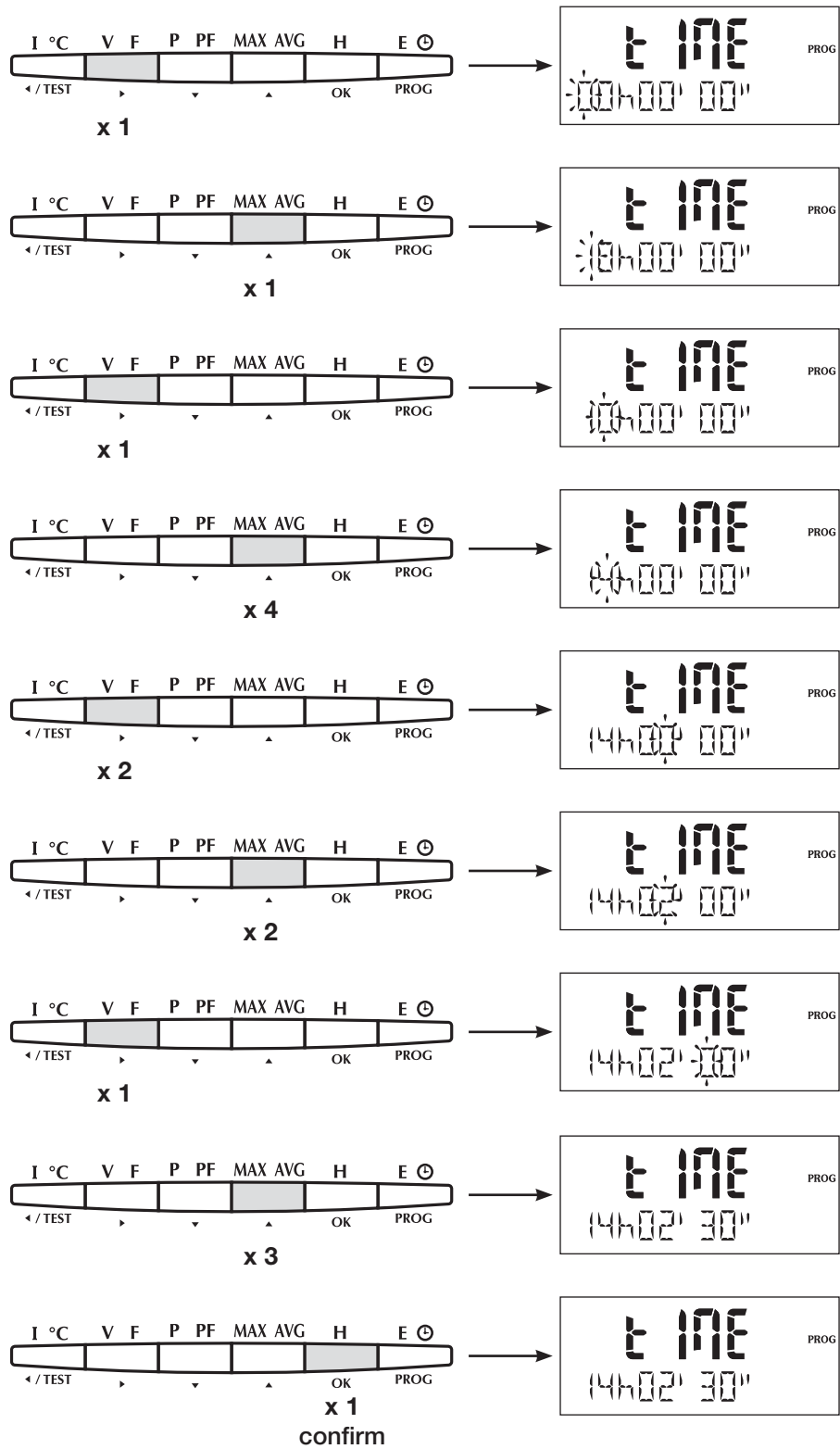

DIRIS A60

PROGRAMMING

MODIFICATION OF THE ACCESS CODE IN THE CONFIGURATION MENU

(Example: CODE = 200)

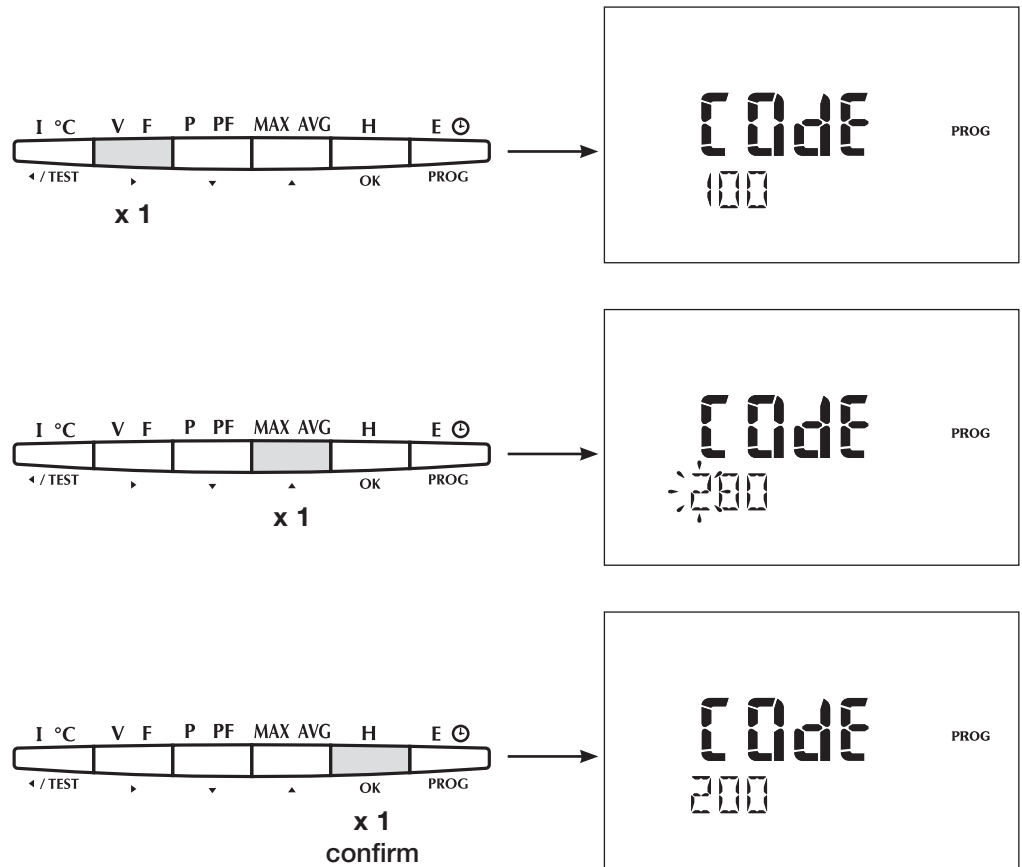

SERIAL NUMBER (Example: SEr1 = 0320100)

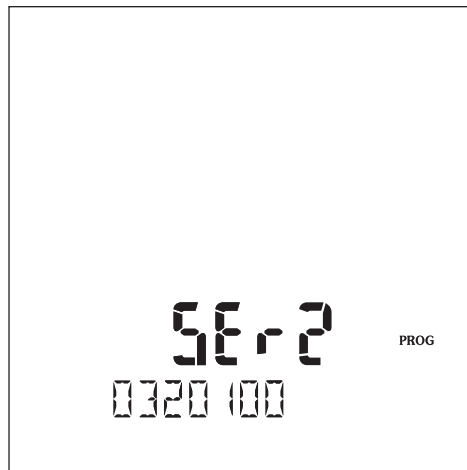
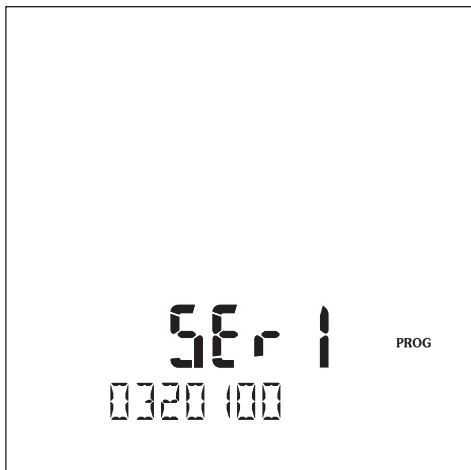

SOFTWAREVERSION (Example : version 100)

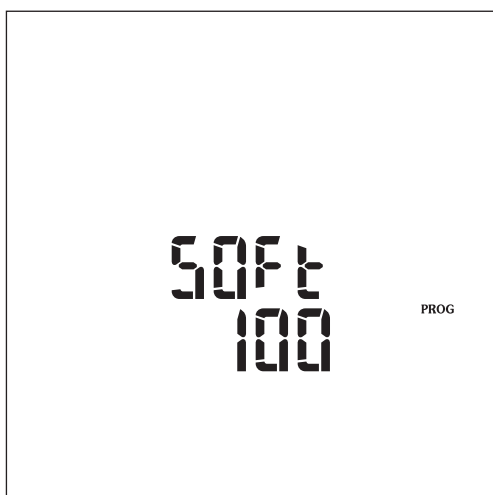

TO QUIT PROGRAMMING

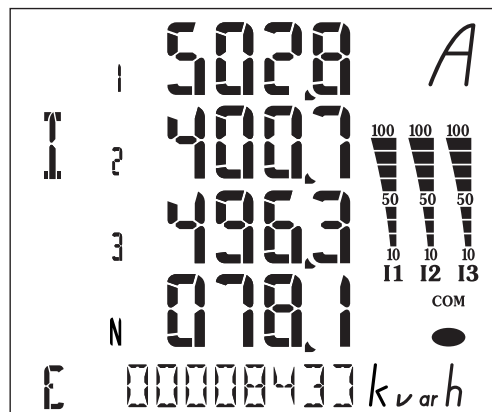
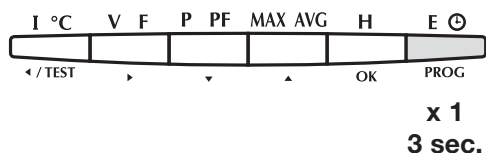

DIRIS A60

OPERATION

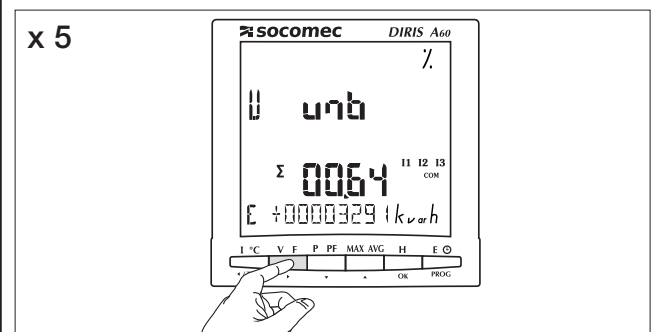
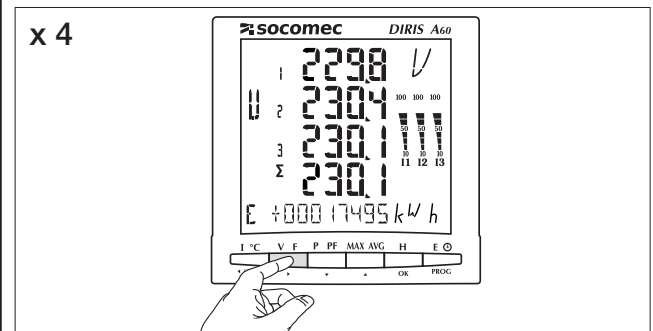
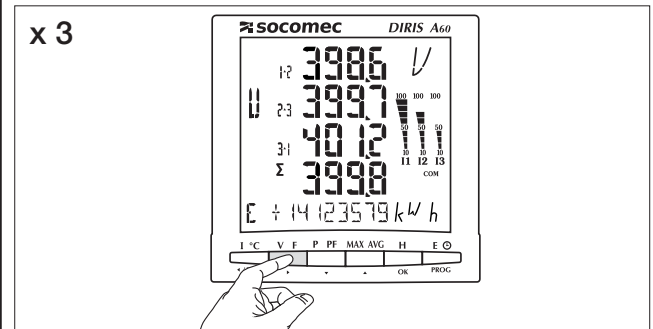
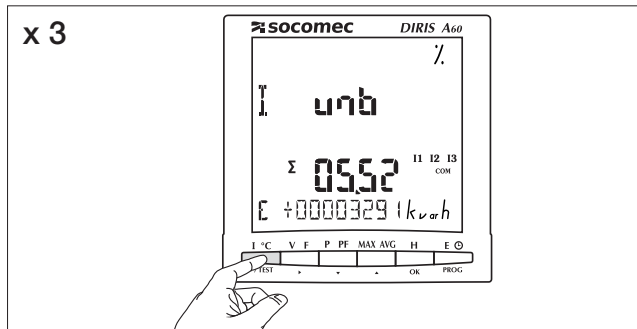
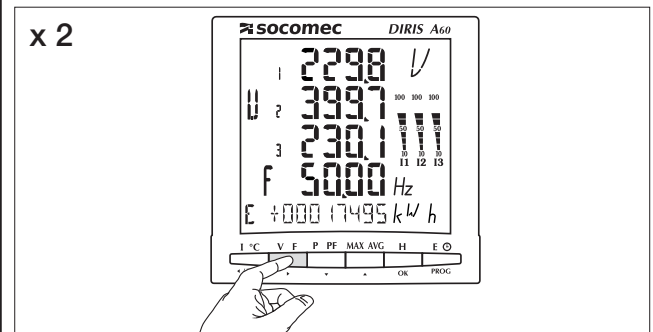
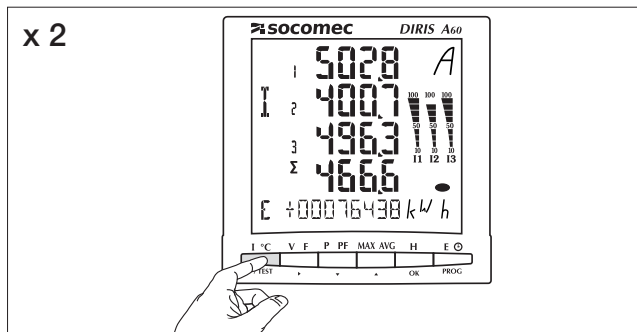
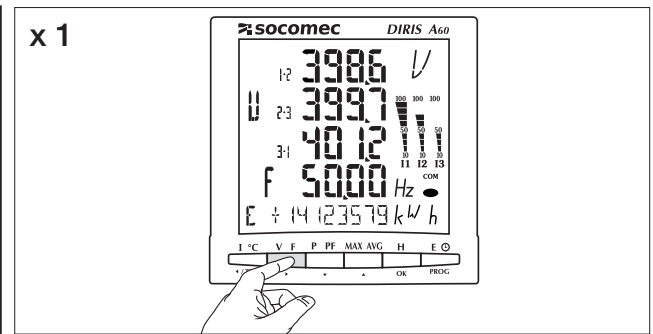
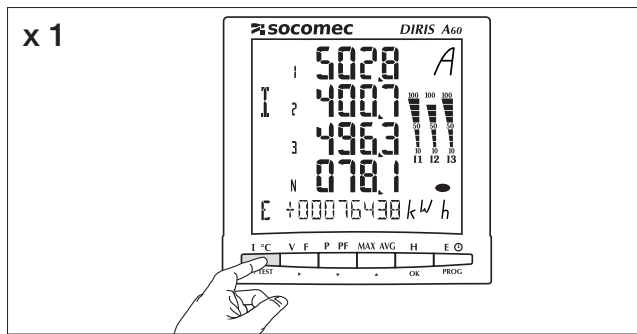

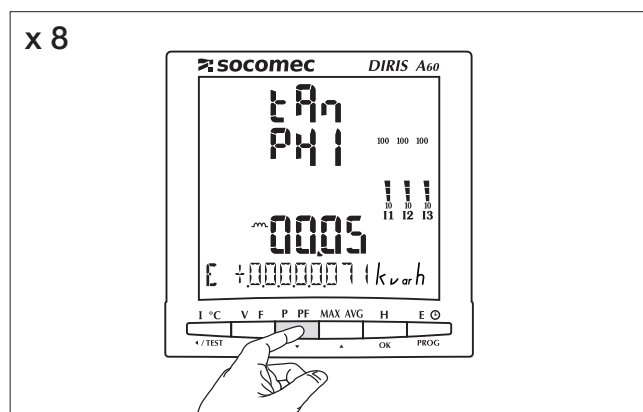
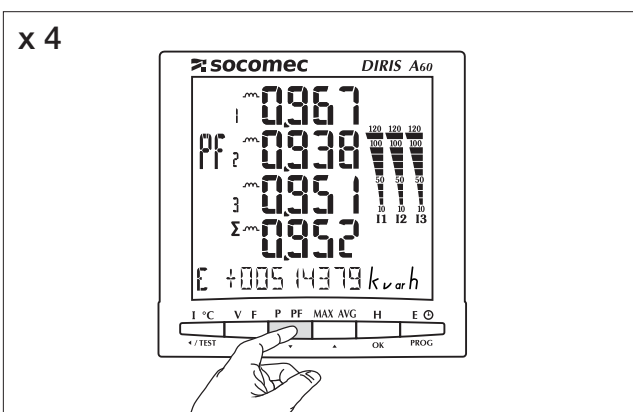
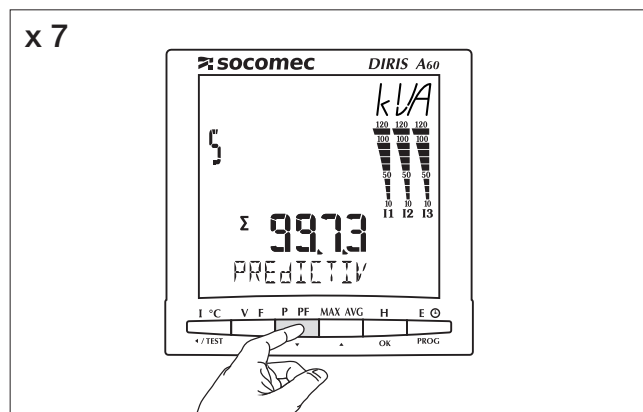
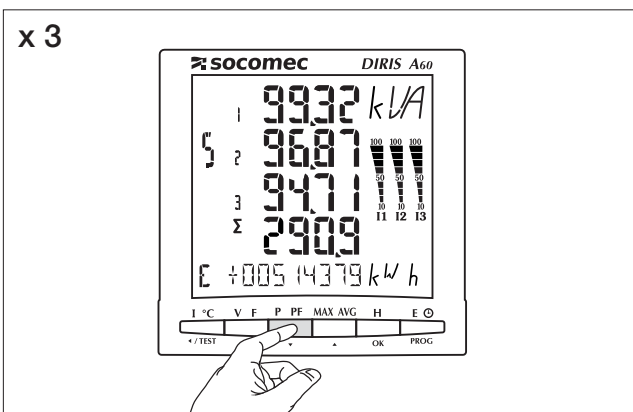
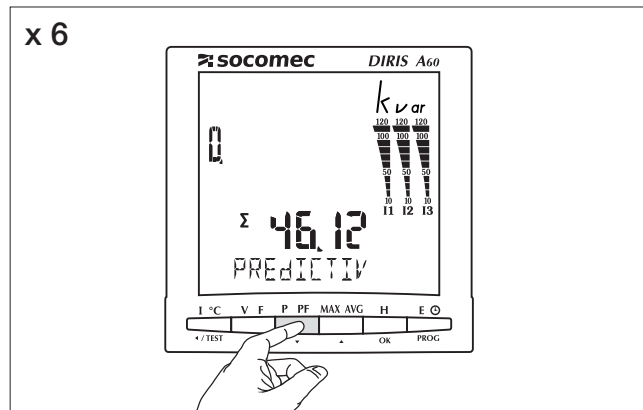
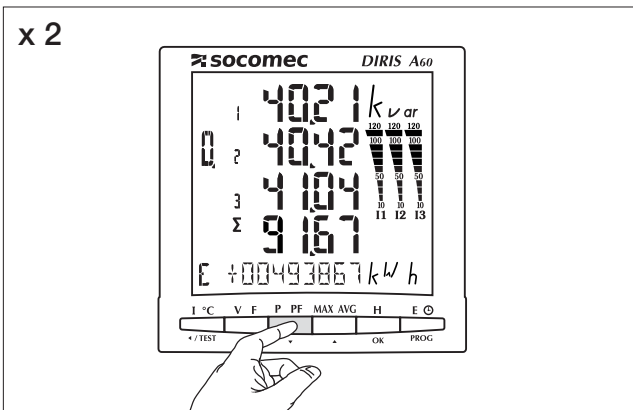
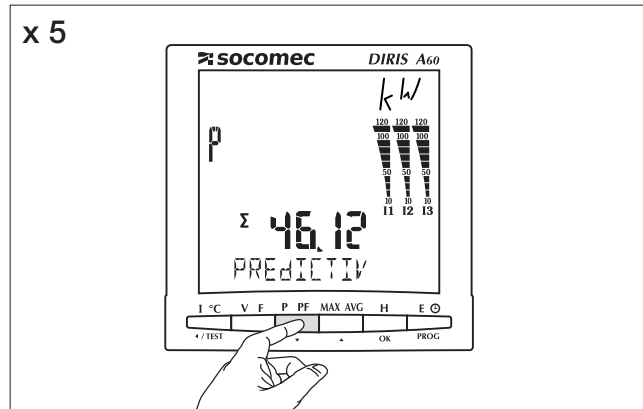
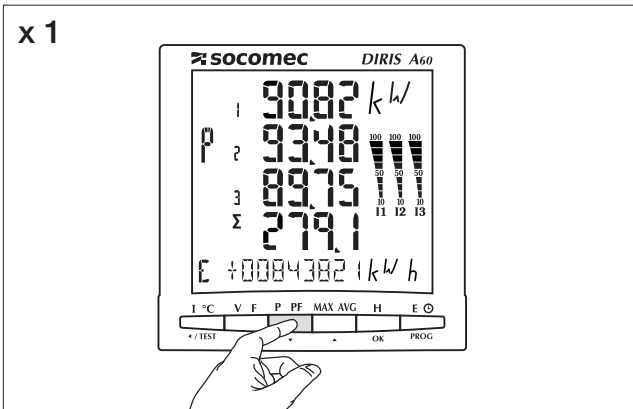

DIRIS A60

OPERATION

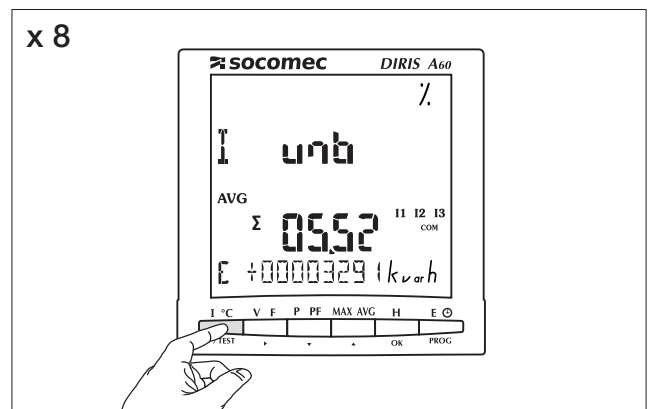
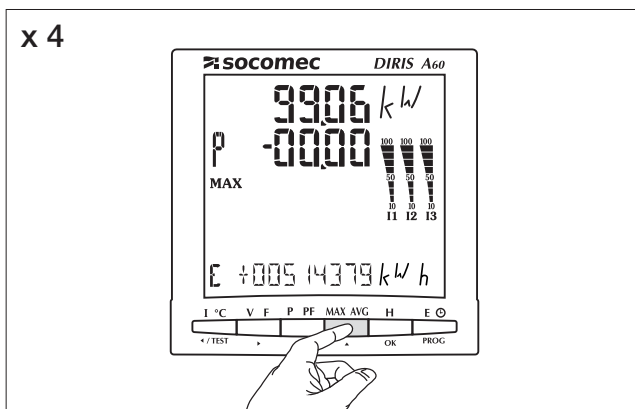
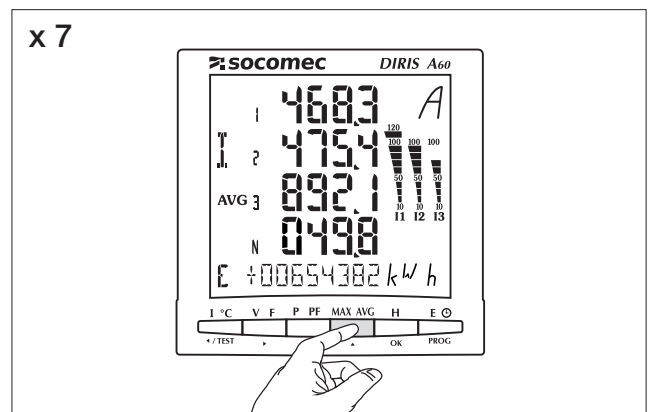
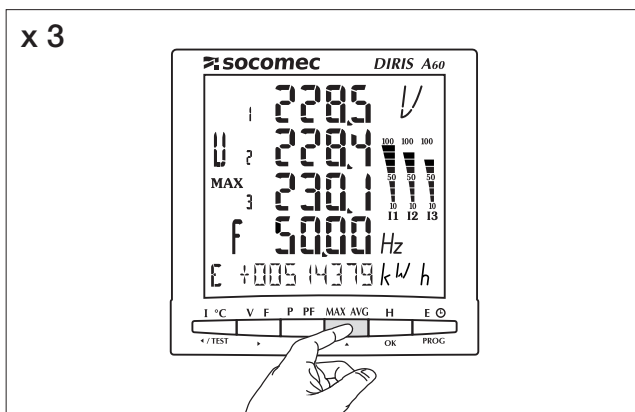
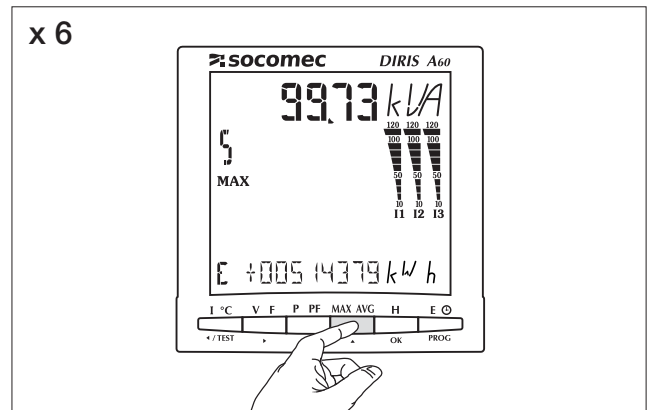
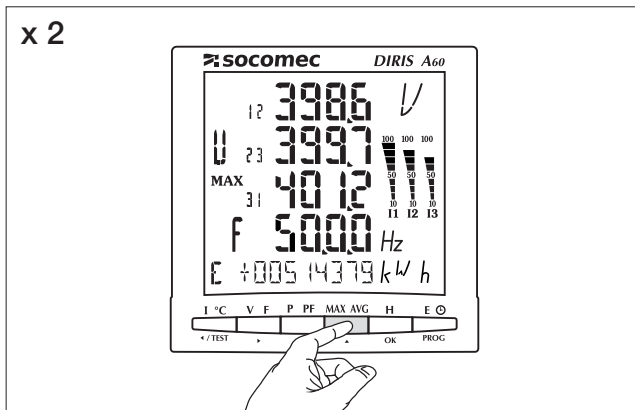
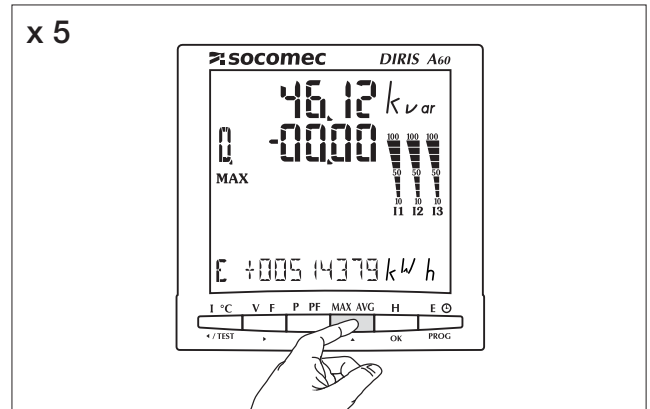
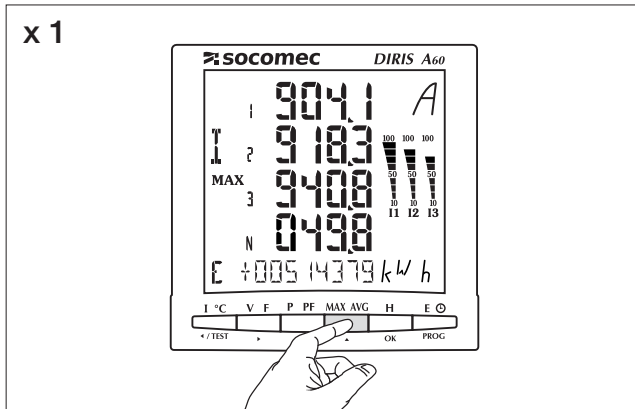

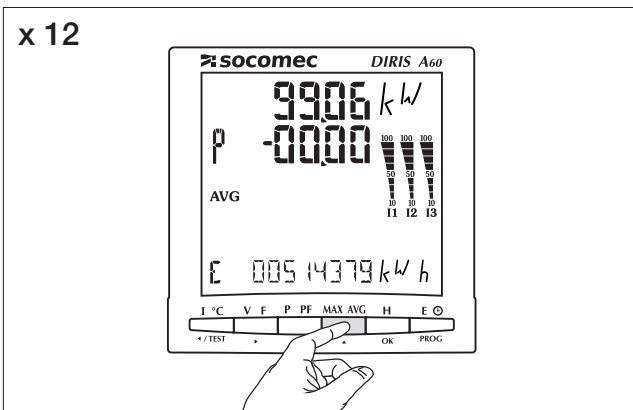
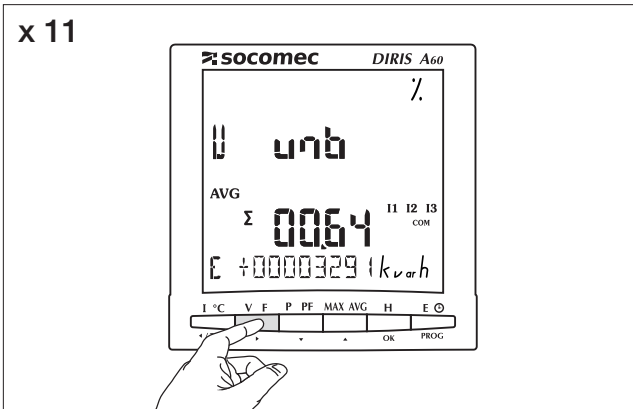
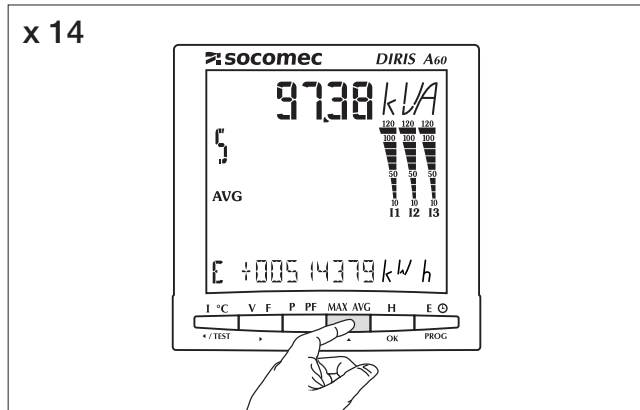
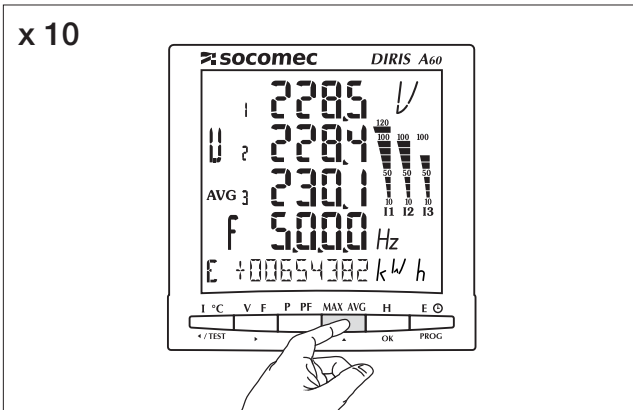
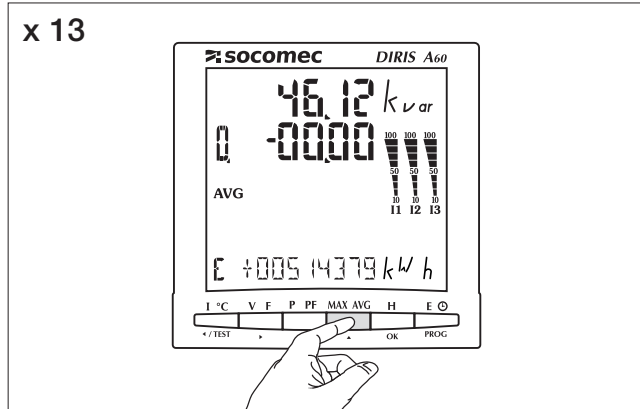
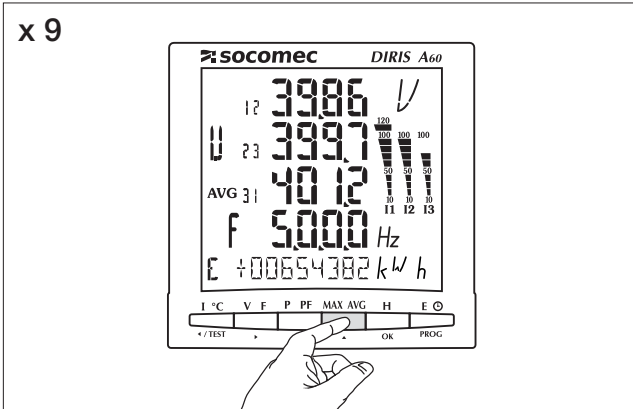

DIRIS A60

OPERATION

x 1

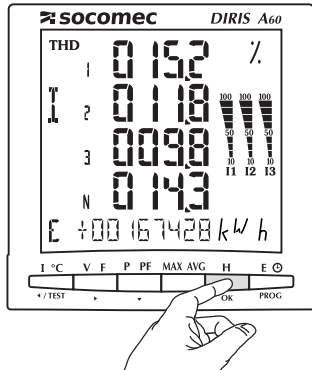

x 13

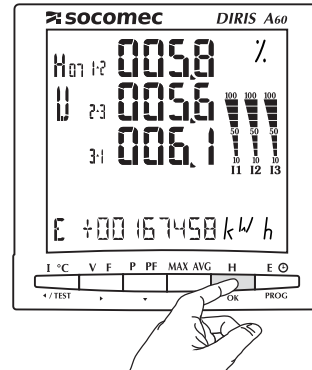

x 2

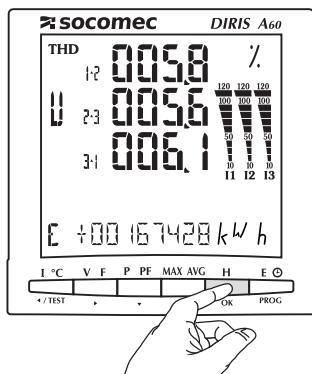

x 21

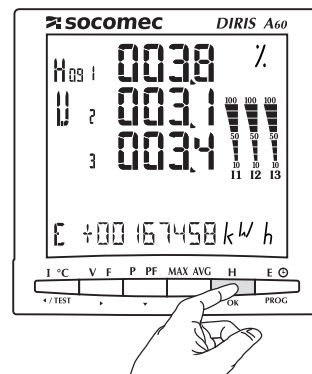

x 3

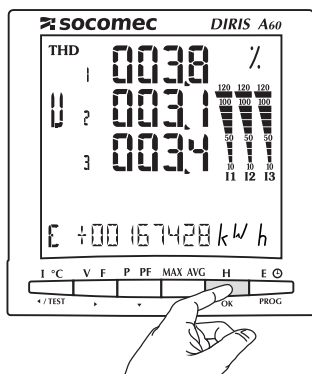

x 4

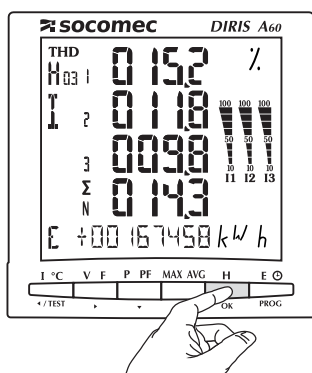

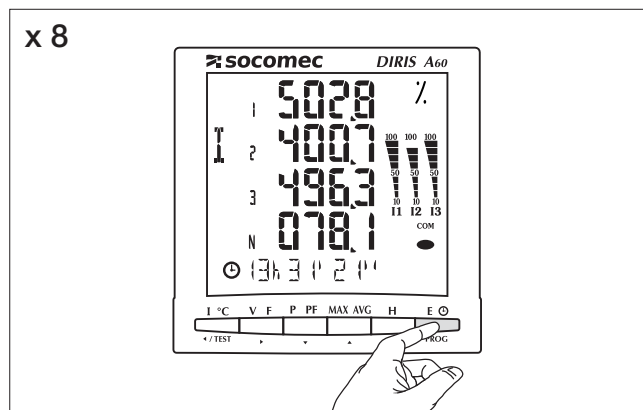
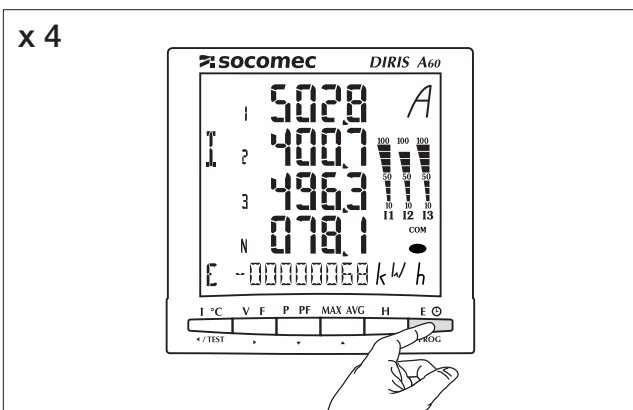
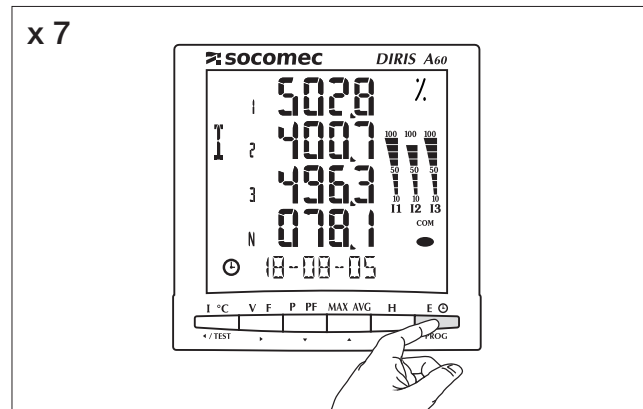
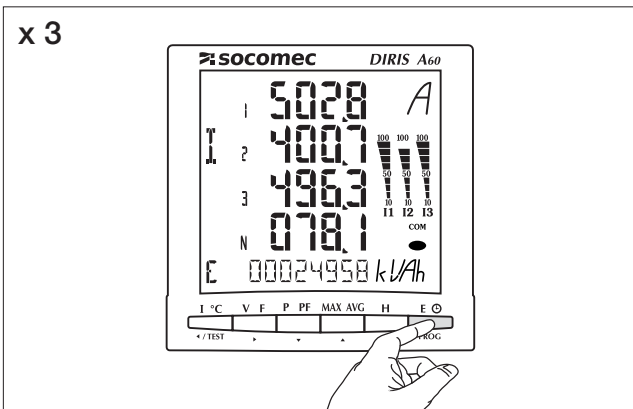
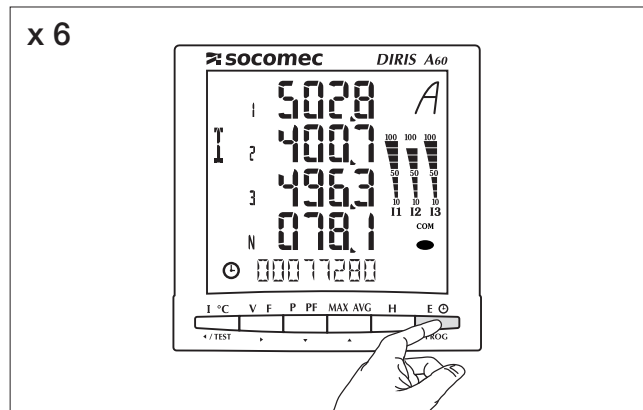
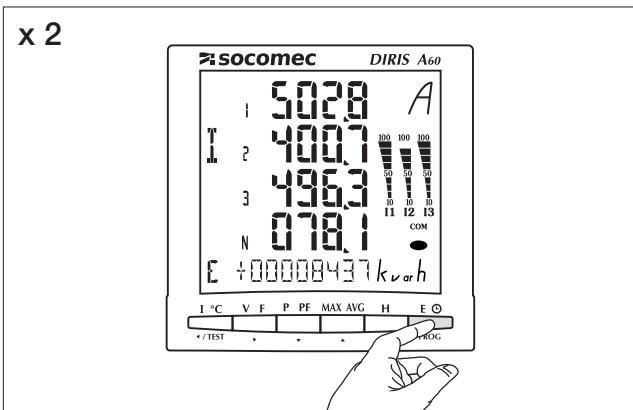
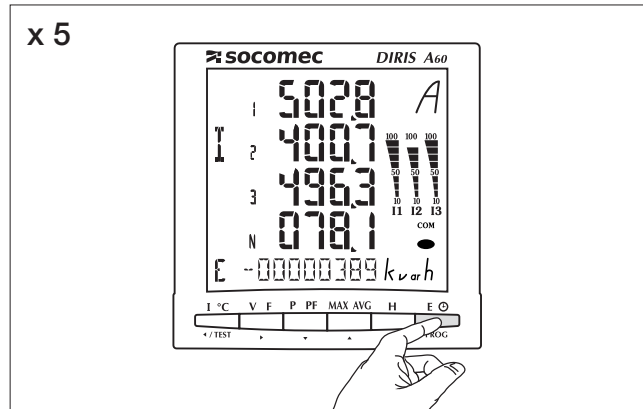
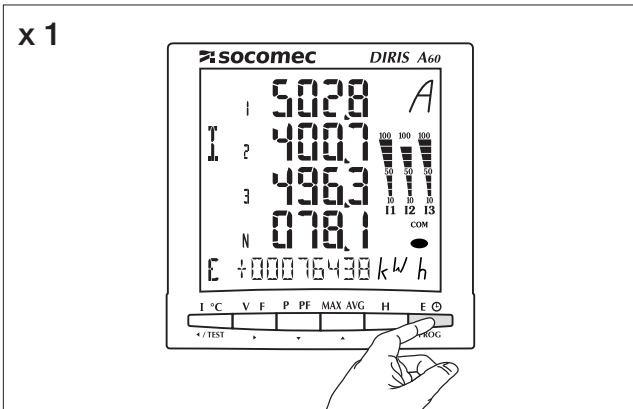

CONNECTION TEST FUNCTION

During the test, the DIRIS must have current and voltage for each of the phases.

In addition to this, the function recognises the PF of the installation as being between $0.6 < PF < 1$. If the PF of the installation is not within this range, this function cannot be used.

In 4 BL/3 BL/2BL/1 BL, the connection of the CTs is controlled only.

In 4NBL and 3NBL the connection as a whole is controlled.

Do check that these are the right conditions:

Err 0 = no error

Err 1 = CT phase 1 inverted

Err 2 = CT phase 2 inverted

Err 3 = CT phase 3 inverted

Err 4 = V1 and V2 voltages inverted

Err 5 = V2 and V3 voltages inverted

Err 6 = V3 and V1 voltages inverted

For the Err 1, Err 2 and Err 3, the modification can be performed automatically by the DIRIS or manually by correcting the current connections.

For the Err 4, Err 5 and Err 6 the modification must be performed manually by correcting the voltage connections.

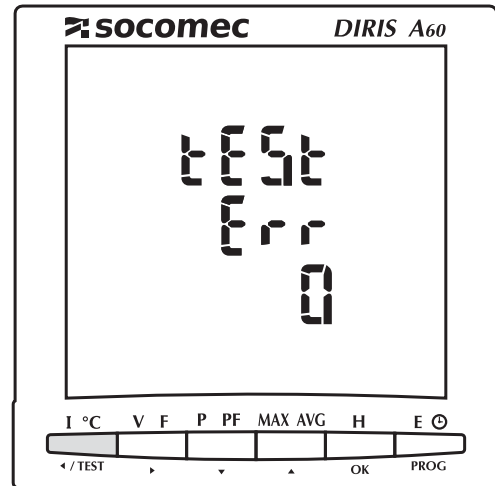

x 1
3 sec.

Example : tEsT Err 0

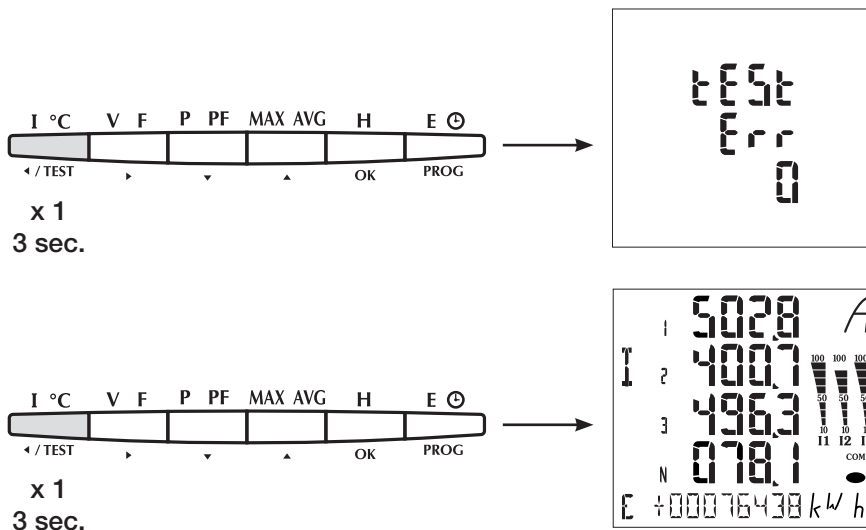

Example : tEsT Err 2

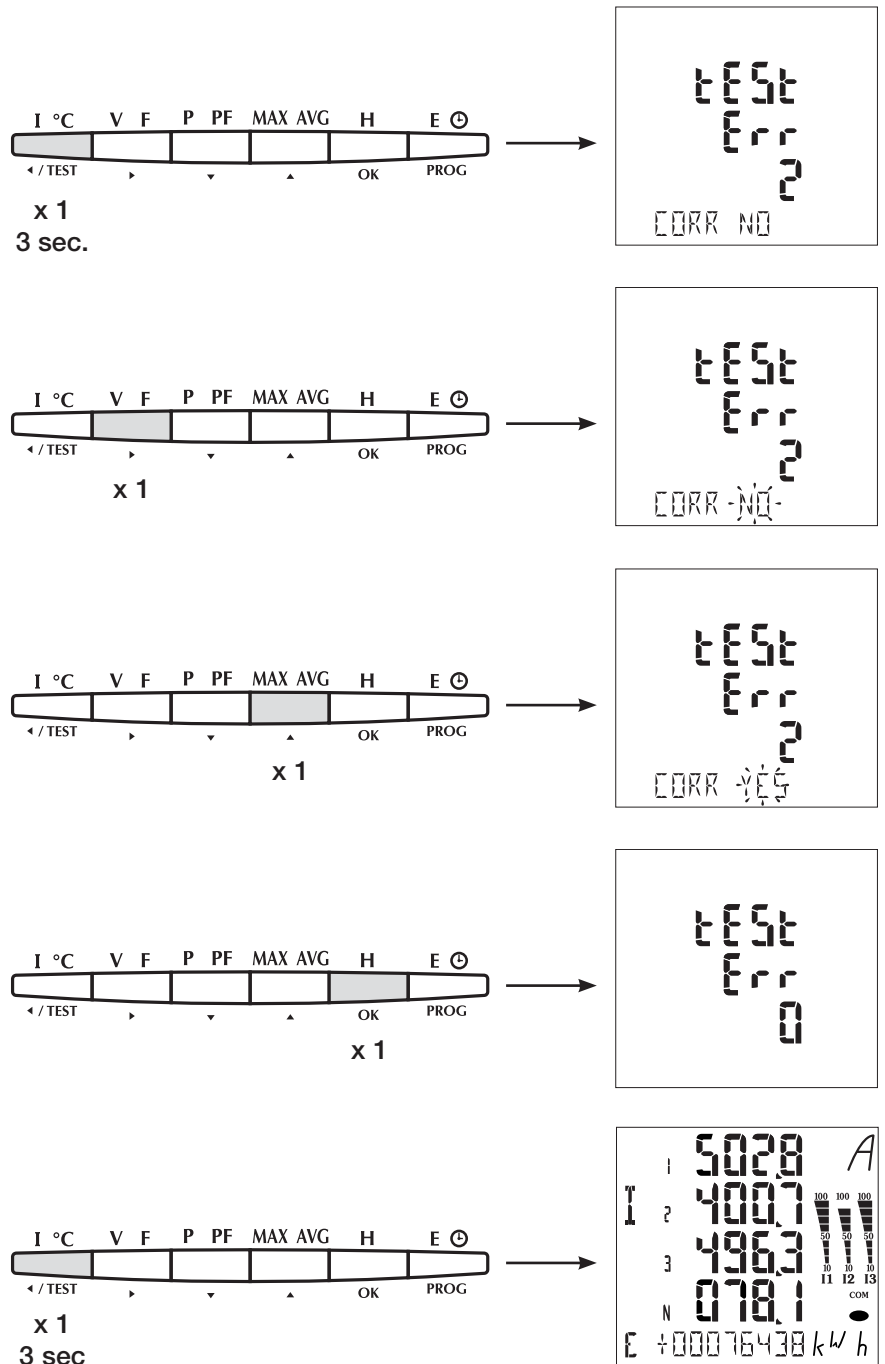

> **second test operation**

This menu is displayed if the product has already been tested. You can run a full test again as explained below.

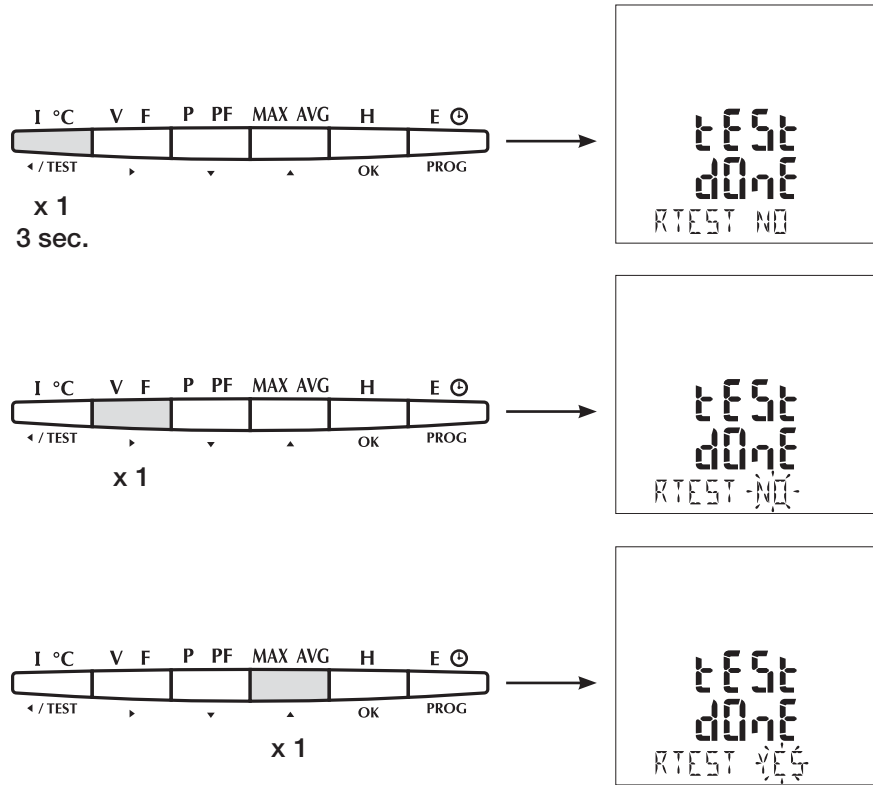

- **Device Switched off**
Check auxiliary supply
- **Backlight switched off**
Check backlight configuration in set up menu
(p. 24)
- **Voltage = 0**
Verify the connections
- **Current = 0 or incorrect**
Verify the connections
Verify the configuration of CT's in set up
- **Powers, power-factor and energies false**
Use the test connection function (p. 48)
- **Phases missing on Display**
Check the Network configuration
(in set up menu) (p. 13)

DIRIS A60

CARACTÉRISTIQUES TECHNIQUES

CASE

Dimensions:	97 x 97 x 80 mm 97 x 97 x 80 mm with all optional modules (DIN 43700)
Connection:	via 2.5 mm ² disconnectable terminals (voltage and others) and 6 mm ² fixed terminals (current)
IP index:	IP52 (front panel) and IP30 (case)
Weight:	465 gr.

DISPLAY

Type :	Backlit LCD display
--------	---------------------

MEASUREMENTS

Three-phase (3 or 4 wires), two-phase (2 wire) and single-phase networks

VOLTAGE (TRMS)

Direct measurement:	from 50 to 690 V AC (phase/phase) from 28 to 400 V AC (phase/neutral)
Measurement via PT:	• Primary: up to 500 kV • Secondary: 60, 100, 110, 115, 120, 173 and 190 V AC
Display and resolution	from 0 to 500.0 kV
Permanent overload:	760 V AC
Update period:	1 second

CURRENT (TRMS)

Via CT with:	• Primary: up to 10000 A • Secondary: 1 or 5 A
Minimum measuring current	3mA with U (Ph/N) > 28 VAC
Input consumption:	< 0.3 VA
Display:	from 0 to 11 kA (1.1 times the primary value)
permanent overload:	10 A
intermittent overload:	10 In / 1 second
Update period:	1 second
Maximum ratio KI x KU:	10 000 000

POWER

Total:	0 to 8000 MW/Mvar/MVA
Update period:	1 second

FREQUENCY

	from 45,0 to 65,0 Hz
Update period:	1 second

PULSE INPUT

110 to 400 V AC 50/60 Hz	± 10 %
120 to 350 V DC	± 20 %
12 to 48 V DC	-6 % / + 20 %
Consumption :	< 10 VA

ALIMENTATION AUXILIAIRE IEC / CE

Forward voltage max.	30 V DC
Forward voltage min.	10 V DC
Reverse voltage max.	30 V DC
Galvanic insulation	3 kV
Minimum pulse width	1s
Max number of manoeuvres	10 ⁸

CONFORMITE IEC 61557-12 Edition 2 (07/2008)			
PMD CHARACTERISTICS			
Type of specification	Examples of possible specification values		Other additional characteristics
Supply quality evaluation function (optional)	-		-
PMD classification	SD		-
Setpoint	K55		-
Humidity + Altitude	-		-
Operating performance class for active power or active energy (if function available)	0,5		-
CHARACTERISTICS OF THE FONCTIONS			
Symbol of the functions	Measurement range	Operational performance category, in accordance with CEI 61557-12 depending on the KI	Other additional characteristics
P	1% to 120% In	0,5	-
Qa, Qv	1% to 120% In	0,5	-
Sa, Sv	1% to 120% In	1	-
Ea	0 to 99999999 kW/h	0,5	-
Era, Erv	0 to 99999999 kVar/h	2	-
Eapa, Eapv	0 to 99999999 kW/h	1	-
f	45 to 65 Hz	0,1	-
I	5% to 120% In	0,2	-
In, Inc	5% to 120% In	0,2	Calculated
U	50 to 600Vac ph/ph	0,2	30 to 350Vac Ph/n
PFa ,PFv	0,5ind to 0,8cap	0,5	-
Pst, Plt	Unavailable function on A60		
Udip	5 to 100% Un	0,5	-
Uswl	100 to 120% Un	0,5	-
Utr	Unavailable function on A60		
Uint	Unavailable function on A60		
Unba	Unavailable function on A60		
Unb	Unavailable function on A60		
Uh	Fn = 50Hz - rank 1 to 41	1	-
THDu	Fn = 60Hz - rank 1 to 35	1	-
THD-Ru	Unavailable function on A60		
Ih	Fn = 50Hz - rank 1 to 55	1	-
THDi	Fn = 60Hz - rank 1 to 51	1	-
THD_Ri	Unavailable function on A60		
Msv	Unavailable function on A60		

CHARACTERISTICS OF THE "EVALUATION FUNCTIONS OF THE QUALITY OF SUPPLY"			
Symbol of the functions	Measurement range	Operational performance category, in accordance with CEI 61557-12 depending on the KI	Other additional characteristics
f	45 to 65 Hz	0,1	-
I	5% to 120% In	0,2	-
In, Inc	5% to 120% In	0,2	Calculated
U	50 to 600Vac ph/ph	0,2	30 to 350Vac Ph/n
Pst, Plt	Unavailable function on A60		
Udip	5 to 100% Un	0,5	-
Uswl	100 to 120% Un	0,5	-
Uint	Unavailable function on A60		
Unba	Unavailable function on A60		
Unb	Unavailable function on A60		
Uh	Fn = 50Hz - rank 1 to 41 Fn = 60Hz - rank 1 to 35	1	-
Ih	Fn = 50Hz - rank 1 to 55 Fn = 60Hz - rank 1 to 51	1	-
Msv	Unavailable function on A60		

CE MARKING

DIRIS A60 COMPLIES WITH THE EUROPEAN GUIDELINES FOR:

- ELECTROMAGNETIC COMPATIBILITY NO. 2004/108/CE DATED 15 DECEMBER 2004.
- LOW VOLTAGE NO. 2006/95/CE DATED 12 DECEMBER 2006.

CLIMATE

OPERATING-TEMPERATURE RANGE:	IEC 60068-2-1/IEC 60068-2-2 -10 °C to +55 °C
STORAGE TEMPERATURE RANGE:	IEC 60068-2-1/IEC 60068-2-2 -20 °C to +70 °C
HUMIDITY:	IEC 60068-2-30 - 95 % HR
SALINE FOG:	IEC 60068-2-52 - 2,5 % NaCl

MECHANICAL CHARACTERISTICS

Vibration from 10 AND 100 HZ :	IEC 60068-2-6 - 2 G
--------------------------------	---------------------

INSULATION

ELECTRIC SECURITY:	IEC 61010-1
INSTALLATION CATEGORY:	III (300VAC PH/N)
DEGREE OF POLLUTION:	2

GLOSSARY OF ABBREVIATIONS

1BL	Single-phase network, 2 fils avec 1 TC
2BL	Two-phase network, 2 fils avec 1 TC
3BL	Balanced three-phase network, 3 wires with 1 TC
3NBL	Unbalanced three-phase network, 3 wires with 2 or 3 TC
4BL	Balanced three-phase network, 4 wires with 1 TC
4NBL	Unbalanced three-phase network, 4 wires with 3 or 4 TC
AUX	Auxiliary supply
AVG	Average value
bACLIt	LCD start-up (U or I or Aux. Condition)
Ct	Current transformers
Ct In	Neutral current transformer
dAtA	Event storing
dAtE	Days / months / years
EA-	Negative active power (-kWh)
EA+	Positive active power (+kWh)
ER-	Negative reactive power (-kvarh)
ER+	Positive reactive power (+kvarh)
ES	Apparent power (-kVAh)
EXT	External
HySt	Hysteresis
HOUr	Hour run meter
HOUr	Hour meter start-up (U or I or Aux. condition)
INT	Internal
MAX	Maximum mean values
MAX P-	Active power maximum negative mean value
MAX P+	Active power maximum positive mean value
MAX Q-	Reactive power maximum negative mean value_A faire valider
MAX Q+	Reactive power maximum positive mean value
MAX S	Effective power maximum mean value
MOdE PrE-POST	Ratio locating the event on the record curves
nEt	Network type
NO	No
P+	Positive power consumption demand
P-	Active power consumption demand
PF	Power factor
Q+	Positive reactive power consumption demand
Q-	Negative reactive power consumption demand
rSET	Reset
SAG	Voltage dip
SErI	Serial number
SOft	Software version
SWELL	Overvoltage
tAn PHI	PHI tangent
THD I	Current harmonic distortion rate
THD In	Neutral current distortion rate
THD U	Phase-to-phase voltage distortion rate
THD V	Phase-to-neutral voltage distortion rate
tIME	Hours / minutes / seconds
tIME	Synchronisation period
tIME 4I	Integration times for mean and maximum current values
tIME F	Integration times for mean and maximum frequency values
tIME P/Q/S	Integration times for mean and maximum power values
tIME U	Integration times for mean and maximum voltage values
TOP	Synchronizing pulses
unb	Unbalance
Ut	Voltage transformer
U nOM	Nominal voltage
Ut PR	Voltage transformer primary
Ut SE	Voltage transformer secondary
YES	
⌚	Hour run meter

HEAD OFFICE

SOCOMEK GROUP

S.A. SOCOMEK capital 11 302 300 €

R.C.S. Strasbourg B 548 500 149

B.P. 60010 - 1, rue de Westhouse - F-67235 Benfeld Cedex - FRANCE

INTERNATIONAL SALES DEPARTMENT

SOCOMEK

1, rue de Westhouse - B.P. 60010

F - 67235 Benfeld Cedex - FRANCE

Tel. +33 (0)3 88 57 41 41 - Fax +33 (0)3 88 74 08 00

scp.vex@socomec.com

www.socomec.com

This document is not a contract. SOCOMEK reserves the right to modify features without prior notice in view of continued improvement.