



The new alternative to cutting pipes and mechanical meters from Micronics, for simple, low cost flow measurement from outside the pipe!

The U1000 is an ultrasonic permanent/fix clamp-on flow metering solution for measuring preset flow rate – l/m with a volume pulse output in litres and with a 4-20mA flow rate signal, which can be used as a stand alone meter or as an integral part of an aM&T or BEM's system.

Simple to install – clamp-on to the pipe, connect power and enter the pipe diameter, no specialist skills or tools required!

A cost effective alternative to traditional in-line meter installation, plus dry servicing, providing minimum downtime and maximum availability!

Compact, rugged and reliable, the U1000 has been designed to provide sustained performance in industrial environments.



- Metered liquid flow rate and volume
- Easy to install
- Clamp-on sensors
- Lower installed cost than in-line meters



For further information please visit:
www.micronicsflowmeters.com
or call

+44 (0)1628 810456

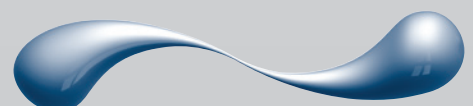

micronics
Through measurement comes control



INDUSTRIES:

- Building Services
- Energy Management
- Water Treatment
- Chemical
- Pharmaceutical
- Petrochemical
- Food

RECOMMENDED FOR:

- Hot water < 85°C
- Chilled water
- Potable water
- Demineralised water

APPLICATION/USE:

- Hot water metering and flow measurement
- Flow measurement for heat metering
- Chilled water metering and flow measurement
- Flow measurement for chilled water energy metering
- Potable water metering and flow measurement
- Process water metering and flow measurement
- Ultrapure water measurement

U1000 - Permanent Ultrasonic Liquid Flow Meter



U1000 Specification

Accuracy: +/-1-3% of flow reading for >0.3m/s

Flow Velocity Range: 0.1 to 10m/s

Pipe Range: 50-150mm Nominal Bore

Water Temp Range: 0°C to 85°C

Flow Rate Output: Opto Isolated 4-20mA

Volume Output: Pulse or Frequency

Outputs preset to default condition based on Pipe Nominal Bore

External Power Supply: 12V-24V +/- 10% AC/DC at 7 watts

Electronics Enclosure: IP54

Input/Output Cable: 5m x 6 core for power in and data out

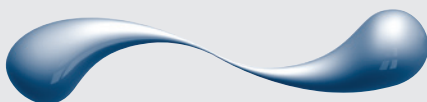

micronics
Through measurement comes control

U1000 - Permanent Ultrasonic Liquid Flow Meter



U1000 Flow Reading Screen

U1000 Product Features and Benefits

- Factory configured for pipe size – minimal site configuration
- Simplified guide rail & sensor assembly – simple installation
- Clamp-on – noninvasive & low install cost
- LCD with backlight – install & service information
- Integral pulse and 4-20mA outputs – aM&T & BEM's compatible

Simple steps for locating U1000 on pipe

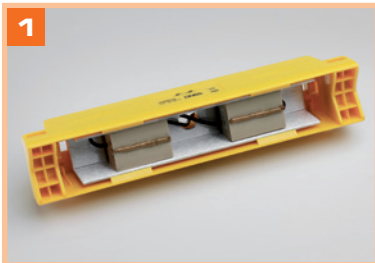

1 Guide rail and sensor assembly showing grease applied



2 Clamp guide rail and sensor assembly to pipe and release sensor locking screws



3 Connect power and sensors to electronic assembly



4 Click electronic assembly onto guide rail and sensor assembly

HOW DOES IT WORK?

The Ultraflo is a transit time ultrasonic flow meter designed to work with clamp-on transducers, to provide accurate measurement of liquid flowing within a closed pipe, without the need for any mechanical parts to be inserted through the pipe wall or to protrude into the flow system. It takes just a few minutes to install and there is no need to shut down flow or drain the system!

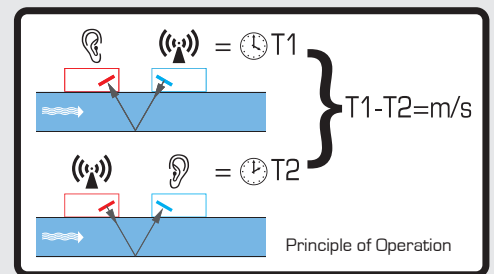

When ultrasound is transmitted between the transducers, the speed at which the sound travels through the liquid is accelerated slightly by the velocity of the liquid through the pipe. When ultrasound is transmitted in the opposite direction, the flow of the liquid causes the transmitted sound to decelerate. The subsequent time difference is directly proportional to the flow velocity in the pipe. Having measured the flow velocity and knowing the pipe cross-sectional area, the volumetric flow can be easily calculated.

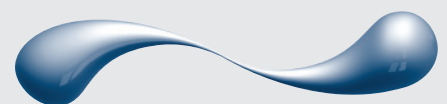



Power on configuration:

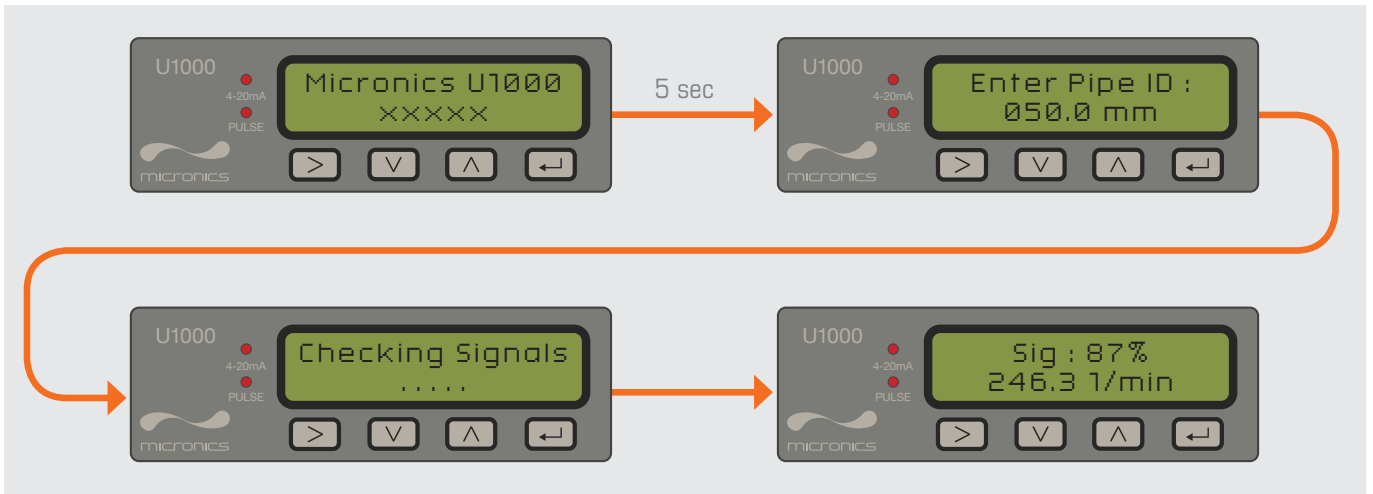

U1000 dimensions:

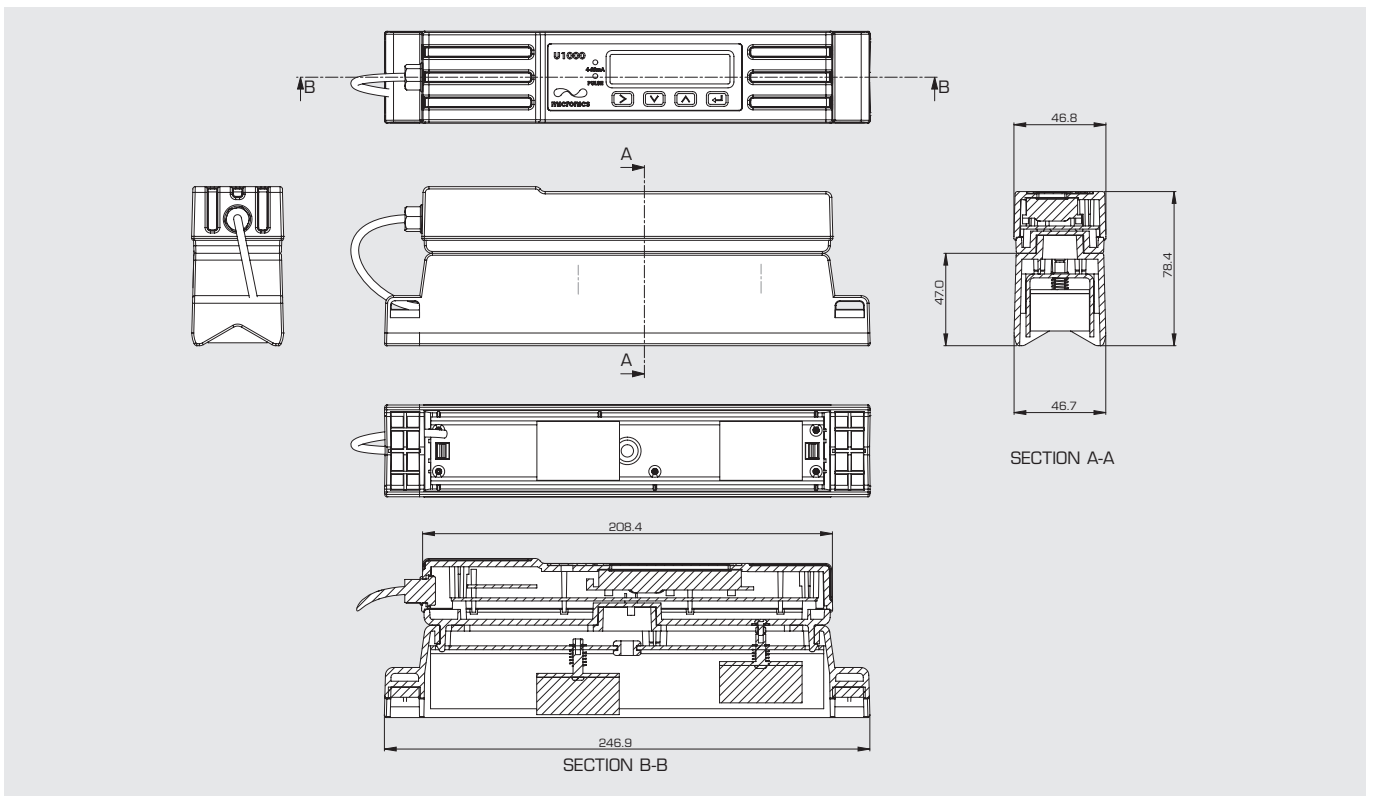

© Copyright 2012 Micronics Limited. Information subject to change without notice.

Micronics Ltd accepts no responsibility or liability if any product has not been installed in accordance with the installation instructions applicable to this product.

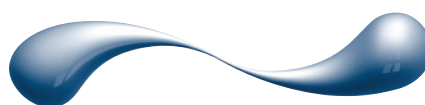

micronics
Through measurement comes control

Micronics Limited Knaves Beech Business Centre, Davies Way, Loudwater,
High Wycombe, Buckinghamshire, United Kingdom, HP10 9QR.

Telephone: +44 (0)1628 810456 **Facsimilie:** +44 (0)1628 531540 **E-mail:** sales@micronicsltd.co.uk

www.micronicsflowmeters.com