

Cube350 Installation Guide January 2010



1 Safety

This instruction sheet gives details of safe installation and operation of the **Cube350** electricity meter. Safety may be impaired if the instructions are not followed. Labels on each meter give details of equipment ratings for safe operation. Take time to examine all labels before commencing installation. Safety symbols on the meter have specific meanings.



Refer To User Manual

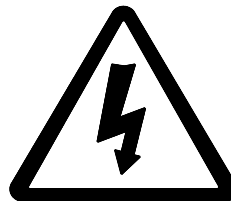

Risk of Electric Shock

WARNING

The meter contains no user serviceable parts.
Installation and commissioning should only be carried out by qualified personnel

Further information is available for download at <http://www.ndmeter.co.uk>.

2 Mounting In a Panel

Panels should be 1mm to 4mm thick with a square cutout of 92mm (+0.8/-0.0mm). Insert the meter from the front of the panel, slide the panel clips from the rear of the case and push firmly against the panel ensuring even pressure on each clip.

3 Standard Connections

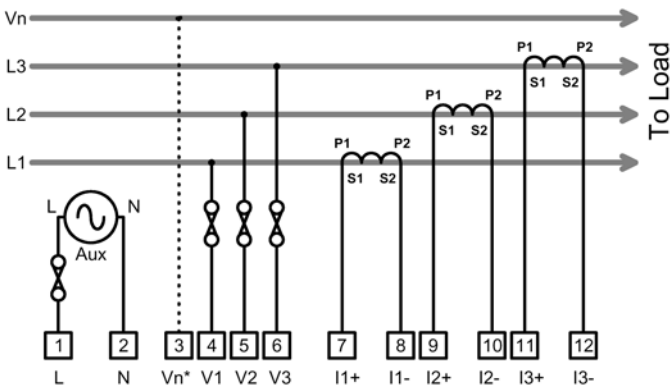

3-Phase 3 or 4-Wire (*Optional Neutral)

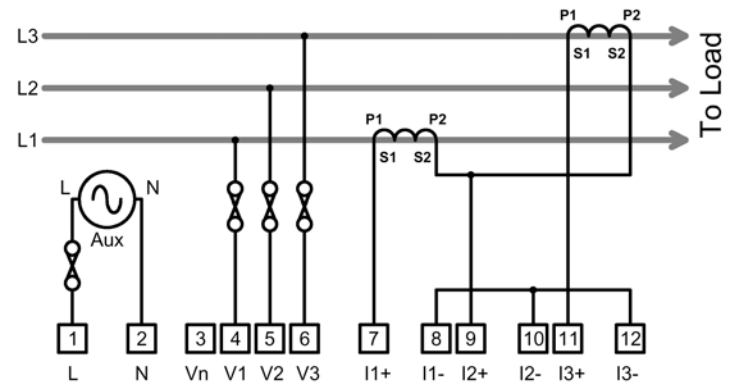

3-Phase 3-Wire (2 CTs)

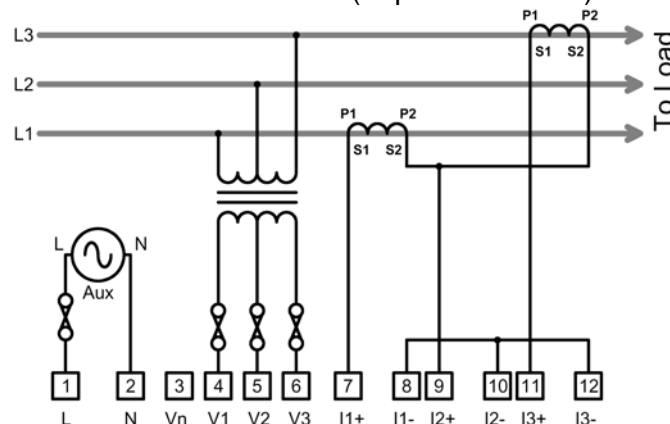

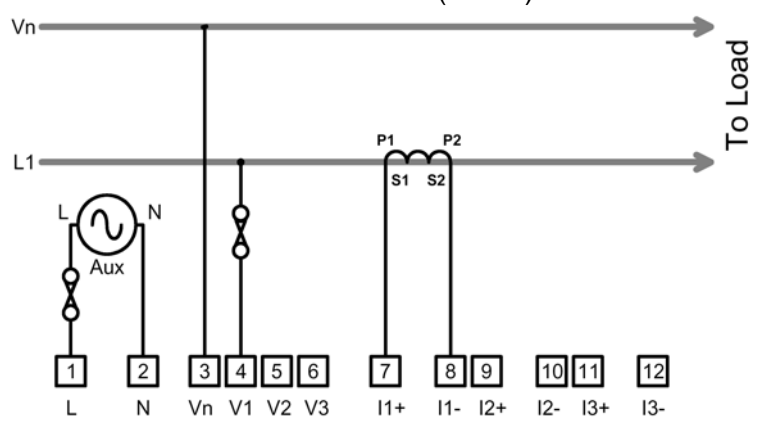

3-Phase High Voltage (HV)



Single Phase







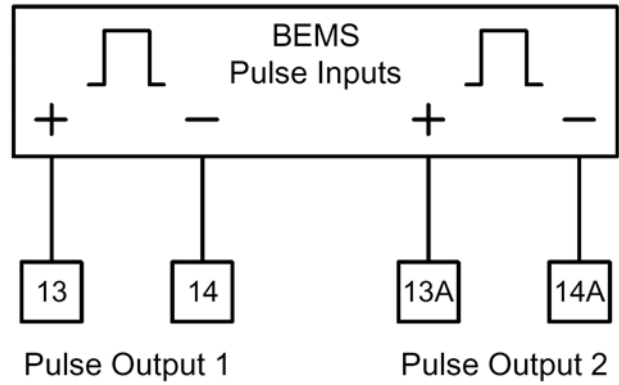

















3.1 Pulse Output Connections

The pulse outputs take the form of isolated volt free normally open contact pairs. Pulse 1 is associated with active energy (kWh) and Pulse 2 with reactive energy (kvarh). The contacts are isolated from all other circuits (2.5kV / 1 minute) and at 50V from pulse 1 to pulse 2. Pulses can be used as input to remote counters, pulse loggers, building energy management system etc.

Light emitting diodes  and  remain **ON** during each associated output pulse.





4 Display Menus

			
 Phase 1 RMS Amps	 Ph1-n RMS Voltage	 System kW	 System kWh ^{3,4}
 Phase 2 RMS Amps	 Ph2-n RMS Voltage	 System PF (c=capacitive)	 System kvarh ^{3,4}
 Phase 3 RMS Amps	 Ph3-n RMS Voltage	 Frequency	 Hours Run ^{2,3}
	 L1-L2 RMS Voltage	 Ph1 Real Power ¹	
	 L2-L3 RMS Voltage	 Ph2 Real Power ¹	
	 L3-L1 RMS Voltage	 Ph3 Real Power ¹	
		 Ph1 PF (c=capacitive) ¹	
		 Ph2 PF (c=capacitive) ¹	
		 Ph3 PF (c=capacitive) ¹	

Note 1: Display of some per phase values may be disabled before mounting in a panel.

Note 2: The Hours Run register accumulates the total time during which the average 3-phase load current exceeds a preset level. This is always displayed with a resolution of 0.1hour.

The percentage level of (I1+I2+I3) at which the Hours Run register accumulates is user programmable from 1% to 100% of full scale current.

Note 3: Press  and  together and hold for 2 seconds to reset the displayed value. This feature may be disabled before mounting in a panel.

Note 4: Scaling of the energy registers is set by the nominal input currents and voltages and remains constant during operation of the meter. Energy registers will each accumulate from zero to 99,999,999 then restart from zero.

4.1 Phase Healthy Indicators

Three LEDs indicate when the individual phase-neutral voltages are present. These will illuminate when the measured voltage is above 80% of the nominal value. Below this level the LEDs will be off.





Phase Healthy LEDs

4.2 Programming

To Enter Programming:

Press and hold  and  together until display shows CT.

To Change a Setting Value:

Press  or  until the required value is set.



To Move to The Next Setting:

Press  until the next page in the list is displayed. Parameters are set in the following order:

Fine Adjust Ct and Un Settings

CT Primary and Nominal Voltage settings are selected from a table of preferred values. This reduces the time to program these parameters to industry standard values.

Fine Adjust Mode allows values other than those provided by the default tables to be set. To enter/exit **Fine Adjust Mode**:

Hold  and  together for 2 Seconds while setting **CT** or **Un**.

Fine Adjust Mode is indicated by a decimal point immediately after the parameter type (ie. "CT." or "Un.")

Current Transformer Primary

Voltage Transformer Primary

Pulse Output Rate (1 and 2)

Pulse On Time (Seconds)

Pulse Test

Hours Run %Amps Trigger



Voltage Input Mode

CT Auto Rotation Mode

Store Setup to Memory

4.3 Pulse Output Test

This feature allows the pulse output hardware and external system connections to be commissioned without a measured load. The LCD shows **Pto** (off) and **Ptr** (run) and the number of test pulses. The test pulse rate is set automatically dependant on the programmed pulse length (maximum 0.5Hz).

Press  to start/stop the test pulses on both outputs.

Press  and  together to stop the test pulses and simultaneously reset the test counter.

5 Specification

INPUTS	
System	3 Phase 3 or 4 Wire Unbalanced Load
Voltage Un	400/230V. 3 Phase 3 or 4 Wire 110/63V & 208/120V optional. Others to order.
Current In	5A from external CTs. 1A optional. Fully isolated
Measurement	Voltage 50% to 120%
Range	Current 0.2% to 120%
Frequency Range	Fundamental 45 to 65Hz
	Harmonics Up to 30th harmonic at 50Hz Individual to the 15th
Burden	Voltage <0.1VA per phase
	Current <0.1VA per phase
Overload	Voltage x4 for 1 hour
	Current x40 for 0.5 second max
DISPLAY	
Type	Custom, Supertwist, LCD
Data Retention	10 years min. Stores kWh & Meter set-up
Format	8 x 6.66mm high digits with DPs & 3.2mm legends
Scaling	Direct reading. User programmable CT & VT
	CT Primary programmable from 5A to 25kA
	VT primary programmable from 11V to 55kV
Legends	Wh, kWh, MWh etc. depending on user settings
AUXILIARY SUPPLY	
Standard	230V 50/60 Hz $\pm 15\%$
Options	110V 50/60 Hz $\pm 15\%$
Load	2VA max.
Overload	x1.2 continuous
ACCURACY All errors ± 1 digit	
kWh	Better than Class 1 per EN 62053-21 & BS 8431
kvarh	Better than Class 2 per EN 62053-23 & BS 8431
kW & kVA	Better than Class 0.25 IEC 60688
kvar	Better than Class 0.5 IEC 60688
Amps & Volts	Class 0.1 IEC 60688 (0.01In – 1.2In or 0.1Un – 1.2Un)
PF	$\pm 0.2^\circ$ (0.05In – 1.2In and 0.2Un – 1.2Un)
Neutral Current	Class 0.5 IEC 60688 (0.05In – 1.2In)
PULSE OUTPUTS	
Function	1 Pulse per unit of energy
Scaling	Settable between 1 & 1000 counts of kWh register
Pulse Period	0.1 sec. default; Settable between 0.1 and 20 sec
Rise & Fall Time	< 2.0ms
Type	N/O Volt free contact. Optically isolated BiFET
Contacts	100mA ac/dc max., 100V ac/dc max, 0.5W Max Load
Isolation	2.5kV 50Hz 1 minute
MODBUS® Serial Comms	
Bus Type	RS485 2 wire + 0v. ½ Duplex, ¼ unit load
Protocol	MODBUS® RTU with 16 bit CRC
Baud Rate	4800, 9600 or 19,200 User settable
Address	1 – 247 User settable
Latency	Reply within 250ms max.
Command Rate	New command within 5ms of previous one
GENERAL	
Temperature	Operating -10°C to +65°C
	Storage -25°C to +70°C
Humidity	< 75% non-condensing
Environment	IP54 standard, IP65 optional
MECHANICAL	
Terminals	Rising Cage. 4mm ² (12 AWG) cable max.
Enclosure	DIN 43700 96 x 96
Material	Mablex® with fire protection to UL94-V-O. Self extinguishing
Dimensions	96 x 96 mm x 83.5 mm (72 mm behind panel)
Weight	~ 250 gms
SAFETY	
Conforms to	EN 61010-1 Installation Category III