



Acuvim II Series Power Meter User's Manual



ACCUENERGY

Copyright® 2015 V2.03

This manual may not be altered or reproduced in whole or in part by any means without the expressed written consent of Accuenergy.

The information contained in this document is believed to be accurate at the time of publication, however, Accuenergy assumes no responsibility for any errors which may appear here and reserves the right to make changes without notice. Please ask the local representative for latest product specifications before ordering.

[Document #1040E2203 Revision Date: Nov., 2015]

Please read this manual carefully before installation, operation and maintenance of Acuvim II series meter.

The following symbols in this manual and on Acuvim II series meters are used to provide warning of danger or risk during the installation and operation of the meters.



Electric Shock Symbol: Carries information about procedures which must be followed to reduce the risk of electric shock and danger to personal health.



Safety Alert Symbol: Carries information about circumstances which if not considered may result in injury or death.



UL US This mark indicates that this product is UL listed.

Installation and maintenance of the Acuvim II series meter should only be performed by qualified, competent professionals who have received training and should have experience with high voltage and current devices.

Accuenergy shall not be responsible or liable for any damages caused by improper meter installation and/or operation.

Content

Chapter 1 Introduction -----	1
1.1 Meter Overview-----	2
1.2 Areas of Application-----	4
1.3 Functionality-----	4
Chapter 2 Installation -----	9
2.1 Appearance and Dimensions-----	12
2.2 Installation Methods-----	14
2.3 Wiring-----	16
2.3.1 Terminal Strips-----	16
2.3.2 Power Requirement-----	17
2.3.3 Voltage Input Wiring-----	20
2.3.4 Current Input Wiring-----	22
2.3.5 Frequently Used Wiring Methods-----	24
2.3.6 Communication-----	28
Chapter 3 Meter Display and Parameter Settings -----	29
3.1 Display Panel and Keys-----	30
3.2 Metering Data-----	33
3.3 Statistics Data-----	40
3.4 Demand Data-----	42
3.5 Harmonic Data-----	42
3.6 Expanded I/O Module Data-----	45
3.7 Parameter Settings Mode-----	49
3.8 Page Recovery Function-----	65
Chapter 4 Detailed Functions and Software -----	67
4.1 Basic Analog Measurements-----	68
4.2 Max/Min-----	72
4.3 Harmonics and Power Quality Analysis-----	72

4.4 Over/Under Limit Alarming	73
4.5 Data Logging	81
4.6 Time of Use (TOU)	87
4.7 Power Quality Event Logging and Waveform Capture	93
4.8 Seal Function	104
Chapter 5 Extended Modules	111
5.1 IO Modules	112
5.2 Ethernet Module (AXM-NET)	141
5.3 ProfiBus Module (AXM-PROI)	181
5.4 RS485 Module (AXM-RS485)	199
5.5 BACnetModule(AXM-BACnet)	204
Chapter 6 Communication	231
6.1 Modbus Protocol Introduction	232
6.2 Communication Format	235
6.3 Data Address Table and Application Details	240
6.3.1 System Parameter Setting	242
6.3.2 System Status Parameter	245
6.3.3 Date and Time Table	247
6.3.4 Over/Under Limit Alarming Setting	247
6.3.5 I/O Modules Settings	250
6.3.6 100ms Refresh Metering Parameter	258
6.3.7 Metering Parameter Address Table	259
6.3.8 Data Logging	275
6.3.9 Time of Use TOU	284
6.4 DNP3.0 Protocol Introduction	314
Appedix	331
Appendix A Technical data and specifications	332
Appendix B Ordering Information	337
Appendix C Revision History	340

Starting!**Congratulations!**

You have purchased an advanced, versatile, multifunction power meter. This meter can work as a remote terminal unit (RTU) that contributes to your system's stability and reliability by providing real-time power quality monitoring and analysis.

When you open the package, you will find the following items

- | | |
|---|---|
| 1. Acuvim II series meter | 1 |
| 2. Terminal Blocks | 3 |
| 3. Installation clips | 4 |
| 4. Rubber Gasket | 1 |
| 5. Product Disk (Manual, Warranty, Software) | 1 |
| 6. Additional documentation(Quick Setup Guide, Calibration Certificate) | 2 |

To avoid complications, please read this manual carefully before installation and operation of the Acuvim II series meter.

Chapter 1 Introduction

Chapter 2 Installation and Wiring

Chapter 3 Meter Display and Parameter Settings

Chapter 4 Detailed Functions and Software

Chapter 5 Extended Modules

Chapter 6 Communication

Appendix Technical Data, Specifications and Ordering Information

Chapter 1 Introduction

1.1 Meter Overview

1.2 Areas of Application

1.3 Functionality

1.1 Meter Overview

Powerful Multifunction Power Meter

The Acuim II series multifunction digital power meter is designed using modern MCU and DSP technology. It integrates three-phase energy measuring and displaying, energy accumulating, power quality analysis, malfunction alarming, data logging and network communication. A vivid LCD display with large characters and, time of use programmable backlight provides a clear real-time data readout.

An Ideal for Electric Automation SCADA Systems

The Acuim II series meter is the ideal choice for replacing traditional, analog electric meters. In addition to providing clear real-time readings on the meter front, it can also be used as a remote terminal unit (RTU) for monitoring and controlling for a SCADA system. Users can access all measurement parameters via the standard RS485 communication port (or the optional Ethernet port) with the Modbus™ protocol.

Energy Management

The Acuim II series meter is able to measure bidirectional, four quadrants kWh and kvarh. It provides maximum/minimum records for power usage and power demand parameters. All power and energy parameters can be viewed remotely via software in order to easily monitor various parameters. In addition, measurement tables can be viewed from the free Acuvue software.

Remote Power Control

This meter is designed for measuring and monitoring power quality parameters. Since different I/O modules can be added to the meter, this expands the capabilities and provides a very flexible platform for using the meter as a distributed RTU, for metering, monitoring and remote controlling, all in one unit.

Power Quality Analysis

Utilizing digital signal processing (DSP) technology, the Acuvim II series meter provides high accuracy power quality analysis and supports remote monitoring via the Ethernet module. The meter continuously updates metering results and allows users to access the meter online to monitor parameters such as voltage and current THD, harmonics, voltage crest factor, current K factor, and voltage and current unbalance factor etc.

Data Logging

The Acuvim IIR/IIE/IIW meter contains 8 megabytes of onboard memory for data logging and historical trending. Since the meter contains a real-time clock, all events and logged data will be time stamped.

Time of use (TOU-Acuvim IIE)

User can assign up to 4 different tariffs (sharp, peak, valley and normal) to different time period within a day according to the billing requirements. The meter will calculate and accumulate energy to different tariffs according to the meter's internal clock timing and TOU settings.

Power Quality Event Logging

When a power quality event happens, such as voltage sag and swell, etc, Acuvim IIW will record the timestamp and the triggering condition of the event. It can save up to 50,000 power quality events.

Waveform Capture

Acuvim IIW contains another 8 megabytes of on board memory for power quality event logging and waveform capture. Acuvim IIW can record 100 groups of voltage and current waveforms. It logs at 64 points per cycle. It provides the waveform record of 10 cycles before and after the triggering point. It also supports a settable triggering condition.

1.2 Areas of Application

- Power Distribution Automation
- Industry Automation
- Energy Management Systems
- Renewable Energy
- Electric Switch Gear and Control Panels
- Building Automation
- Marine Applications

1.3 Functionality

Multifunction

Acuvim II meters provide powerful data collecting and processing functions. In addition to measuring various parameters, the meter is able to perform demand metering, harmonic analysis, max/min statistic recording, over/under limit alarming, energy accumulating and data logging.

High Accuracy

Accuracy of Voltage and Current is 0.2%, True-RMS.

Accuracy of Power and Energy is 0.2%, while monitoring all four quadrants.

Compact and Easy to Install

This meter can be installed into a standard ANSI C39.1 (4" Round) or an IEC 92mm DIN (Square) cut out. With the 51mm depth after mounting, the Acuvim II series meter can be installed in a small cabinet. Mounting clips are used for easy installation and removal.

Easy to Use

All metering data and setting parameters can be accessed by using the front panel keys or via the communication port. Setting parameters are stored in the EEPROM so that content will be preserved when the meter is powered off.

Multiple Wiring Modes

The Acuvim II series meter can be used in high voltage, low voltage, three phase three wires, three phase four wires and single phase systems using different wiring mode settings.

High Safety, High Reliability

Acuvim II series meter was designed according to industrial standards. It can run reliably under high power disturbance conditions. This meter has been fully tested for EMC and safety compliance in accordance with UL and IEC standards.

Function Comparison of Acuvim II series Meters

Category		Item	Parameters	Acuvim II	Acuvim IIR	Acuvim IIE	Acuvim IIW
Metering	Real Time Metering	Phase Voltage	V1, V2, V3, Vlnavg	●	●	●	●
		Line Voltage	V12, V23, V31, Vllavg	●	●	●	●
		Current	I1, I2, I3, In, Iavg	●	●	●	●
		Power	P1, P2, P3, Psum	●	●	●	●
		Reactive Power	Q1, Q2, Q3, Qsum	●	●	●	●
		Apparent Power	S1, S2, S3, Ssum	●	●	●	●
		Power Factor	PF1, PF2, PF3, PF	●	●	●	●
		Frequency	F	●	●	●	●
		Load Features	Load Features	●	●	●	●
	Four Quadrant Powers	Four Quadrant Powers	●	●	●	●	
	Energy & Demand	Energy	Ep_imp, Ep_exp, Ep_total, Ep_net Epa_imp; Epa_exp; Epb_imp; Epb_exp; Epc_imp; Epc_exp	●	●	●	●
		Reactive Energy	Eq_imp, Eq_exp, Eq_total, Eq_net Eqa_imp; Eqa_exp; Eqb_imp; Eqb_exp; Eqc_imp; Eqc_exp	●	●	●	●
		Apparent Energy	Es; Esa; Esb; Esc	●	●	●	●
		Demand	Dmd_p, Dmd_Q, Dmd_S, Dmd_I1, Dmd_I2, Dmd_I3	●	●	●	●
TOU	Time Of Use	Energy/max demand	TOU, 4 Tariffs, 12 Seasons, 14 Schedules		●		
	Daylight Saving Time	Two formats adjjust	Month/Day/Hour/Minute; Month/Week/First few weeks/Hour/Minute		●		

Category		Item	Parameters	Acuvim II	Acuvim IIR	Acuvim IIE	Acuvim IIW
Monitoring	Waveform Capture If 400Hz type, there is no this function	voltage and current Waveform	Trigger, Manual, DI change, Sag/Dips, Swell, Over Current				●
	Power Quality	Voltage Unbalance Factor	U_unbl	●	●	●	●
		Current Unbalance Factor	I_unbl	●	●	●	●
		Voltage THD	THD_V1, THD_V2, THD_V3, THD_Vavg	●	●	●	●
		Current THD	THD_I1, THD_I2, THD_I3, THD_Iavg	●	●	●	●
		Individual Harmonics	Harmonics 2 nd to 63 rd If 400Hz, Harmonics 2 nd to 15 th	●	●	●	●
		Voltage Crest Factor	Crest Factor	●	●	●	●
		TIF	THFF	●	●	●	●
	Current K factor	K Factor	●	●	●	●	
	Statistics	MAX with Time Stamp MIN with Time Stamp	Each phase of V & I; Total of P, Q, S, PF & Demand of P, Q & S; Each phase THD of V & I; Unbalance factor of V & I	●	●	●	●
Others	Alarm	Over/Under Limit Alarm	V, I, P, Q, S, PF, V_THD & I_THD each phase and total or average; Unbalance factor of V & I; load type; Analog Input of each channel	●	●	●	●
	Power Quality Event Logging If 400Hz type, there is no this function	SAG/DIPS, SWELL	Voltage				●
	Data Logging	Data Logging 1 Data Logging 2 Data Logging 3	F, V1/2/3/Inavg, V12/23/13/Inavg, I1/2/3/n/avg, P1/2/3/sum, Q1/2/3/sum, S1/2/3/sum, PF1/2/3, PF, U_unbl, I_unbl, Load Type, Ep_imp, Ep_exp, Ep_total, Ep_net, Eq_imp, Eq_exp, Eq_total, Eq_net, Es, THD_V1/2/3/avg, THD_I1/2/3/avg, Harmonics 2 nd to 63 rd , Crest Factor, THFF, K Factor, sequence and phase angles, DI counter, AI, AO, Dmd P/Q/S, Dmd I1/2/3/Ep_imp; Ep_exp; Epb_imp; Epb_exp; Epc_imp; Epc_exp; Eq_imp; Eq_exp; Eqb_imp; Eqb_exp; Eqc_imp; Eqc_exp; Esa; Esb; Esc		●	●	●
	Onboard Memory Size	Memory	Bytes	—	8MB	8MB	16MB

Category		Item	Parameters	Acuim II	Acuim IIR	Acuim IIE	Acuim IIW
Others	Communication	RS485 Port, Half Duplex, Optical Isolated	Modbus-RTU/DNP3.0 Protocol	●	●	●	●
	Time	Real Time Clock	Year, Month, Date, Hour, Minute, Second	●	●	●	●
	400Hz type		Only support full-wave energy, support 2 nd ~ 15 th individual harmonics.	●	●	●	
Option Module	I/O Option	Switch Status (DI)	Digital Input (Wet)	⊙	⊙	⊙	⊙
		Power Supply for DI	24 Vdc	⊙	⊙	⊙	⊙
		Relay Output (RO)	NO, Form A	⊙	⊙	⊙	⊙
		Digital Output (DO)	Photo-MOS	⊙	⊙	⊙	⊙
		Pulse Output (PO)	By using DO	⊙	⊙	⊙	⊙
		Analog Input (AI)	0(4)~20mA, 0(1)~5V	⊙	⊙	⊙	⊙
	Analog Output (AO)	0(4)~20mA, 0(1)~5V	⊙	⊙	⊙	⊙	
	Communication	Ethernet	Modbus-TCP, HTTP, SNMP, SMTP, Sntp	⊙	⊙	⊙	⊙
		Profibus-DP	Profibus-DP/V0	⊙	⊙	⊙	⊙
		The second way RS485 Module	Modbus-RTU Protocol	⊙	⊙	⊙	⊙
BACnet		IP or MS/TP	⊙	⊙	⊙	⊙	

● Function; ⊙ Option; Blank NA

Chapter 2 Installation

2.1 Appearance and Dimensions

2.2 Installation Methods

2.3 Wiring

2.3.1 Terminal Strips

2.3.2 Power Requirements

2.3.3 Voltage Input Wiring

2.3.4 Current Input Wiring

2.3.5 Frequently Used Wiring Methods

2.3.6 Communication

Considerations When Installing Meters



- Installation of the meter must be performed by qualified personnel only, who follow standard safety precautions through the installation procedures. Those personnel should have appropriate training and experience with high voltage devices. Appropriate safety gloves, safety glasses and protective clothing are recommended.
- During normal operation, dangerous voltage may flow through many parts of the meter, including terminals, and any connected CTs (Current Transformers) and PTs (Potential Transformers), all I/O (Inputs and Outputs) modules and their circuits. All primary and secondary circuits can, at times, produce lethal voltages and currents. AVOID contact with any current-carrying surfaces.
- The meter and its I/O output channels are NOT designed as primary protection devices and shall NOT be used as primary circuit protection or in an energy-limiting capacity. The meter and its I/O output channels can only be used as secondary protection. AVOID using the meter under situations where failure of the meter may cause injury or death. AVOID using the meter for any application where risk of fire may occur.
- All meter terminals should be inaccessible after installation.
- Do NOT perform Dielectric (HIPOT) test to any inputs, outputs or communication terminals. High voltage testing may damage electronic components of the meter.
- Applying more than the maximum voltage the meter and/or its modules can withstand will permanently damage the meter and/or its modules. Please refer to the specifications for all devices before applying voltages.

- When removing meter for service, use shorting blocks and fuses for voltage leads and power supply to prevent hazardous voltage conditions or damage to CTs. CT grounding is optional.
- ACCUENERGY recommends using a dry cloth to wipe the meter.



NOTE: IF THE EQUIPMENT IS USED IN A MANNER NOT SPECIFIED BY THE MANUFACTURER, THE PROTECTION PROVIDED BY THE EQUIPMENT MAY BE IMPAIRED.



NOTE: THERE IS NO REQUIRED PREVENTIVE MAINTENANCE OR INSPECTION NECESSARY FOR SAFETY. HOWEVER, ANY REPAIR OR MAINTENANCE SHOULD BE PERFORMED BY THE FACTORY.

DISCONNECT DEVICE: The following part is considered the equipment disconnect device.

A SWITCH OR CIRCUIT-BREAKER SHALL BE INCLUDED IN THE INSTALLATION. THE SWITCH SHALL BE IN CLOSE PROXIMITY TO THE EQUIPMENT AND WITHIN EASY REACH OF THE OPERATOR. THE SWITCH SHALL BE MARKED AS THE DISCONNECTING DEVICE FOR THE EQUIPMENT.

The installation method is introduced in this chapter. Please read this chapter carefully before beginning installation.

2.1 Appearance and Dimensions

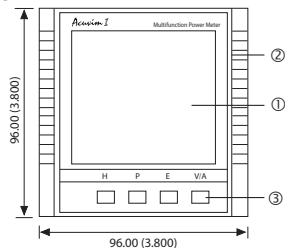

Front View of the Display Meter and Remote Display Unit

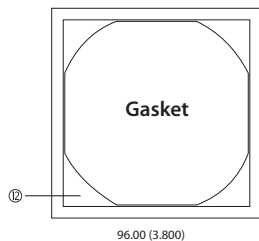

Gasket

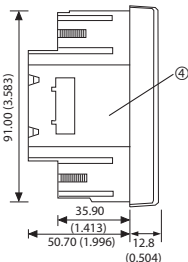

Side View of the Display Meter

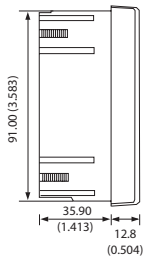

Side View of the Remote Display Unit

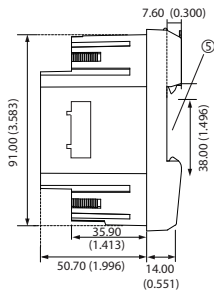

Side View of the DIN rail Meter

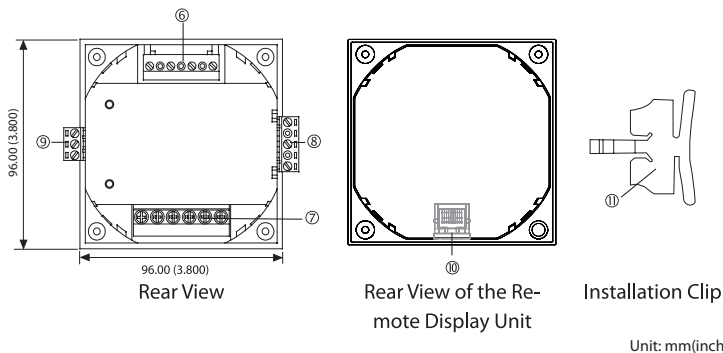

Fig 2-1 Appearance and dimensions of Acuvim II series meter

Table 2-1 Part name of Acuvim II series meter

Part Name	Description
① LCD Display	Large bright white backlight LCD display.
② Front Casing	Visible portion (for display and control) after mounting onto a panel.
③ Key	Four keys are used to select display and set.
④ Enclosure	The Acuvim II series meter enclosures is made of high strength anti-combustible engineering plastic.
⑤ DIN rail	Used for Installation 35mm rail of the DIN rail Meter.
⑥ Voltage Input Terminals	Used for voltage input.
⑦ Current Input Terminals	Used for current input.
⑧ Power Supply Terminals	Used for control power input
⑨ Communication Terminals	Communication output.
⑩ Interface	Used for link the remote display unit and the DIN rail meter.
⑪ Installation Clip	Used for fixing the meter to the panel.
⑫ Gasket	Insert the gasket in between the meter and the cutout to cover up gaps from the round hole.

2.2 Installation Methods

Environmental

Before installation, please check the environment, temperature and humidity to ensure the AcuVim II series meter is being placed where optimum performance will occur.

Temperature

Operation: -25°C to 70°C .

Storage: -40°C to 85°C

Humidity

5% to 95% non-condensing.

The AcuVim II series meter should be installed in a dry and dust free environment. Avoid exposing meter to excessive heat, radiation and high electrical noise source.

Installation Steps

The AcuVim II series meter can be installed into a standard ANSI C39.1 (4" Round) or an IEC 92mm DIN (Square) form.

1. Cut a square hole or round hole on the panel of the switch gear.
The cutting size is shown in fig 2-2.

Unit: mm (inches)

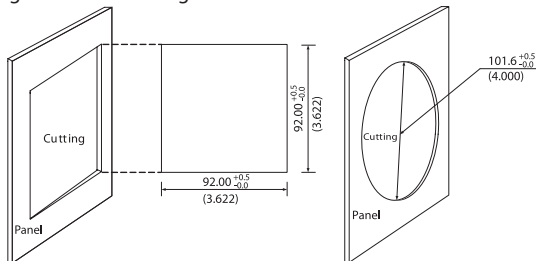

Fig 2-2 Panel Cutout

2. Remove the clips from the meter, and insert the meter into the square hole from the front side. Please note: optional rubber gasket must be installed on the meter before inserting the meter into the cut out.

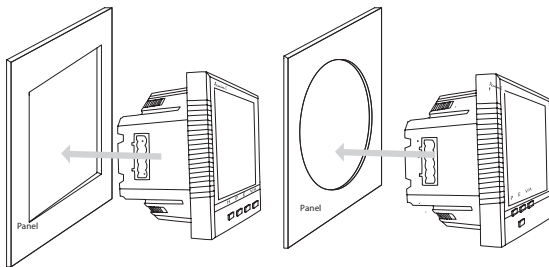

Fig 2-3 Put the meter into the opening

3. Install clips on the back side of the meter and secure tightly to ensure the meter is affixed to the panel.

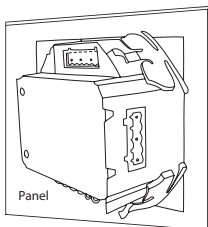

Fig 2-4 Use the clips to fix the meter on the panel

Note: The display meter and the remote display unit have the same installation method. The DIN rail meter is simply installed on a 35mm DIN rail.

2.3 Wiring

2.3.1 Terminal Strips

There are four terminal strips at the back of the Acuvim II series meter. The three phase voltage and current are represented by using 1, 2, and 3 respectively. These numbers have the same meaning as A, B, and C or R, S, and T used in other literature.

Current Input Terminal Strip

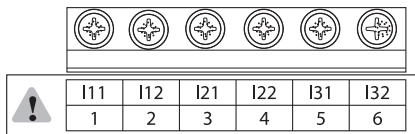

Voltage Input Terminal Strip

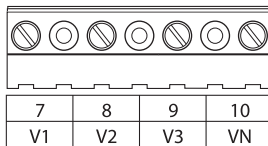

Power Supply Terminal Strip

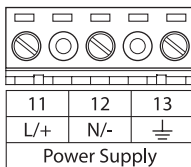

Communication Terminal Strip

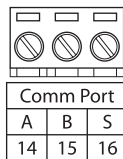

Fig 2-5 Terminal Strips of Acuvim II series meter

**DANGER**

Only the qualified personnel does do the wire connection work. Make sure the power supply is cut off and all the wires are powerless. Failure to observe it may result in severe injury or death.

Safety Earth Connection

Before setting up the meter's wiring, please make sure that the switch gear has an earth ground terminal. Connect both the meter's and the switch gear's ground terminal together. The following ground terminal symbol is used in this user's manual.



Fig 2-6 Safety Earth Symbol

**NOTE**

Make sure the control power terminal of the meter ground is connected to the safety Earth of switchgear.

2.3.2 Power Requirement**Control Power**

There are 2 options for the Control Power of the Acuvim II series meter:

1. Standard: 100~415Vac (50/60Hz) or 100-300Vdc
2. Low Voltage DC Option: 20-60Vdc

The 2 options must be chosen according to the application. Please see the ordering information appendix for further details.

**NOTE**

Make sure the voltage of power supply is the same as what the meter needed for its control power.

The meter's typical power consumption is very low and can be supplied by an independent source or by the measured load line. A regulator or an uninterrupted power supply (UPS) should be used under high power fluctuation conditions. Terminals for the control power supply are 11, 12 and 13 (L, N, and Ground). A switch or circuit-breaker shall be included in a building installation. It shall be in close

proximity to the equipment, within easy reach of the operator, and shall be marked as the disconnecting device for the equipment.

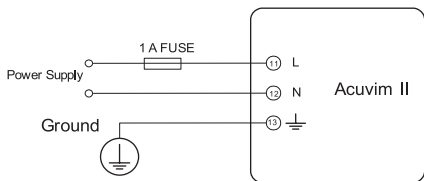

Fig 2-7 Power supply

A fuse (typical 1A/250Vac) should be used in the auxillary power supply loop. No.13 terminal must be connected to the ground terminal of the switchgear. An isolated transformer or EMC filter should be used in the control power supply loop if there is a power quality problem in the power supply.

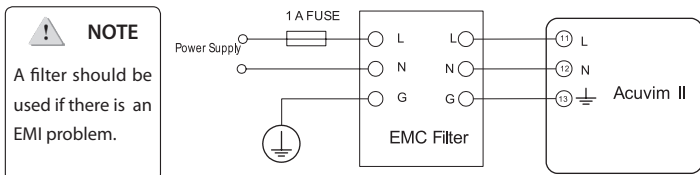

Fig 2-8 Power supply With EMC filter

Choice of wire of power supply is AWG22-16 or 0.6-1.5mm².

Voltage Input

Maximum input voltage for the AcuVim II series meter shall not exceed 400LN/690LL VAC rms for three phase or 400LN VAC rms for single phase.

Potential Transformer (PT) must be used for high voltage systems. Typical secondary output for PTs shall be 100V or 120V. Please make sure to select an

appropriate PT to maintain the measurement accuracy of the meter. When connecting using the star configuration wiring method, the PT's primary side rated voltage should be equal to or close to the phase voltage of the system to utilize the full range of the PT. When connecting using the delta configuration wiring method, the PT's primary side rated voltage should be equal to or close to the line voltage of the system. A fuse (typical 1A/250Vac) should be used in the voltage input loop. The wire for voltage input is AWG16-12 or 1.3-2.0mm².

Note: In no circumstance should the secondary of the PT be shorted. The secondary of the PT should be grounded at one end. Please refer to the wiring diagram section for further details.

Current Input

Current Transformers (CTs) are required in most engineering applications. Typical current rating for the secondary side of the CT shall be 5A (standard) or 1A (Optional), please refer to the ordering information appendix for further details. CTs must be used if the system rated current is over 5A. The accuracy of the CT should be better than 0.5% with rating over 3VA is recommended in order to preserve the meter's accuracy. The wire between CTs and the meter shall be as short as possible. The length of the wire have an effect on the accuracy.

The wire size of current PT input is AWG15-10 or 1.5-2.5mm².

Note: The secondary side of the CT should not be open circuit in any circumstance when the power is on. There should not be any fuse or switch in the CT loop. One end of the CT loop should be connected to the ground.

Vn Connection

Vn is the reference point of the Acuvim II series meter voltage input. Low wire resistance helps improve the measurement accuracy. Different system wiring

modes require different Vn connection methods. Please refer to the wiring diagram section for more details.

Three Phase Wiring Diagram

This meter can satisfy almost any kind of three phase wiring diagrams. Please read this section carefully before choosing the suitable wiring method for your power system.

Voltage and current input wiring mode can be set separately in the meter parameter setting process. The voltage wiring mode can be set as 3-phase 4-line Wye (3LN), 3-phase 3-line direct connection(3LL), 3-phase 3-line open delta(2LL), single phase 2-line(1LN) and single phase 3-line(1LL) . The current input wiring mode can be set as 3CT, 2CT and 1CT. The voltage mode can be grouped with the current mode as 3LN-3CT (3CT or 2CT, 3LL-3CT, 2LL-3CT, 2LL-2CT, 1LL-2CT, 1LN-1CT).

2.3.3 Voltage Input Wiring

3-Phase 4-Line Wye Mode (3LN)

The 3-Phase 4-Line wye mode is commonly used in low voltage electric distribution power systems. For voltage lower than 400LN/690LL Vac, power line can be connected directly to the meter's voltage input terminal as shown in Fig 2-9a. For high voltage systems (over 400LN/690LL Vac), PTs are required as shown in Fig 2-9b. The meter should be set to 3LN for both voltage levels.

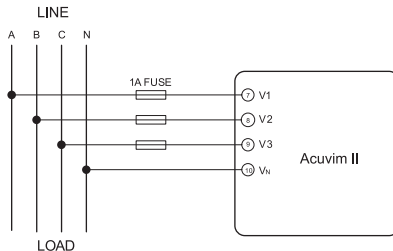

Fig 2-9a 3LN direct connection

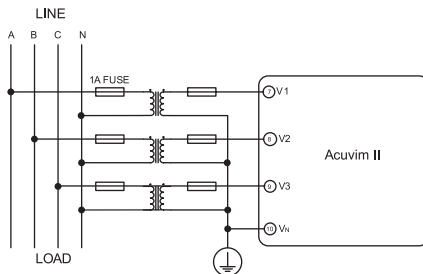

Fig 2-9b 3LN with 3PT

3-Phase 3-Line Direct Connection Mode (3LL)

In a 3-Phase 3-Line system, power line A, B and C are connected to V1, V2 and V3 directly. Vn is floated. The voltage input mode of the meter should be set to 3LL.

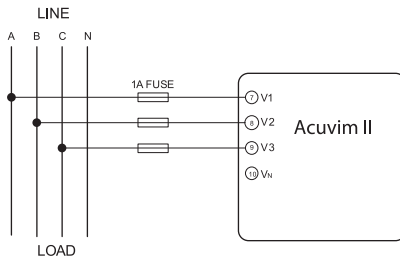

Fig 2-10 3LL 3-Phase 3-Line direct connection

3-Phase 3-Line open Delta Mode (2LL)

Open delta wiring mode is often used in high voltage systems. V2 and Vn are connected together in this mode. The voltage input mode of the meter should be set to 2LL for this voltage input wiring mode.

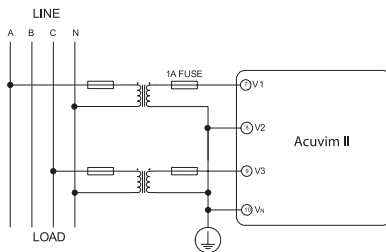

Fig 2-11 2LL with 2PTS

2.3.4 Current Input Wiring

3CT

The 3CT current wiring configuration can be used when either 3CTs are connected (as shown in Fig 2-12) or 2CTs are connected (as shown in Fig 2-13)

to the system. In either case, there is current flowing through all three current terminals.

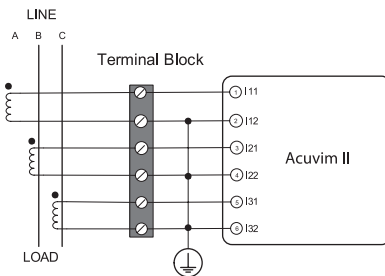

Fig 2-12 3CTs a

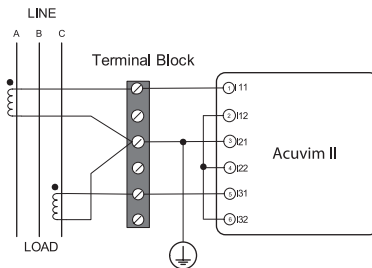

Fig 2-13 3CTs b

2CT

The difference between Fig 2-14 and Fig 2-15 is that no current flows through current input terminal I21 and I22. The meter should be set to the I2 value which is calculated from formula $i_1 + i_2 + i_3 = 0$. The current input mode of the meter should be set to 2CT.

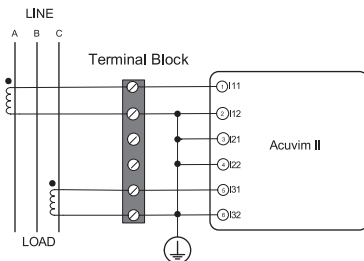

Fig 2-14 2CTs

1CT

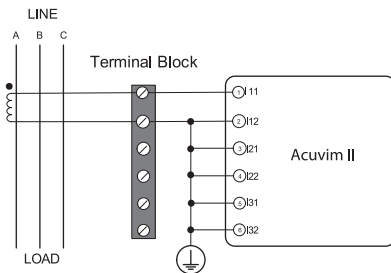

Fig 2-15 1CT

2.3.5 Frequently Used Wiring Method

In this section, the most common voltage and current wiring combinations are shown in different diagrams. In order to display measurement readings correctly, please select the appropriate wiring diagram according your setup and application.

1. 3LN, 3CT with 3CTs

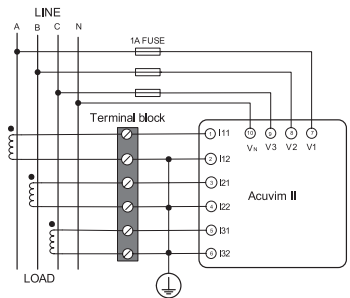

Fig 2-16 3LN, 3CT

2. 3LN, 3CT with 2CTs

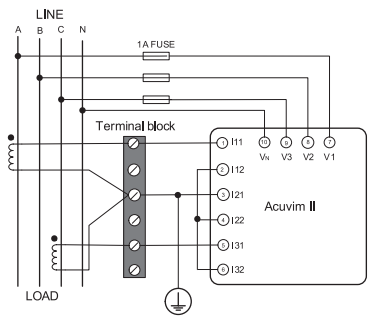

Fig 2-17 3LN, 3CT with 2CTs

3. 2LL, 3CT

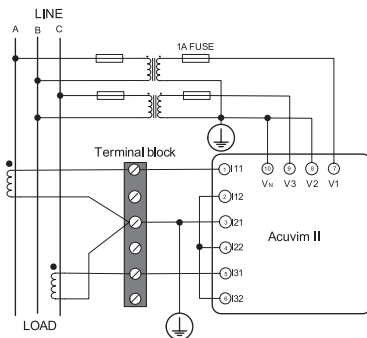

Fig 2-18 2LL, 3CT

4. 2LL, 2CT

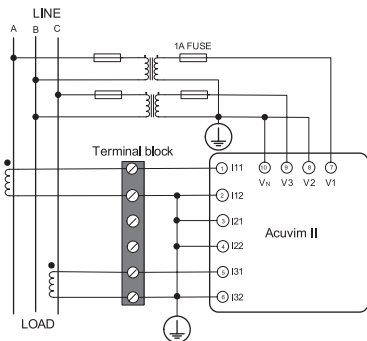

Fig 2-19 2LL, 2CT

5. 1LN, 1CT(Wiring mode setting 1LN, 1CT)

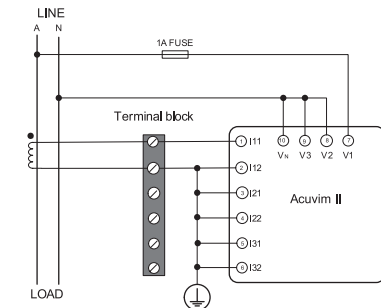

Fig 2-20 Single phase 2 Lines

6. 1LL, 2CT(Wiring mode setting 1LL, 2CT)

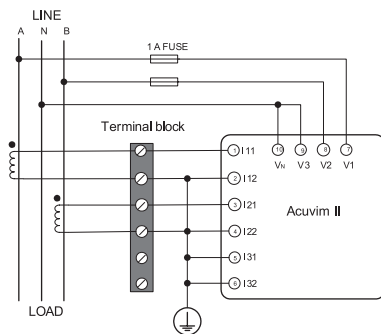

Fig 2-21 Single phase 3 Lines

2.3.6 Communication

Acuvim II series meter uses RS485 serial communication and the Modbus-RTU protocol. The terminals of communication are A, B, and S (14, 15, 16). A is differential signal +, B is differential signal - and S is connected to the shield of the twisted pair cables. Up to 32 devices can be connected on a RS485 bus. Use good quality shielded twisted pair cable, AWG22 (0.5mm²) or higher. The overall length of the RS485 cable connecting all devices should not exceed 1200m (4000ft). The Acuvim II series meter is used as a slave device of masters such as a PC, PLC, Data Collector or RTU.

If the master does not have RS485 communication port, a converter (such as a RS232/RS485 or a USB/RS485 converter) will be required. Typical RS485 network topologies include line, circle and star (wye). The shield of each segment of the RS485 cable must be connected to the ground at one end only.

Every A(+) should be connected to A(+), B(-) to B(-), or it will influence the network, or even damage the communication interface.

The connection topology should avoid "T" type which means there is a new branch and it does not begin from the beginning point.

Keep communication cables away from sources of electrical noise whenever possible.

When using a long communication cable to connect several devices, an anti signal reflecting resistor (typical value 120Ω-300Ω/0.25W) is normally added to the end of the cable beside the last meter if the communication quality is distorted.

Use RS232/RS485 or USB/RS485 converter with optical isolated output and surge protection.

Chapter 3 Meter Display and Parameter Settings

3.1 Display Panel and Keys

3.2 Metering Data

3.3 Statistics Data

3.4 Demand Data

3.5 Harmonic Data

3.6 Expanded I/O Module Data

3.7 Parameter Settings Mode

3.8 Page Recovery Function

Detailed human-machine interface of the meter will be described in this chapter. This includes viewing real-time metering data and setting parameters using different key combination.

3.1 Display Panel and Keys

The front of the Acuvim II series meter consists of an LCD screen and four control keys. All the display segments are illustrated in Fig 3-1. Users should note that all the segments will not display in a single page under normal conditions.

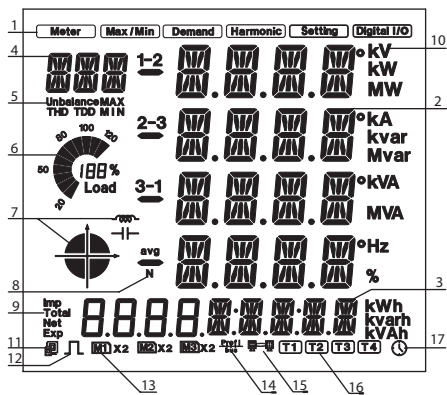



















Fig 3-1 All Display Segments

SN	Display	Description
1	Display mode indication	Shows different modes on the display area. "Meter" for real-time measurement; "Max/Min" for statistic data; "Demand" for power demand data; "Harmonic" for harmonic data; "Setting" for parameters setting; "Digital I/O" for expanded IO module data.
2	Four lines of  digits in the metering area	Main display area: displays metering data such as voltage, current, power, power factor, frequency, unbalance, phase angle, etc. Displays statistics such as maximum and minimum, demand data, display settings and expanded I/O data.
3	Four  and five  digits	Displays energy data and real-time clock. Also used for the setting mode and digital I/O mode display.
4	Three  digits	Item Icons: "U" for voltage; "I" for current; "P" for active power; "Q" for reactive power; "S" for apparent power; "PF" for power factor; "F" for frequency; "∠" for phase angles; "DMD" for demand; "Mxx" for expanded IO module type; and display setting page number.
5	Unbalance, THD, TDD, MAX, MIN	Item Icons: "Unbalance" for unbalance of the voltage and current; "THD" for total harmonics distortion; "TDD" for total demand distortion; "MAX" for maximum and "MIN" for minimum
6	Load rate 	Displays the percentage of load current to the nominal current.
7	Four quadrant icon  Load type icon  	 : quadrant of the system power  : inductive load;  : capacitive load
8	1-2, 2-3, 3-1, avg, N	1, 2, 3 for 3 phase A, B, C; 1-2, 2-3, 3-1 for 3 phase line-to-line AB, BC, CA; avg for average and N for neutral.
9	Energy icon: Imp, Total, Net, Exp	Imp: import energy Exp: export energy Total: absolute sum of Imp and Exp energy Net: algebraic sum of Imp and Exp energy

SN	Display	Description
10	Units measured	voltage: V, kV; current: A, kA; active power: kW, MW; reactive power: kvar, Mvar; apparent power: kVA, MVA; frequency: Hz; active energy: kWh; reactive energy: kvarh; apparent energy: kVAh; percentage: %; phase angle: °
11	Communication icon 	No icon: no communication One icon: query sent Two icons: query sent and response received
12	Energy pulse output indicator 	No icon: no pulse output With icon: icon blinks when sending pulse output
13	Expanded I/O module indicator 	M1: one AXM-IO1 connected M1x2: two AXM-IO1 connected None: no AXM-IO1 connected M2: one AXM-IO2 connected M2x2: two AXM-IO2 connected None: no AXM-IO2 connected M3: one AXM-IO3 connected M3x2: two AXM-IO3 connected None: no AXM-IO3 connected
14	Profibus module indicator 	No icon: Profibus module not connected With icon: Profibus module connected
15	Ethernet module indicator 	No icon: Ethernet module not connected With icon: Ethernet module connected, when the Second Communication Protocol is setting as Others BACnet module connected, when the Second Communication Protocol is setting as BACnet Mesh module connected, when the second communication Protocol is setting as Mesh.
16		Current tariff
17	Time icon 	Time display

There are four keys on the front panel, labeled H, P, E and V/A from left to right. Use these four keys to read real-time metering data, set parameters and

navigate the meter.

Note: If the LCD backlight is off, pressing any key one time will bring the backlight on.

3.2 Metering Data

Pressing H and V/A simultaneously will activate the display mode selection and the cursor will flash. Press P or E to move the cursor right or left. To enter the metering mode, move the cursor to "Meter" then press V/A.

In the metering mode, press P and E simultaneously will enter the TOU mode.

In metering mode, the meter displays measurements such as voltage, current, power, power factor, phase angle, unbalance etc.

In the TOU mode, meter displays the energy, maximum demand and it's time in different tariffs.

a) Voltage and Current:

Press V/A to read voltage and current in the metering area. The screen will roll to the next page when V/A is pressed again. It will go back to the first screen if you press V/A at the last screen. The following figure shows the sequence:

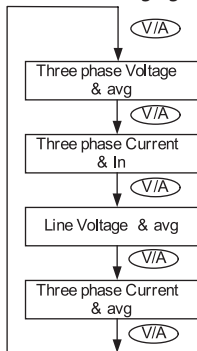

Note: When the meter is set to “2LL” or “3LL”, there is no phase voltage or neutral current display. Therefore, only the third screen (line voltage & avg) and the fourth screen (three phase current & avg) will be displayed.

When the meter is set to “1LN”, there are only phase A voltage and phase A current display, without line voltages or other displays.

When the meter is set to “1LL”, there are no phase C voltage and phase C current display.

b) Power, Power Factor and Frequency:

Press P to display power related data.

The screen will roll to the next page when P is pressed again. It will go back to the first screen if you press P at the last screen.

The following figure shows the sequence:

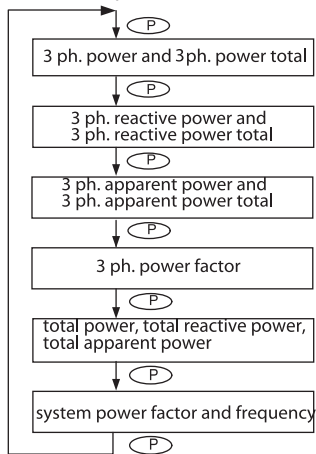

Note: When the meter is set to "2LL" or "3LL", only the fifth screen (system power) and the sixth screen (system power factor & frequency) will be displayed.

When the meter is set to "1LN", there are only phase A power and phase A power factor display.

When the meter is set to "1LL", there are no phase C power and phase C power factor display.

c) Phase Angles and Unbalance:

Press H to display phase angles and unbalance data. The screen will roll to the next page when H is pressed again. It will go back to the first screen if you press H at the last screen.

The following figure shows the sequence:

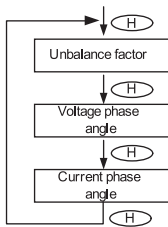

When using "2LL" or "3LL" wiring setting mode, voltage stands for line to line voltage. Otherwise, voltage stands for line-to-neutral voltage.

When the meter is set to "1LN", there is only phase A current to phase A voltage angle display.

When the meter is set to "1LL", there is no phase C voltage or current to phase A voltage angle factor display.

d) Energy:

Press E key to display energy and real time clock. The screen will roll to the next page when E is pressed again. It will go back to the first screen if you press E at the last screen.

Acuvim II series meter can be set to record primary energy or secondary energy. The unit of energy is kWh for active energy, kvarh for reactive energy and kVAh for apparent energy. The running time has a resolution of 0.01h. The meter begins accumulating time upon initial powering up of the unit. The accumulated time is stored in the non-volatile memory. It can be reset via communication or from the meter front.

The following figure shows the sequence:

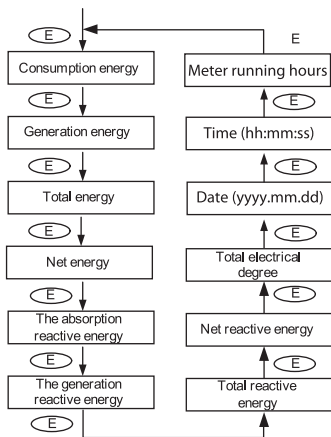

e) TOU display

Press "P" and "E" simultaneously to enter the TOU Energy and maximum demand page. Press "E" display the TOU energy. Press "P" display the TOU maximum demand. Press again display the TOU maximum demand year, month and date. Press again display the TOU maximum demand hour, minute and second. Press "H" would change the tariffs page. It displays energy under different tariffs in the energy page. It also displays demand under different tariffs in the maximum demand page. Press "V/A" would display different type energy and maximum demand. Press "P" and "E" simultaneously to exit current page and return to metering mode.

The following figure shows the sequence:

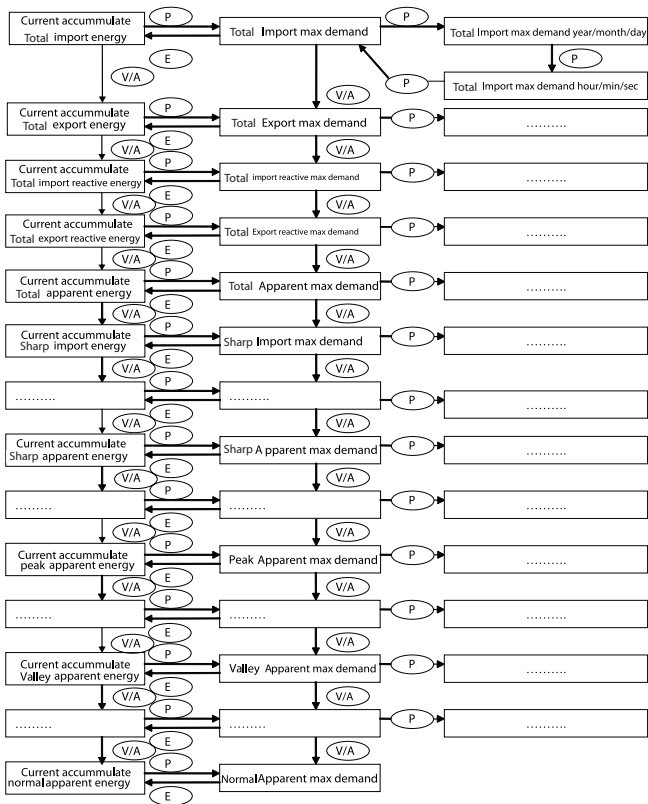

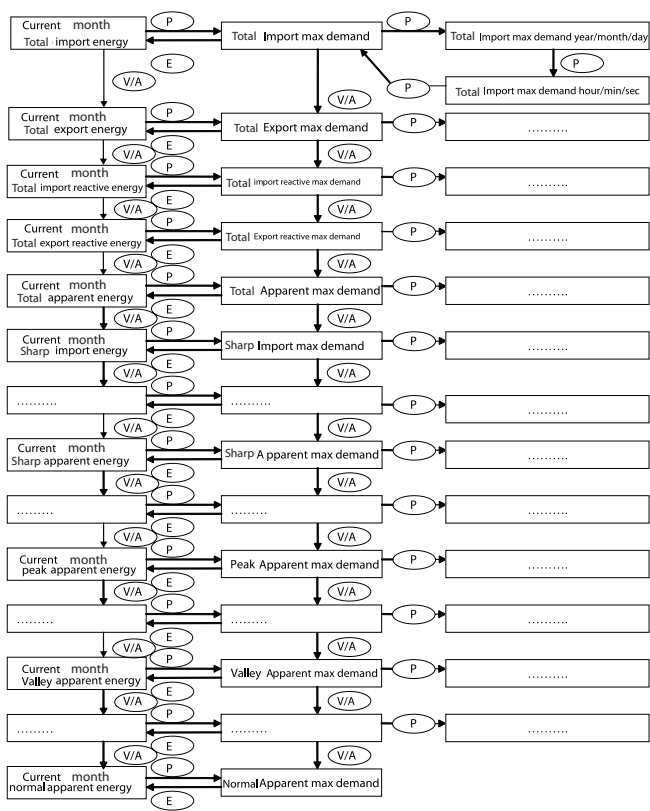

3.3 Statistics Data

Pressing H and V/A simultaneously will activate the display mode selection and the cursor will flash. Press P or E to move the cursor right or left. To enter the statistics data mode, scroll the cursor to "Max/Min" then press V/A.

In statistics data mode, the meter displays the maximum values and minimum values for voltage, current, power, power factor, unbalance, demand, THD etc. User should note that time stamp for the parameters can be viewed only from the software through communication. No commands are associated with the key H in "Max/Min" display mode.

When P is pressed again, the screen will roll to the next page, and will roll back to the first screen when pressed at the last page.

When E is pressed the screen will roll back to the previous page, and will roll back to the last screen when pressed at the first page.

Press V/A to switch the view between maximum and minimum. For example, if the current display is the maximum phase voltage value, when V/A is pressed, the display will show the minimum phase voltage value. If V/A is pressed again, the display will switch back to show the maximum phase voltage value.

The following figure shows the sequence:

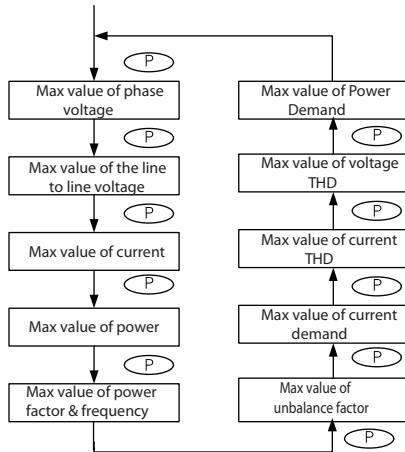
**Note:**

- i) The figure shows the rolling sequence when pressing P. The sequence will be reversed when pressing E.
- ii) When the meter is set to "2LL" or "3LL", the first screen(max value of phase voltage) will not be displayed.
- iii) When the meter is set to "1LL", there are no such displays as phase C voltage, Ubc and Uca line voltage, phase C current, three phase voltage and current unbalance factor, Uc and Ic THD, phase C current demand, etc.
- iv) When the meter is set to "1LN", there is only phase A display of phase voltage and current, only Ua and Ia THD display, only demand display of phase A. And there are no such displays as three phase voltage and current unbalance factor, line voltage, etc.

3.4 Demand Data

Pressing H and V/A simultaneously will activate the display mode selection and the cursor will flash. Press P or E to move the cursor right or left. To enter demand mode, move the cursor to "Demand" then press V/A.

In the demand data mode, the first screen displays the demand of active power, reactive power and apparent power, and the second screen displays the current demand of phase A, phase B and phase C. When the meter is set to "1LL", there is no phase C current demand display. When the meter is set to "1LN", there are no phase B and C current demand display.

As shown in the figure, system active power demand is 3.285kW, system reactive power demand is 0 kvar, system apparent power demand is 3.285 kVA.

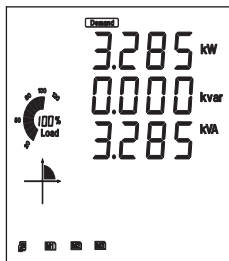

3.5 Harmonic Data

Pressing H and V/A simultaneously will activate the display mode selection and the cursor will flash. Press P or E to move the cursor right or left. To enter harmonic mode, move the cursor to "Harmonic" then press V/A.

In the harmonic data mode, meter displays the harmonic ratio of voltage and current, THD, odd HD, even HD, THFF, CF and KF.

a) Power Quality Data:

Press H to display power quality data. When H is pressed again, the screen will roll to the next page and will roll back to the first screen when pressed at the last page.

No commands are associated with keys P and E in "Harmonic" display mode.

Press V/A to switch to harmonic ratio data display.

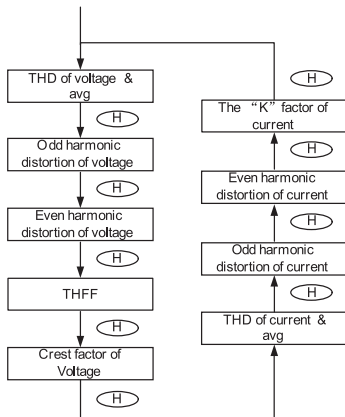

Note: When the meter is set to "1LN", there is only phase A display for voltage THD, voltage odd HD, voltage even HD, THFF, voltage crest factor, current THD, current odd HD, current even HD, and current K factor.

When the meter is set to "1LL", there is no phase C display.

b) Harmonic Ratio Data

Press H to switch to power quality data display.

The harmonic order will increase by one each time P is pressed and will return to the 2nd when P is pressed at the 63rd harmonic.

The harmonic order will decrease by one each time E is pressed and will return to the 63rd when E is pressed at the 2nd harmonic.

Press V/A to switch display between voltage harmonics and current harmonics.

The following figure shows the sequence:

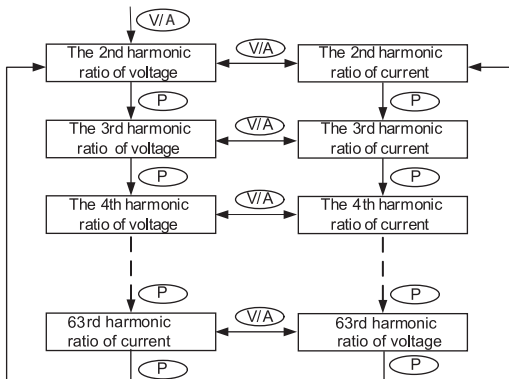

Note:

1. The figure shows the rolling sequence when pressing P. If E is pressed, the sequence will reverse.
2. Harmonic is 2nd~63rd.

3. When the meter is set to "1LN", there is only phase A display for voltage and current harmonic magnitude.
4. When the meter is set to "1LL", there is no phase C display for voltage and current harmonic magnitude.

3.6 Expanded I/O Module Data

Pressing H and V/A simultaneously will activate the display mode selection and the cursor will flash. Press P or E to move the cursor right or left. To access data from the expanded I/O modules, move the cursor to "Digital I/O" then press V/A to enter the expanded I/O module data mode.

In the expanded I/O module data mode, the meter displays the data from expanded I/O modules, such as DI status, pulse counter number, relay status, analog input, and analog output etc.

In this mode, the first page is module selection. You can choose to view the available modules that are attached to the meter. If no expanded I/O modules are connected, the screen will display "NO IO".

a) Module Selection:

No commands are associated with the key H in the module selection screen.

Press P to move the cursor downwards, the cursor will move to the top when it reaches the bottom. If only one module is connected, Pressing P will have no effect.

Press E to move the cursor upwards, the cursor will move to the bottom when it reaches the top. If only one module is connected, Pressing E will have no effect.

Press V/A to select the module and enter the I/O module data selection mode.

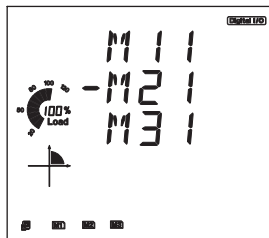

As shown in the figure, three modules are connected, AXM-IO11, AXM-IO21, AXM-IO31, which are indicated by M11, M21, M31 respectively. The cursor points to M21, which indicates that AXM-IO21 is chosen now.

b) I/O Module Data Selection

Press H to return to module selection screen.

Press P to move the cursor downwards, the cursor will move to the top when it reaches the bottom. Please note that there are 3 parameters for AXM-IO1, 3 parameters for AXM-IO2 and 4 parameters for AXM-IO3.

Press E to move the cursor upwards, the cursor will move to the bottom when it reaches the top.

Press V/A to select the parameter and enter the display of the data.

c) I/O module data display

Press H to return to I/O module data selection screen.

The screen will roll to the next page each time P is pressed and will return to the first page when P is pressed at the last page. If only one page exists, pressing P will have no effect.

The screen will roll to the last page each time E is pressed and will return to the last page E is pressed at the first page. If only one page exists, pressing E will have no effect.

No commands are associated with the key V/A in this display.

The following figure shows the sequence:

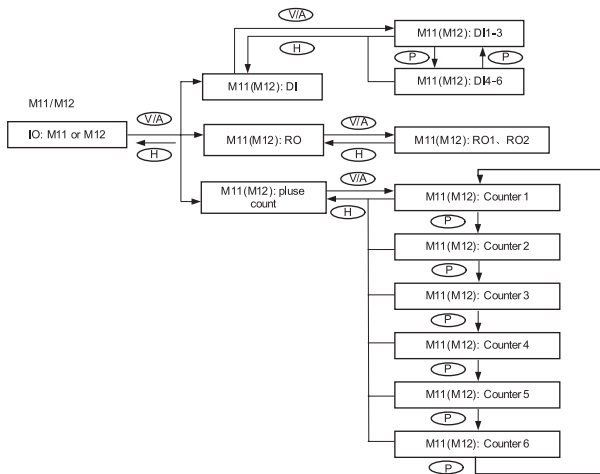

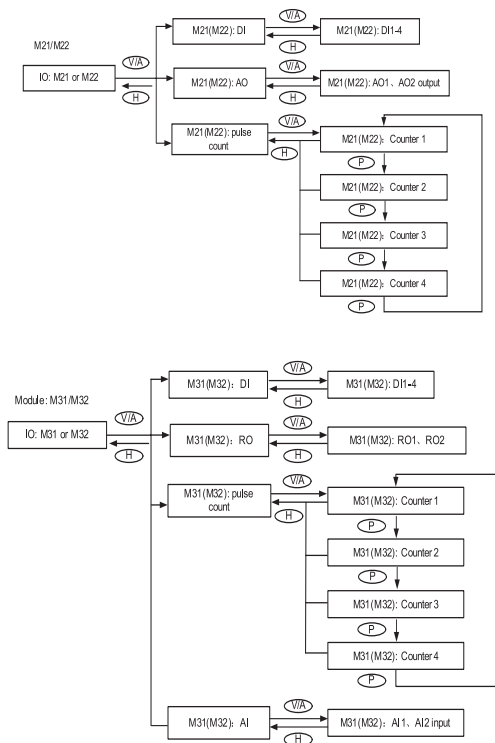

Note: The figure shows the rolling sequence for using key P. If using E key for rolling page, the sequence will reverse.

3.7 Parameter Setting Mode

Pressing H and V/A simultaneously will activate the display mode selection and the cursor will flash. Press P or E to move the cursor right or left. To enter parameter setting mode, move the cursor to "Setting" then press V/A.

In the parameter setting mode, parameters such as system parameters, expanded I/O module parameters, alarm parameters and Ethernet module parameters, can be read and modified.

a) Password Inquiry:

Parameter setting mode is password protected. Before entering the password and getting into the parameter setting mode, the meter's device communication address will display for 3 seconds. A four digit password (0000 to 9999) is required everytime before accessing the parameter setting mode. The default password is 0000. After entering the password, press V/A to go to the parameter selection page. The meter will be still in the password inquiry page if a wrong password is entered.

The following figure shows the password inquiry page.

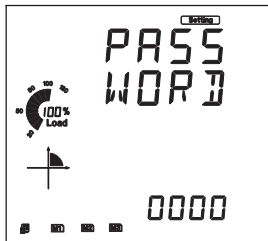

To input password:

Press H to move the flashing cursor to the next position.

Press P to increase the number by 1.

Press E to decrease the number by 1.

Press V/A to confirm the password.

b) Parameter Selection Mode

There are four parameters to choose from in the parameter selection manual: system, expanded I/O module, Ethernet module and alarm.

No commands are associated with the H key in the parameter selection manual.

Press P to move the cursor downwards, the cursor will move to the top when it reaches the bottom.

Press E to move the cursor upwards, the cursor will move to the bottom when it reaches the top.

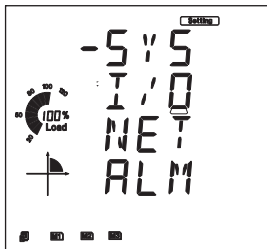

Press V/A to select and modify the parameter. The figure shows the parameter selection page. "SYS" stands for system parameter, "I/O" stands for expanded I/O module parameter, "NET" stands for Ethernet module parameter or BACnet module parameter ("MESH" stands for mesh module) and "ALM" stands for alarm parameter. As shown in the figure, the cursor points to the "SYS", which

means system parameter is selected.

c) System Parameter Setting

Users can select and modify system parameter in the system parameter setting mode.

Key functions for selecting a parameter:

Press H to return to parameter selection mode.

The screen will roll to the next page each time P is pressed and will return to the first page when P is pressed at the last page.

The screen will roll to the last page each time E is pressed and will return to the last page when E is pressed at the first page.

Press V/A to modify the selected parameter.

Key functions for modifying the parameter:

Press H to move the flashing cursor to the next position.

Press P to increase the number by 1.

Press E to decrease the number by 1.

Press V/A to confirm the modification and return to parameter selection mode.

The following figure shows the sequence:

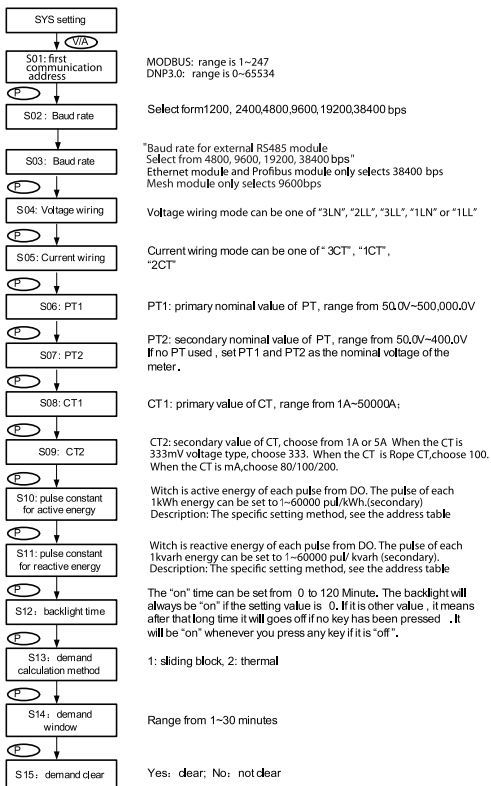

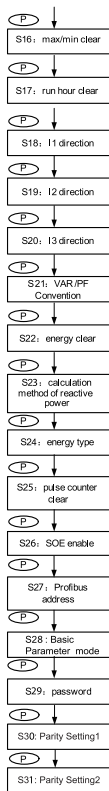

To clear the Max and Min value does not mean write 0 to all the registers, it will copy the metering value to the statistic registers and start a new statistic period.

Yes: clear; No: not clear

To adjust polarity of current, the three current's direction can be set as "Negative" which means reversing 180 degrees and "Positive" which means normal.

0: IEC, 1: IEEE

Yes: clear; No: not clear

0: true
1: generalized $Q = \sqrt{S^2 - P^2}$

Pre: primary energy;
Sec: secondary energy

Range from 0-6,
0: not clear; 1: AXM-I011 clear; 2: AXM-I021 clear; 3: AXM-I031 clear; 4: AXM-I012 clear; 5: AXM-I022 clear; 6: AXM-I032 clear;

Range from 0-6,
0: disable; 1: AXM-I011 enable; 2: AXM-I021 enable; 3: AXM-I031 enable; 4: AXM-I012 enable; 5: AXM-I022 enable; 6: AXM-I032 enable;

Any integer from 0-126

Pre: prim ary basic param eters
Sec : secondary basic param eters

Last page of the system parameter setting. Set the password in this page and make sure to remember the new password, or you may not use the meter properly.

Onboard RS485 port Parity setting. It can be selected from NON1, NON2, Odd and Even. NON1 represents non-parity, single stop bit; NON 2 represents non-parity, double stop bit; odd represents odd-parity, single stop-bit; even represents even parity, single stop bit. By default it is set as NON1.

RS485 module Parity setting. It can be selected from NON1, NON2, Odd and Even. Please refer to S31 for each selection details. By default it is set as NON1. When user selects NET module or Profibus module or Mesh module, Parity setting 2 should set NON1.

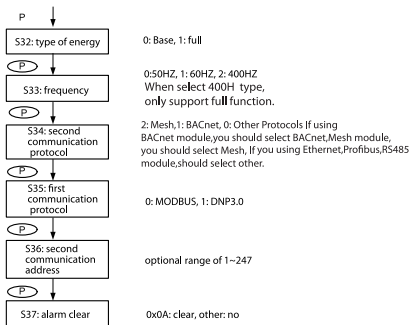

Note: The figure shows the rolling sequence for using the P key. If using the E key for rolling page, the sequence will reverse.

d) Expanded I/O Module Parameter

In the expanded I/O module parameter mode, user can choose to view the available modules that are attached to the meter and modify their parameters. If no expanded I/O modules are connected, the screen will display "NO IO". To return to system parameter setting mode main menu, press H (no commands are associated with other keys in this screen).

Key functions for I/O module selection:

Press H to return to parameter selection mode.

Press P to move the cursor downwards. The cursor will move to the top when it reaches the bottom. If there is only one module connected, pressing P will have no effect.

Press E to move the cursor upwards, the cursor will move to the bottom when it reaches the top.

If there is only one module connected, pressing E will have no effect.

Press V/A to select the module and enter the I/O module parameter setting mode.

Key functions for setting the I/O module parameter:

Press H to return to I/O module selection mode.

The screen will roll to the next page each time P is pressed and will return to the first page when P is pressed at the last page.

The screen will roll to the last page each time E is pressed and will return to the last page when E is pressed at the first page.

Press V/A to modify the selected parameter.

Key functions for modifying the parameter:

Press H to move the flashing cursor to the next position.

Press P to increase the number by 1.

Press E to decrease the number by 1.

Press V/A to confirm the modification and return to parameter selection mode.

The following table shows the sequence:

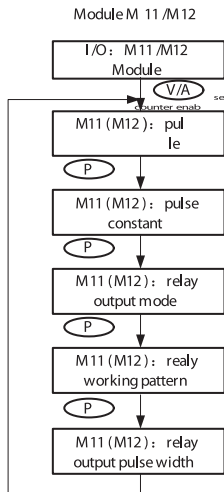

DI of AXM-IO1 can be used as the pulse counter, each DI function corresponds to one bit of a 6-bit register. The correspondence bit of 0 means that the DI works as the digital status input and the correspondence bit of 1 means that the DI works as the pulse counter. For example, if the setting value is 000001, it means that DI1 is set as the pulse counter and other DIs work as digital status inputs.

If the DI works as a pulse counter, when the number of pulses counted by the DI equals to the pulse constant, the pulse counter will increase by one. This means that the actual pulse number equals the number of pulses counted multiplied by the pulse constant.

Relays of AXM-IO1 can be used as alarm output or control output.
ALM:alarm output; CTRL:control output

When set as control output, relays have two control methods: latch or pulse.

LATCH:latch mode; PUL:pulse mode

If relay pulse control method is selected, the relay contact will close for a preset period and open afterwards. The pulse width range is 50~3000 ms.

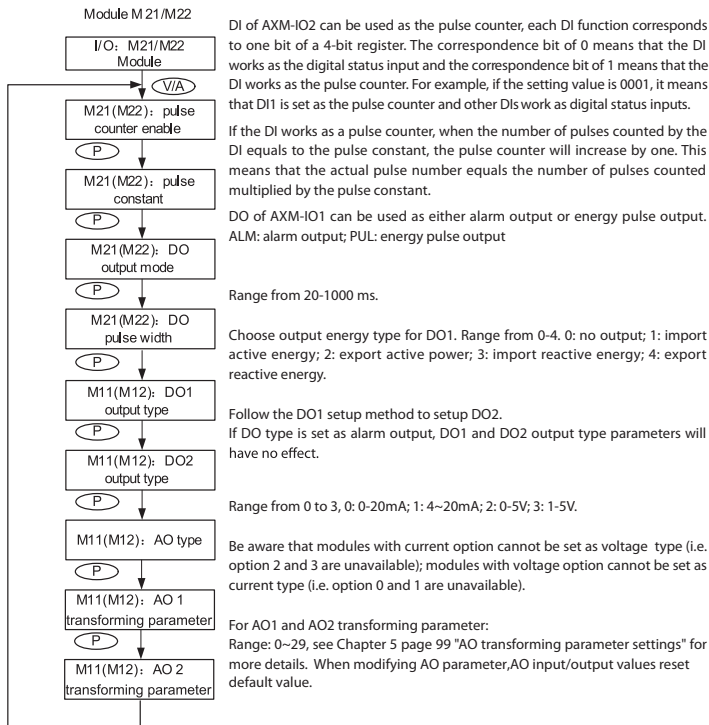

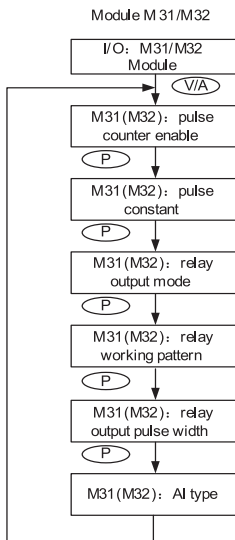

DI of AXM-IO3 can be used as the pulse counter, each DI function corresponds to one bit of a 4-bit register. The correspondence bit of 0 means that the DI works as the digital status input and the correspondence bit of 1 means that the DI works as the pulse counter. For example, if the setting value is 0001, it means that DI1 is set as the pulse counter and other DIs work as digital status inputs.

If the DI works as a pulse counter, when the number of pulses counted by the DI equals to the pulse constant, the pulse counter will increase by one. This means that the actual pulse number equals the number of pulses counted multiplied by the pulse constant.

When set as control output, relays have two control methods: latch or pulse

Relays of AXM-IO3 can be used as alarm output or control output. ALM:alarm output; CTRL:control output

If relay pulse control method is selected, the relay contact will close for a preset period and open afterwards. The pulse width range is 50~3000 ms.

Range from 0 to 3. 0: 0~20mA; 1: 4~20mA; 2: 0~5V; 3: 1~5V.

Be aware that modules with current option cannot be set as voltage type (i.e. option 2 and 3 are unavailable); modules with voltage option cannot be set as current type (i.e. option 0 and 1 are unavailable).

Note: The figure shows the rolling sequence for using key P. If using key E for rolling page, the sequence will reverse.

e) BACnet and Ethernet Module Parameter

When the second communication protocol is set to BACnet, there is parameters display related to BACnet, while these pages only show as modules successfully connecting with meter. If meter does not detect any module, there will show LOADING page. To set these parameters, first, select, then modify and save. On the one side, if there is no extra BACnet module, setting will be meaningless and not saved after shutting down. On the other side, setting is valid and will be saved into BACnet module when there is a BACnet module attached.

When the second communication is set to MESH, where is parameter display related to MESH module.

When second communication protocol is other protocol, there is parameters display related to Ethernet. The condition is same as above.

Key functions for finding the Ethernet module parameter:

Press H to return to parameter selection mode.

The screen will roll to the next page each time P is pressed and will return to the first page when P is pressed at the last page.

The screen will roll to the last page each time E is pressed and will return to the last page when E is pressed at the first page.

Press V/A to modify the selected parameter.

Key functions for modifying the parameter:

Press H to move the flashing cursor to the next position.

Press P to increase the number by 1, while the number was 9(Ethernet), or 7(BACnet IP), or 3(BACnet MS/TP), the number will return to 0 after press P.

Press E to decrease the number by 1, while the number was 0, the number will return to 9(Ethernet), or 7(BACnet IP), or 3(BACnet MS/TP) after press E.

Press V/A to confirm the modification and return to parameter selection mode.
The following figure shows the sequence of Ethernet module.

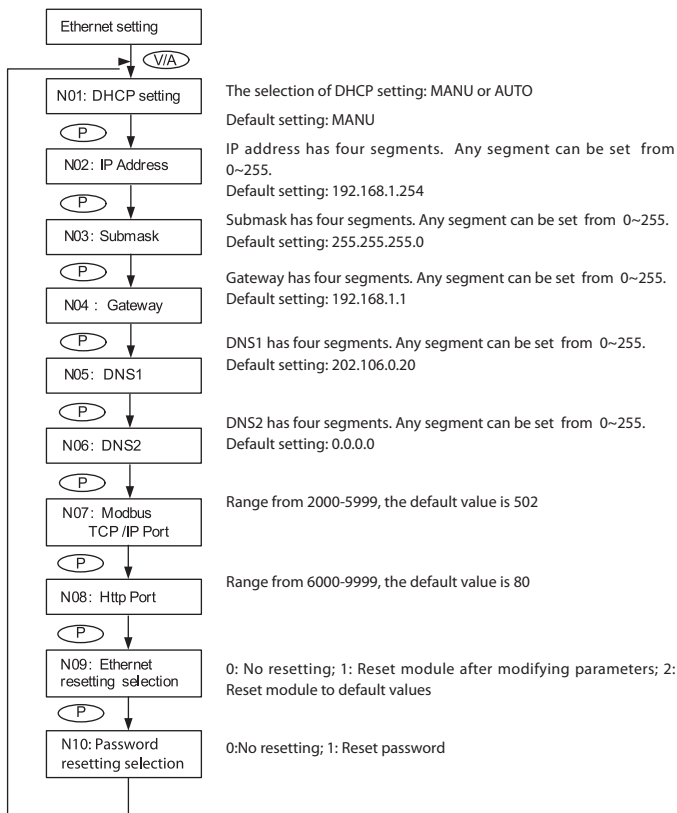

Note: The figure shows the rolling sequence for using key P. If using E key for rolling page, the sequence will reverse.

BACnet IP module rolling sequence:

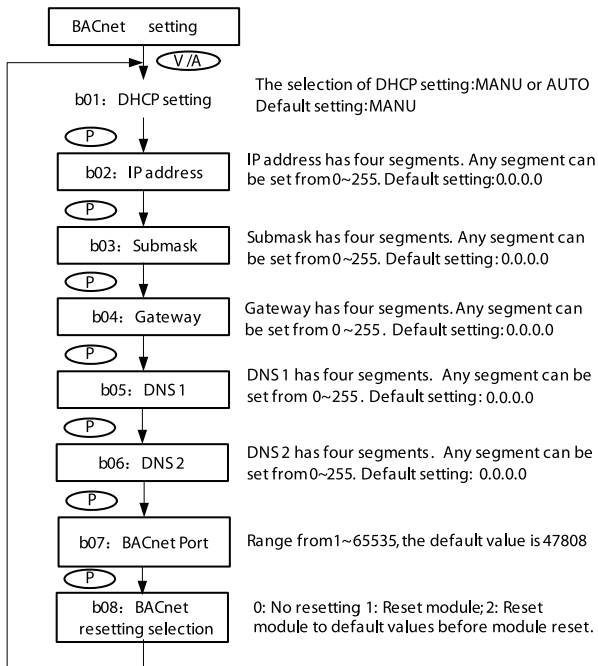

BACnet MS/TP module rolling sequence

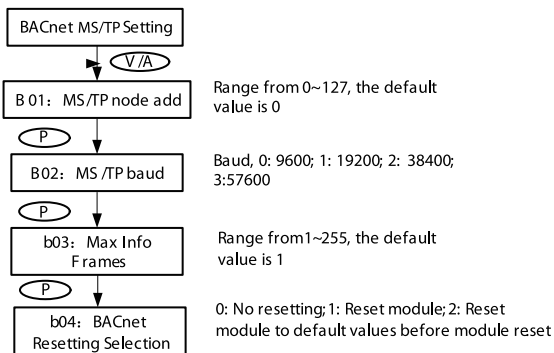

MESH module interface part

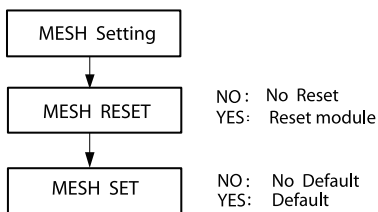

f) Alarm Parameter

In the alarm parameter mode, user can view and modify the parameters.

Key functions for finding the alarm parameter:

Press H to return to parameter selection mode.

The screen will roll to the next page each time P is pressed and will return to the first page when P is pressed at the last page.

The screen will roll to the last page each time E is pressed and will return to the last page when E is pressed at the first page.

Press V/A to modify the selected parameter.

Key functions for modifying the parameter:

Press H to move the flashing cursor to the next position.

Press P to increase the number by 1.

Press E to decrease the number by 1.

Press V/A to confirm the modification and return to parameter selection mode.

The following figure shows the sequence:

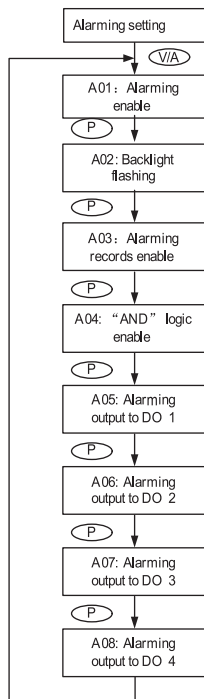

Yes: Alarm enable; No: Alarm disable

It can be selected as cue signal for alarming.

Yes: backlight flashes upon alarm condition; No: no backlight flashing

There are 16 alarm channels available. Each channel is controlled and enabled 1 bit each from a 16-bit register. Bit value of 1 means that the corresponding alarm channel is enabled whereas 0 means that the channel is disabled. The meter will display the value of this 16-bit register in decimal numbers (for different channel combination). For example, 00000 means that all channels are disabled; 00001 means only the first channel is enabled; 65535 means that all channels are enabled. Refer to section 4.4 on page 65 for more details.

"AND" logic relationship can be set among channels. When an "AND" logic is in place, both channels have to be triggered before the meter sends out the alarm signal. The logic can be set according to the predefined rule (refer to section 4.4 for more details). User can setup up to 8 logic relationships for alarming. Each logic relationship is controlled and enabled 1 bit each from a 16-bit register (only the lower 8 bits are used). Bit value of 1 means that the corresponding logic relationship is enabled whereas 0 means that the relationship is disabled. The meter will display this 8-bit value in decimal numbers (for different relationship combination). For example, 000 means that all relationships are disabled; 001 means only the first relationship is enabled; 255 means that all relationships are enabled.

When DO1 works in alarming mode, a 16-bit register is used to control which channels are associated with this output. Similar to the alarm channel selection, this 16-bit value is expressed in decimal when reading on the meter front. For example, 00000 means that no alarm channels are associated to this output; 00001 means that alarm channel 1 is associated to DO1; 65535 means that all alarm channels are associated to DO1. Refer to section 4.4 for more details.

If 2 AXM-IO2 modules are attached to the meter, DO1 and DO2 denote to the first and the second DO channel of AXM-IO21; DO3 and DO4 denote to the first and the second DO channel of AXMIO22 respectively. DO2, DO3 and DO4 use the same setup method as DO1.

Note: The figure shows the rolling sequence for using key P. If using E for rolling page, the sequence will reverse.

3.8 Page Recovery Function

Acuvim II series meter has a page recovery function. This means that the meter stores current display page in the non-volatile memory upon power loss and reloads the page when power recovers. If power goes off when viewing under the parameter setting mode, the meter will show voltage display when power recovers. If power goes off when viewing under the expanded I/O module data mode, and if this expanded I/O module is not connected when power recovers, the meter will show the voltage display page instead.

Chapter 4 Detailed Functions and Software

4.1 Basic Analog Measurements

4.2 Max/Min

4.3 Harmonics and Power Quality Analysis

4.4 Over/Under Limit Alarming

4.5 Data Logging

4.6 Time Of Use(TOU)

*4.7 Power Quality Event Logging and Waveform
Capture*

4.8 Seal function

The Acuvim II series meter contains advanced metering tools and is able to measure a multitude of power, energy and power quality parameters. Some advanced functions may not be accessible directly from the meter front; therefore, every meter comes with a powerful software that helps access the information. This chapter introduces these functions and the software.

4.1 Basic Analog Measurements

Acuvim II series meter can measure voltage, current, power, frequency, power factor, demand, etc. With high accuracy, as shown via the software below:



Fig 4-1 Real-Time Metering

Demand:

This meter consists of several types of demand calculation: total active power demand, total reactive power demand, total apparent power demand, phase A current demand, phase B current demand, and phase C current demand. When demand is reset, demand memory registers are set as 0.

Demand calculating mode can be set as sliding window and thermal according to user. The Fig 4-7 shows how it works.

When using the sliding window interval method, user selects an interval from 1 to 30 minutes, which is the period of the calculation. The demand updates every 1 minute as the window slides once.

Thermal demand method calculates the demand based on a thermal response which mimics a thermal demand meter. User selects the period for the calculation and the demand updates at the end of each period.

Energy:

This meter measures and accumulates energy in different directions (import and export). For real-time energy monitoring, it accumulates energy for kWh, kvarh and kVAh continuous (since its last reset).

Calculating mode

1. User can select different energy calculating modes, fundamental based or full-wave based either from the meter front or via communication. Fundamental based calculating is used to accumulate energy without taking harmonics into consideration while full-wave based calculating is used to accumulate energy including fundamental and harmonics.

Note: 1)When fundamental based calculating mode is selected, PF calculation will be based on the fundamental wave.

2)When selecting 400Hz type,only support full-wave.

2. There are two ways to calculate reactive energy(power)

Mode 0: real reactive energy $Q = \sqrt{S^2 - P^2 - D^2}$

Mode 1: general reactive energy $Q = \sqrt{S^2 - P^2}$

3. User can choose primary energy or secondary energy either by pressing keys from the meter front or via communication as shown in Fig 4-7.

Note: Acuvim II is able to display either primary energy or secondary energy on the LCD screen; however, it is only able to send out pulses according to secondary energy via the AXM-IO module.

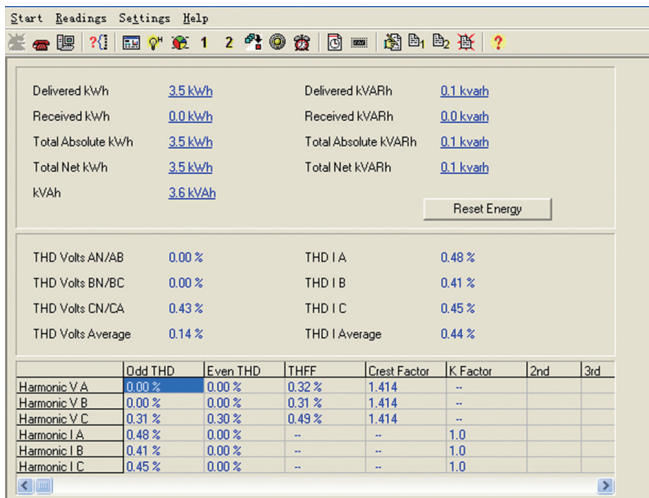

Fig 4-2 Energy and Power Quality Parameters

Current direction adjustment

Under normal circumstances, current flows from input terminal 1 to terminal 2 (i.e. from I11 to I12 for phase A current); however, current may flow in the opposite direction due to incorrect wiring setup. Instead of rewiring the system, the meter provides users an option to reverse the polarity of the current. By default, current direction is set as "positive", to reverse the current polarity by 180 degrees, user can set current direction as "negative". Refer to Fig 4-7 for more details.

Channel	Maximum	Time Stamp	Minimum	Time Stamp
Volts AN	237.2 V	2009-3-6 12:48:40	0.0 V	2009-3-6 11:34:40
Volts BN	236.3 V	2009-3-6 12:48:40	0.0 V	2009-3-6 11:34:40
Volts CN	232.2 V	2009-3-6 12:48:40	0.0 V	2009-3-6 11:34:40
Volts AB	398.5 V	2009-3-6 13:54:42	0.0 V	2009-3-6 11:34:40
Volts BC	408.8 V	2009-3-6 12:48:40	0.0 V	2009-3-6 11:34:40
Volts CA	404.6 V	2009-3-6 12:48:41	0.0 V	2009-3-6 11:34:40
I A	7.825 A	2009-3-6 12:43:27	0.000 A	2009-3-6 11:34:40
I B	9.859 A	2009-3-6 12:43:27	0.000 A	2009-3-6 11:34:40
I C	5.271 A	2009-3-6 12:48:40	0.000 A	2009-3-6 11:34:40
Watt Total	4.266 kW	2009-3-6 12:43:27	0.000 kW	2009-3-6 11:34:40
VAR Total	0.387 kvar	2009-3-6 12:36:11	-1.370 kvar	2009-3-6 12:43:27
VA Total	4.508 kVA	2009-3-6 12:43:27	0.000 kVA	2009-3-6 11:34:40
Pwr Factor Total	1.000	2009-3-6 11:01:29	-0.745	2009-3-6 14:21:20
Frequency	65.02 Hz	2009-3-6 14:22:31	0.00 Hz	2009-3-6 11:53:53
Watt Total (Demand)	3.301 kW	2009-3-6 11:39:59	0.000 kW	2009-3-6 11:01:29
VAR Total (Demand)	0.059 kvar	2009-3-6 11:14:23	0.000 kvar	2009-3-6 11:01:29
VA Total (Demand)	3.301 kVA	2009-3-6 11:39:59	0.000 kVA	2009-3-6 11:01:29
Unbalance V	49.9 %	2009-3-6 12:37:45	0.0 %	2009-3-6 11:01:29
Unbalance I	50.0 %	2009-3-6 12:39:34	0.0 %	2009-3-6 11:01:29
THD Volts AN/AB	39.89 %	2009-3-6 11:02:14	0.00 %	2009-3-6 11:01:29
THD Volts BN/CA	18.97 %	2009-3-6 14:22:33	0.00 %	2009-3-6 11:01:29
THD Volts CN/BC	26.52 %	2009-3-6 14:22:33	0.00 %	2009-3-6 11:01:29
THD I A	14.46 %	2009-3-6 12:48:42	0.00 %	2009-3-6 11:01:29
THD I B	19.05 %	2009-3-6 12:48:42	0.00 %	2009-3-6 11:01:29
THD I C	17.98 %	2009-3-6 12:48:42	0.00 %	2009-3-6 11:01:29
Dmd I A	5.001 A	2009-3-6 11:06:23	--	--
Dmd I B	5.001 A	2009-3-6 11:39:59	--	--
Dmd I C	5.002 A	2009-3-6 11:39:59	--	--

Reset Max and Min

Fig 4-3 Max/Min

4.2 Max/Min

Acuvim II series meter logs maximum and minimum value statistics for phase/line voltages, current, power, reactive power, apparent power, power factor, frequency, demand, unbalance factor, THD as well as the time they occur. All data is stored in non-volatile memory so that statistic information can be preserved even when meter is shut off. All maximum and minimum data can be accessed via communication or from the meter front but time stamps can only be accessed via communication. Statistics can be cleared via communication or from the meter front.

4.3 Harmonics and Power Quality Analysis

1. Harmonics

Acuvim II series meter can measure and analyze THD, harmonics support 2nd to 63rd, even HD, odd HD, crest factor, THFF, K factor etc. They are shown in Fig 4-2.

Note:

When selecting 400Hz type, only support 2nd~15th harmonics;

2. Phase angle

Phase angle indicates the angle between phase A voltage and other voltage/current parameters. Angle ranges from 0 to 360 degrees. This function is to help users find out the relationship between all input signals avoiding wrong wiring. When it is set to "2LL" or "3LL", it gives out the phase angles of u23, u31, i1, i2, i3 corresponding to u12. When it is set to "3LN", it gives out the phase angles of u2, u3, i1, i2 and i3 corresponding to u1. When it is set to "1LL", it gives out the phase angles of u2, i1, i2 corresponding to u1. They are shown in Fig 4-4.

3. Sequence component and unbalance analysis

Acuvim II series meter is able to perform sequential analysis for the input signal. It looks at the positive sequence, negative sequence and zero sequence of

the fundamental frequency and performs unbalance analysis for voltage and current. Sequence components are shown in Fig 4-4, unbalance of voltage and current are shown in Fig 4-1.

Start Readings Settings Help			
Pos. Sequence Phasor V A:	220.1 + 0.2j		
Pos. Sequence Phasor I A:	4.998 + 0.112j		
Neg. Sequence Phasor V A:	0.0 + 0.0j		
Neg. Sequence Phasor I A:	0.003 + 0.118j		
Zero Sequence Phasor V A:	0.1 + -0.3j		
Zero Sequence Phasor I A:	-0.007 + 0.112j		
Ph Angle V AN (V AN)	0.0 °	Ph Angle I A (V AN)	356.4 °
Ph Angle V BN (V AN)	120.0 °	Ph Angle I B (V AN)	120.1 °
Ph Angle V CN (V AN)	240.0 °	Ph Angle I C (V AN)	240.1 °
Ph Angle V AB (V AB)	0.0 °	Ph Angle I A (V AB)	0.0 °
Ph Angle V BC (V AB)	0.0 °	Ph Angle I B (V AB)	0.0 °
		Ph Angle I C (V AB)	0.0 °

Fig 4-4 Sequence component and Phase angle

4.4 Over/Under Limit Alarming

Acuvim II series meter has over/under limit alarming capabilities. When the monitored parameter goes over/under the preset limit and stays at the level over the preset amount of time delay, the over/under limit alarm will be triggered. The over/under limit value and its time stamp will be recorded in the

alarming log. The meter can record up to 16 alarming records. When extended I/O modules are attached, digital outputs (DO) and relay outputs (RO) can be triggered upon alarm conditions and used to activate downstream devices such as a beacon light or a buzzer.

Before using the alarming function, alarm conditions such as logic dependency, target setpoint, time delay etc must be set correctly. Settings can be accessed and modified from the software via communication connection as shown in Fig 4-5.

Limit ID	Enable	Alarm Channel	Setting	Setpoint	Delay (ms)	AND	DO211	DO212	DO221	DO222	RO**
#1	<input checked="" type="checkbox"/>	Frequency (Hz)	<	20.00	300	<input checked="" type="checkbox"/>	<input checked="" type="checkbox"/>	<input checked="" type="checkbox"/>	<input checked="" type="checkbox"/>	<input checked="" type="checkbox"/>	<input checked="" type="checkbox"/>
#2	<input type="checkbox"/>	Frequency (Hz)	>	0.00	0	<input type="checkbox"/>	<input type="checkbox"/>	<input type="checkbox"/>	<input type="checkbox"/>	<input type="checkbox"/>	<input type="checkbox"/>
#3	<input type="checkbox"/>	Frequency (Hz)	>	0.00	0	<input type="checkbox"/>	<input type="checkbox"/>	<input type="checkbox"/>	<input type="checkbox"/>	<input type="checkbox"/>	<input type="checkbox"/>
#4	<input type="checkbox"/>	Frequency (Hz)	>	0.00	0	<input type="checkbox"/>	<input type="checkbox"/>	<input type="checkbox"/>	<input type="checkbox"/>	<input type="checkbox"/>	<input type="checkbox"/>
#5	<input type="checkbox"/>	Frequency (Hz)	>	0.00	0	<input type="checkbox"/>	<input type="checkbox"/>	<input type="checkbox"/>	<input type="checkbox"/>	<input type="checkbox"/>	<input type="checkbox"/>
#6	<input type="checkbox"/>	Frequency (Hz)	>	0.00	0	<input type="checkbox"/>	<input type="checkbox"/>	<input type="checkbox"/>	<input type="checkbox"/>	<input type="checkbox"/>	<input type="checkbox"/>
#7	<input type="checkbox"/>	Frequency (Hz)	>	0.00	0	<input type="checkbox"/>	<input type="checkbox"/>	<input type="checkbox"/>	<input type="checkbox"/>	<input type="checkbox"/>	<input type="checkbox"/>
#8	<input type="checkbox"/>	Frequency (Hz)	>	0.00	0	<input type="checkbox"/>	<input type="checkbox"/>	<input type="checkbox"/>	<input type="checkbox"/>	<input type="checkbox"/>	<input type="checkbox"/>
#9	<input type="checkbox"/>	Frequency (Hz)	>	0.00	0	<input type="checkbox"/>	<input type="checkbox"/>	<input type="checkbox"/>	<input type="checkbox"/>	<input type="checkbox"/>	<input type="checkbox"/>
#10	<input type="checkbox"/>	Frequency (Hz)	>	0.00	0	<input type="checkbox"/>	<input type="checkbox"/>	<input type="checkbox"/>	<input type="checkbox"/>	<input type="checkbox"/>	<input type="checkbox"/>
#11	<input type="checkbox"/>	Frequency (Hz)	>	0.00	0	<input type="checkbox"/>	<input type="checkbox"/>	<input type="checkbox"/>	<input type="checkbox"/>	<input type="checkbox"/>	<input type="checkbox"/>
#12	<input type="checkbox"/>	Frequency (Hz)	>	0.00	0	<input type="checkbox"/>	<input type="checkbox"/>	<input type="checkbox"/>	<input type="checkbox"/>	<input type="checkbox"/>	<input type="checkbox"/>
#13	<input type="checkbox"/>	Frequency (Hz)	>	0.00	0	<input type="checkbox"/>	<input type="checkbox"/>	<input type="checkbox"/>	<input type="checkbox"/>	<input type="checkbox"/>	<input type="checkbox"/>
#14	<input type="checkbox"/>	Frequency (Hz)	>	0.00	0	<input type="checkbox"/>	<input type="checkbox"/>	<input type="checkbox"/>	<input type="checkbox"/>	<input type="checkbox"/>	<input type="checkbox"/>
#15	<input type="checkbox"/>	Frequency (Hz)	>	0.00	0	<input type="checkbox"/>	<input type="checkbox"/>	<input type="checkbox"/>	<input type="checkbox"/>	<input type="checkbox"/>	<input type="checkbox"/>
#16	<input type="checkbox"/>	Frequency (Hz)	>	0.00	0	<input type="checkbox"/>	<input type="checkbox"/>	<input type="checkbox"/>	<input type="checkbox"/>	<input type="checkbox"/>	<input type="checkbox"/>

Save Load Update Device

Fig 4-5 Alarm Setting

1. Single Alarming Group Setting

Table 4-1 indicates the first group of settings, there are 16 groups in total with the same format.

Table 4-1 First Group of Alarming Settings

Address	Parameter	Range	Property
104EH	First group: parameter code	0~79	R/W
104FH	First group: comparison mode	1:larger,2:equal,3:smaller	R/W
1050H	First group: setpoint value	Related with parameters	R/W
1051H	First group: delay time	0~3000(*10ms)	R/W
1052H	First group: output to relay	0:none,1-8:related relay	R/W

Parameter code: select target parameter for alarm monitoring For example: 0-frequency, 44-AL4 sampling data.

Comparison mode: set alarming condition 1: greater than, 2: equal to, 3: smaller than. For example: if you choose target parameter to be "frequency", condition to be "greater than" and setpoint to be "50", alarm will be triggered when the frequency is greater than 50Hz.

Note: setpoint value is the same as the actual value of the selected parameter.

Delay time: If the alarms condition lasts for the preset time period, the alarm signal will be triggered. The delay range is from 0 to 3000 (unit: 10ms). When it is set to 0, there is no delay, alarm will be triggered when the alarm condition is met. If it is set to 20, there will be a 200ms (20 x 10ms) delay.

Output to relay: 0-alarming signal will not be sent to RO; if it is set as 1 and AXM-IO11 is connected, it will output to RO1 when alarm triggers. RO1 will be turned off when all alarms output to RO1 are cleared. RO2~RO8 work in the same manner as RO1.

- Note:** 1) If RO is under alarming mode, it can only work in "latch" mode.
2) If the number is 51~79, there are special guide for contrast method and meaning of parameters, please refer to Chapter 6.

After setting up the alarming parameters, user must also setup the global settings in order for the alarm to work properly.

2. Global settings

Register addresses for global alarm settings are from 1046H~104DH. Please refer to section 5.3, page 95 "Global alarming settings" for more details.

"Global alarming enable" determines whether the alarming function of the meter is activated or not. The alarming function is enabled when it is set as "1".

When "Alarming flash enable" is set as "1", backlight will flash when alarm is triggered.

"Alarming channel enable setting" determines whether the corresponding alarm group is enabled or not. There are 16 groups in all and each one is corresponding to one bit of a 16-bit register. The corresponding bit must be set to "1" in order to activate the alarm channel.

Logic "AND" between alarm setting: The 16 alarming records in the meter are divided into 8 pairs. Each pair has two alarm groups. The two groups can be logically "AND" by controlling the logic check box. When two groups are "AND", alarming triggers only if both AND conditions are met. If the "AND" logic box is unchecked, the two alarm channels will work independently.

The 8 "AND" logic pairs are arranged as follows: 1st, 2nd channel form Pair 1; 3rd, 4th channel form Pair 2; 5th, 6th channel form Pair 3; 7th, 8th channel form Pair 4; 9rd, 10th channel form Pair 5; 11th, 12th channel form Pair 6; 13th, 14th channel form Pair 7; 15th, 16th channel form Pair 8.

This function is controlled by the lower 8 bits of the 16-bit register and each bit is corresponding to a pair. "1" means this function is enabled and "0" means disabled.

"Alarming output to DO1 setting": When "Digital output mode" is set to "1", DO1 can be used as alarming output. A 16-bit register is used to perform this function, its bit0~bit15 correspond to the 1st ~16th group respectively. When the related I/O module is connected and is under alarming mode, and if the corresponding bit is set to 1 and the alarming condition is met, alarm signal will be sent to DO1. DO1 will be turned off when all alarms correspond to DO1 are cleared. If related bit is set to 0, that alarm channel will not issue alarm signal to DO1. DO2~DO4 work in the same manner DO1.

After completing the setup steps correctly, alarming function can be used.

3. Setting Example

Here is an example showing how to apply the logic "AND" function for a pair of alarm channels.

The conditions are as follows: I1 greater than 180A, delay 5s for the 1st alarm channel; U1 less than 9980V, delay 10s for the 2nd alarm channel. No alarm signals will be sent to outputs. The CT primary value of I1 is 200A, and CT2 is 5A. The PT ratio for U1 is 10000:100. The following shows how all the related registers are to be set.

Settings of first group:

"Parameter code (104EH)" is set to 9, which stands for I1.

"Comparison mode (104FH)" is set to 1, which stands for "greater than".

"Setpoint value (1050H)" is set to 4500, according to the relationship between actual value and communication value ($I=R_x * (CT1/CT2) / 1000$).

"Delay time (1051H)" is set to 500, so the actual delay time is $500 * 10\text{ms} = 5\text{s}$.

"Output to relay (1052H)" is set to 0, because there is no output to RO.

Settings of second group:

"Parameter code (1053H)" is set to 1, which stands for U1.

"Comparison mode (1054H)" is set to 3, which stands for "smaller than".

"Setpoint value (1055H)" is set to 998, according to the relationship between actual value and communication value ($U = R_x \times (PT1/PT2) / 10$).

"Delay time (1056H)" is set to 1000, so the actual delay time is $1000 * 10\text{ms} = 10\text{s}$.

"Output to relay (1057H)" is set to 0, because there is no output to RO.

Global settings:

"Alarming channel enable setting (1048H)" set to 0003H to enable the first and the second channel.

"Logic "AND" between alarming setting (1049H)" set to 0001H to enable logic "AND" in Pair 1.

"Alarming output to DO1 setting (104AH)" set to 0, since no output to DO1.

"Alarming output to DO2 setting (104BH)" set to 0.

"Alarming output to DO3 setting (104CH)" set to 0.

"Alarming output to DO4 setting (104DH)" set to 0.

"Alarming flash enable (1047H)" set to 0 to disable backlight flashing when alarming occurs.

"Global alarming enable (1046H)" set to 1 to enable over/under limit alarming.

4. Records of Alarming Event

Acuwin II series meter has built in alarm logging capabilities. 16 entries can be recorded in total. The record sequence of these entries do not depend on the sequence of the 16 alarm channels. The meter begins logging alarm status starting from the 1st record location to the last one. Alarm logs are being recorded in a "cycle" fashion which means the latest event will overwrite the oldest record. When over/under limit parameters return to normal, its value and time stamp will be recorded as well. Therefore, users can determine the over/under limit duration by checking the time difference.

Here is the 1st group of records. Other groups of records have the same format.

Table 4-2 Alarming status of the 1st group of record

Address	Parameter	Range
42A9H	First group: alarming status	0~65535
42AAH	First group: parameter code	0~79
42ABH	First group: over/under limit or reset value	Related with parameters
42ACH~42B2H	First group: occur time: yyyy:mm:dd:hh:mm:ss:ms	time

"Alarming status" indicates information of current alarm status. It is a 16-bit unsigned integer. Parameter code is stored in the higher 8 bits. Bit1 indicates whether logic "AND" is enabled or not, 1 means enabled and 0 means not. Bit0 indicates whether alarming has occurred or recovered, 1 means occurred and 0 means recovered. Undefined bits are 0.

"Parameter code" specifies the monitored parameter.

"Value" shows the recorded value of the selected parameter when an alarm is triggered and when it recovers.

“Time” indicates the time stamp with the accuracy in milliseconds (ms).

Alarming event will set bit0 of “system status (102EH)” to be 1. When software send clear alarm command, Bit0 of “system status (102EH)” will be set to 0.

Alarming group number (1032H): the range is 0~16, 0 is no alarm record, and others stand for which record is newest alarm. Alarming group number can be saved during meter power off, and it is cycling recording.

Here is an example:

No.	Time Stamp	ms	Alarm Channel	Value	Status	Limit ID
1	2007-4-28 10:20:49	492	AI 311	0	Out	1
2	2007-4-28 10:20:50	514	AI 311	0	In	1
3	2007-4-26 16:46:01	594	AI 311	0	Out	1
4	2007-4-26 16:46:01	594	AI 311	0	Out	2
5	2007-4-26 16:46:23	901	AI 311	0	In	1
6	2007-4-26 16:46:23	901	AI 311	0	In	2
7	2007-4-23 16:12:27	969	THD I Average	0.00 %	In	1
8	2007-4-23 16:12:27	969	THD Volts Average	0.00 %	In	2
9	2007-4-23 16:12:33	64	THD I Average	0.00 %	Out	1
10	2007-4-23 16:12:33	64	THD Volts Average	0.00 %	Out	2
11	2007-4-23 16:12:37	816	THD I Average	0.00 %	In	1
12	2007-4-23 16:12:37	816	THD Volts Average	0.00 %	In	2
13	2007-4-23 16:13:00	217	THD I Average	0.00 %	Out	1
14	2007-4-23 16:13:00	217	THD Volts Average	0.00 %	Out	2
15	2007-4-23 16:13:20	358	THD I Average	0.00 %	In	1
16	2007-4-23 16:13:20	358	THD Volts Average	0.00 %	In	2

New Alarm Record? Yes

Newest Alarm Record No. 16

Fig 4-6 Alarming records

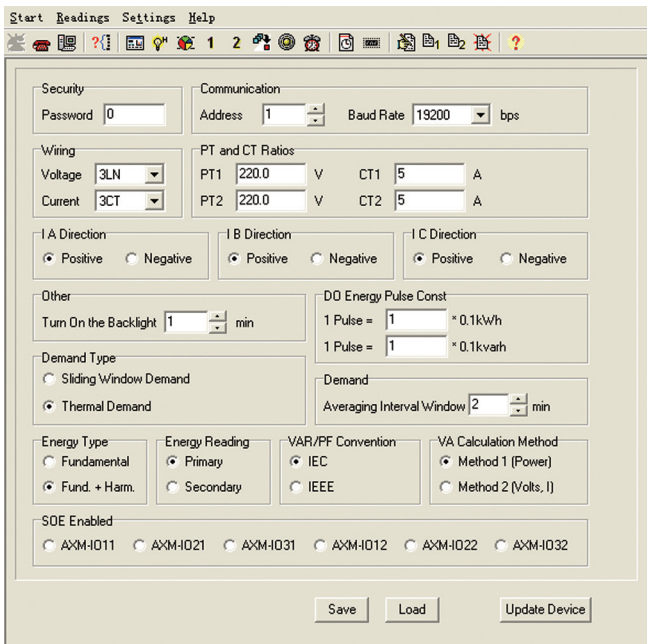

Fig 4-7 Basic settings

4.5 Data Logging

The Acuim IIR/IIIE/IIW meter provides data logging that records the data at a set interval. This meter has 8 MegaBytes of memory which gives it extensive data-logging capabilities. It has a real-time clock that allows logs to be time-stamped when log events are created.

1. Data log settings

The Acuvim IIR/IIIE/IIW meter has three sets of historical data logs. Each log can be independently programmed with individual settings, meaning that each can be used to monitor different parameters. You can program up to 117 parameters per log. You also have the ability to allocate available system resources among the three logs, to increase or decrease the size of the individual historical logs. The total size is no more than 100 sectors that has 64k bytes. The data log 1 setting is shown in Fig 4-8.

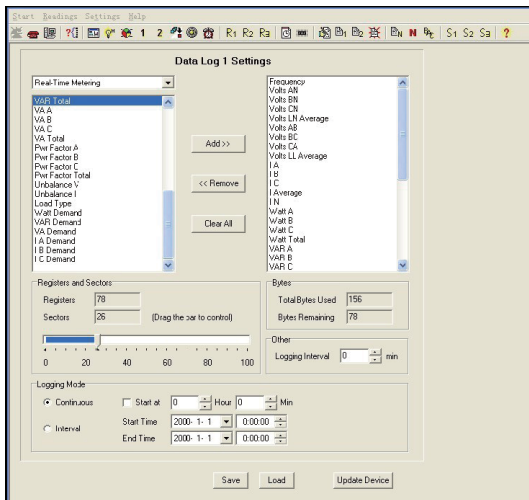

Fig 4-8 The data log 1 setting

Having three sets of historical logs provides you with the option of programming each log with unique parameters. For example, you can program Historical Log 1 to record measured values parameters (for example, Frequency, Voltage, Current), Log 2 to record energy values parameters, and Log 3 to record power quality parameters. Historical Log parameters can be selected from the following thirteen groups:

- Real-Time Metering (Frequency; Instantaneous Voltage; Instantaneous Current; Total and Per Phase Power and Power Factor; Neutral Current ; unbalance V/I; load type; Current demand; and Per Phase/ Total Power demand)
- Energy (Ep_imp; Ep_exp; Ep_total; Ep_net; Eq_imp; Eq_exp; Eq_total; Eq_net; Es; Epa_imp; Epa_exp; Epb_imp; Epb_exp; Epc_imp; Epc_exp; Eqa_imp; Eqa_exp; Eqb_imp; Eqb_exp; Eqc_imp; Eqc_exp; Esa; Esb; Esc)
- THD Volts AN/AB (THD, 2nd -63rd Harmonic Magnitudes, ODD, EVEN, CF and THFF of Volts AN/AB)
- THD Volts BN/BC (THD, 2nd -63rd Harmonic Magnitudes, ODD, EVEN, CF and THFF of Volts BN/BC)
- THD Volts CN/CA (THD, average THD, 2nd -63rd Harmonic Magnitudes, ODD, EVEN, CF and THFF of Volts CN/CA)
- THD IA (THD, 2nd -63rd Harmonic Magnitudes, ODD, EVEN, KF of IA)
- THD IB (THD, 2nd -63rd Harmonic Magnitudes, ODD, EVEN, KF of IB)
- THD IC (THD, average THD, 2nd -63rd Harmonic Magnitudes, ODD, EVEN, KF of IC)
- Sequence Component (positive, negative and zero sequence)
- Phase Angles (the angle between U1 and other voltage and current parameters.)

- DI Counter (the DI numbers of the IO modules)
- AO/AI Raw Value (the AO output register values and the AI sample register values)
- AO/AI Value(the AO output values and the AI sample values)

The following procedures show how to select and store parameters in historical log 1. The Group field determines the items that are available for selection.

1) Select a Group. The possible selections are: Real-Time Metering, Energy, THD Volts AN/AB, THD Volts BN/BC , THD Volts CN/CA , THD IA , THD IB , THD IC, Sequence Component, Phase Angles, DI Counter, AO/AI Raw Value and AO/AI Value.

2) Select items for your log:

- a. Highlight the parameter(s) you want to log into the meter's memory.
- b. Click Add to add the parameter to the Selected Parameter Area.
- c. To remove parameter(s), highlight them in the Selected Parameter Area and click Remove.

3) Set the logging interval (in minutes). Interval can be set from 0 - 1444 minutes according to different application.

The logging interval determines when the meter takes a snapshot. When interval is set as 0, the set of historical data log is disabled.

4) There are 100 sectors in total for the 3 historical data logs. User can assign different sector size to each log according to different applications (as long as the total sector sizes of the 3 logs do not exceed 100).

5) Three Modes of historical log:

A. Mode1: if correctly set historical log, can record without setting date and time, depending on first-in first-out recycling log.

B. Mode2: if correctly set historical log, as set date and time, can record within begin to end time. Record will stop after buffer is full.

C. Mode3: if correctly set historical log, as set hour and minute, only can record while the running time is equal to setting hour and minute, depending on first-in first-out recycling log.

NOTES:

- If the memory of the historical data log is full, the meter will erase the first sector in which the memory size is 65536 bytes (64kb). The following sector (the second sector) will become the first sector and the data from the erased sector will not be recoverable. Therefore, user should save the whole log before memory is full to maintain all the data.
- There are two display fields at the bottom of the data log setting screen. They show the registers in the logs ,the total bytes used and the bytes remaining for this historical log. These fields are updated as you make selections on the screen. The total number of bytes available per log record is approximately 234.

2. Retrieving logs

There are two ways of retrieving the logs: "read one window" and "read all".The retrieval screen is shown in Fig 4-9.

Record No	Time	VAR Total	VAL A	VAL B	VAL C	VAL Total	Pwr Factor A	Pwr Factor B	Pwr Factor C	Pwr Factor Tot	Unbalance V	Unbalance
11	2000-1-20 20:32:09	0.00000 kvar	0.00000 kVA	0.00000 kVA	0.00000 kVA	0.00000 kVA	1.000	1.000	1.000	0.0%	0.0%	0.0%
12	2000-1-20 20:33:09	0.00000 kvar	0.00000 kVA	0.00000 kVA	0.00000 kVA	0.00000 kVA	1.000	1.000	1.000	1.000	0.0%	0.0%
13	2000-1-20 20:34:09	0.00000 kvar	0.00000 kVA	0.00000 kVA	0.00000 kVA	0.00000 kVA	1.000	1.000	1.000	1.000	0.0%	0.0%
14	2000-1-20 20:35:09	0.00000 kvar	0.00000 kVA	0.00000 kVA	0.00000 kVA	0.00000 kVA	1.000	1.000	1.000	1.000	0.0%	0.0%
15	2000-1-20 20:36:09	0.00000 kvar	0.00000 kVA	0.00000 kVA	0.00000 kVA	0.00000 kVA	1.000	1.000	1.000	1.000	0.0%	0.0%
16	2000-1-20 20:37:09	0.00000 kvar	0.00000 kVA	0.00000 kVA	0.00000 kVA	0.00000 kVA	1.000	1.000	1.000	1.000	0.0%	0.0%
17	2000-1-20 20:38:09	0.00000 kvar	0.00000 kVA	0.00000 kVA	0.00000 kVA	0.00000 kVA	1.000	1.000	1.000	1.000	0.0%	0.0%
18	2000-1-20 20:39:09	0.00000 kvar	0.00000 kVA	0.00000 kVA	0.00000 kVA	0.00000 kVA	1.000	1.000	1.000	1.000	0.0%	0.0%
19	2000-1-20 20:40:09	0.00000 kvar	0.00000 kVA	0.00000 kVA	0.00000 kVA	0.00000 kVA	1.000	1.000	1.000	1.000	0.0%	0.0%
20	2000-1-20 20:41:09	0.00000 kvar	0.00000 kVA	0.00000 kVA	0.00000 kVA	0.00000 kVA	1.000	1.000	1.000	1.000	0.0%	0.0%
21	2000-1-20 20:42:09	0.00000 kvar	0.00000 kVA	0.00000 kVA	0.00000 kVA	0.00000 kVA	1.000	1.000	1.000	1.000	0.0%	0.0%
22	2000-1-20 20:43:09	0.00000 kvar	0.00000 kVA	0.00000 kVA	0.00000 kVA	0.00000 kVA	1.000	1.000	1.000	1.000	0.0%	0.0%
23	2000-1-20 20:44:09	0.00000 kvar	0.00000 kVA	0.00000 kVA	0.00000 kVA	0.00000 kVA	1.000	1.000	1.000	1.000	0.0%	0.0%
24	2000-1-20 20:45:09	0.00000 kvar	0.00000 kVA	0.00000 kVA	0.00000 kVA	0.00000 kVA	1.000	1.000	1.000	1.000	0.0%	0.0%
15	2000-1-20 45:09	0.00000 kvar	0.00000 kVA	0.00000 kVA	0.00000 kVA	0.00000 kVA	1.000	1.000	1.000	1.000	0.0%	0.0%
16	2000-1-20 46:09	0.00000 kvar	0.00000 kVA	0.00000 kVA	0.00000 kVA	0.00000 kVA	1.000	1.000	1.000	1.000	0.0%	0.0%
17	2000-1-20 47:09	0.00000 kvar	0.00000 kVA	0.00000 kVA	0.00000 kVA	0.00000 kVA	1.000	1.000	1.000	1.000	0.0%	0.0%
18	2000-1-20 48:09	0.00000 kvar	0.00000 kVA	0.00000 kVA	0.00000 kVA	0.00000 kVA	1.000	1.000	1.000	1.000	0.0%	0.0%
19	2000-1-20 49:09	0.00000 kvar	0.00000 kVA	0.00000 kVA	0.00000 kVA	0.00000 kVA	1.000	1.000	1.000	1.000	0.0%	0.0%
20	2000-1-20 50:09	0.00000 kvar	0.00000 kVA	0.00000 kVA	0.00000 kVA	0.00000 kVA	1.000	1.000	1.000	1.000	0.0%	0.0%
21	2000-1-20 51:09	0.00000 kvar	0.00000 kVA	0.00000 kVA	0.00000 kVA	0.00000 kVA	1.000	1.000	1.000	1.000	0.0%	0.0%
22	2000-1-20 52:09	0.00000 kvar	0.00000 kVA	0.00000 kVA	0.00000 kVA	0.00000 kVA	1.000	1.000	1.000	1.000	0.0%	0.0%
23	2013-2-24 10:14:17	0.00000 kvar	0.00000 kVA	0.00000 kVA	0.00000 kVA	0.00000 kVA	1.000	1.000	1.000	1.000	0.0%	0.0%
24	2013-2-24 10:15:17	0.00000 kvar	0.00000 kVA	0.00000 kVA	0.00000 kVA	0.00000 kVA	1.000	1.000	1.000	1.000	0.0%	0.0%
24	2013-2-24 10:16:17	0.00000 kvar	0.00000 kVA	0.00000 kVA	0.00000 kVA	0.00000 kVA	1.000	1.000	1.000	1.000	0.0%	0.0%

Fig 4-9 Retrieval screen

The "read one window" method allows you to access and read a specific log location at an offset from the first log. The "window record num" is the maximum number of record entries the software can read at a time, it is calculated by $246 / \text{Record Size}$. The larger this number is, the faster data can be retrieved. Log type is the logs you want to retrieve, for example, log type 0 is data logging 1, log type 1 is data logging 2 and log type 2 is data logging 3.

The "read all" method accesses and reads the historical data log automatically, the offset increases automatically until all the logs are retrieved.

The data logs contents are shown at the bottom of the page.

4.6 Time of use (TOU)

User can assign up to 4 different tariffs (sharp, peak, valley and normal) to different time period within a day according to the billing requirements. The meter will calculate and accumulate energy to different tariffs according to the meter's internal clock timing and TOU settings.

TOU setting: User can set a maximum of 12 TOU seasons, each season can be assigned to a TOU schedule (a maximum of 14 TOU schedules are available). Each schedule can be divided up into 14 segments (in which each segment can have its own tariff). User can customize the TOU calendar (including its tariffs, seasons, schedules and segments) according to different applications. To make sure that the TOU calendar is setup correctly, the meter will check the TOU settings according to the predefined rules (see below for "TOU setting format requirement" for details). TOU function will be disabled if the TOU calendar is set up incorrectly. If no errors are found in the calendar and the TOU function is enabled, TOU energy accumulation will begin.

TOU setting format requirement:

1. Season setting parameter: The calendar year will be divided up into different seasons depending on the season setting parameter. The parameter can be selected from any integer between 1 to 12. User must enter the correct value for the season setting parameter in accordance to the TOU season table. If the season setting parameter is set as 2, the first 2 slots of the TOU season table must be set, otherwise it will be considered as an invalid input (TOU function will be disabled).
2. TOU season format: Enter the start date into the TOU season table slot following this format "MM-DD ID" - MM stands for the month, DD stands for the day and ID stands for the TOU schedule ID (available from 01 to 14). The dates should be organized so that they are in sequence according to the calendar

year (the earlier date comes first and the later date comes last). For example, if 3 seasons are selected, the date parameters are January 1, June 6 and September 7, and TOU schedule 02, 01, 03 will be used respectively, the first TOU season table slot shall enter 01-01 02, the second slot shall enter 06-06 01, and the third slot shall enter 09-07 03. Entering 01-01 02 for the first slot, 09-07 03 for the second slot and 06-06 01 for the third slot is considered invalid.

3. Schedule setting parameter: The number of available TOU schedules depends on the schedule setting parameter. The parameter can be selected from any integer between 1 to 14. This parameter determines the number of TOU schedules available for the TOU calendar setting. A maximum of 14 TOU schedules (from TOU Schedule #1 to TOU Schedule #14) can be used.

4. Segment setting parameter: Each TOU schedule consists of various timing segments. The number of segments depends on the segment setting parameter setup. The parameter can be selected from any integer between 1 to 14 (inclusively). User must enter the correct value for the segment setting parameter in accordance to the TOU schedule table. If the segment setting parameter is set as 3, the first 3 slots of the TOU schedule table must be set, otherwise, it will be considered as an invalid input (TOU function will be disabled).

5. TOU schedule format: Each TOU schedule represents a 24 hour cycle. Similar to TOU season format, enter the start time into the TOU schedule table slot following this format "HH:MM ID" - HH stands for hour (in 24 hr format), MM stands for minutes and ID stands for tariffs (available from 00 to 03). The time should be organized according to the hour sequence. For example, if 3 segments are selected, timing parameters are 01:00, 15:30, 22:45, the order of the 3 segments should be one of the following: 01:00, 15:30, 22:45 or 15:30, 22:45, 01:00 or 22:45, 01:00, 15:30 Entering time information in a wrong sequence (for example, entering 15:30, 01:00, 22:45) is considered as an invalid

operation, TOU function will be disabled.

6. Tariff setting parameter: This parameter corresponds to the number of tariffs available for the TOU calendar and can be selected from any integer from 0 to 3. The four tariffs: sharp, peak, valley and normal are represented by 4 integers: 0, 1, 2 and 3 respectively. If the tariff setting parameter is set to 3, all of the 4 tariffs will be available for the TOU calendar; if the parameter is set to 1, only the first 2 tariffs (sharp and peak) will be available.

7. Holiday setting parameter: This parameter can be set from any integer between 1 and 30, meaning a maximum of 30 holidays can be programmed to the TOU calendar. If the holiday setting parameter is set to 3, the first 3 slots of the holiday schedule must be set, otherwise it will be considered as an invalid input (TOU function will be disabled).

Note: User can either customize the TOU calendar factory settings or use the default factory settings. User can reset the TOU calendar to its default value either via communication or from the meter front.

8. Holiday schedule: The holiday schedule uses the same format as the TOU seasons “MM-DD ID”. User can select which TOU schedule to be used for the holiday. The dates of the holiday schedule do not need to be organized in a sequential order (i.e. the first slot can be January 1, the second slot can be December 26 and the third slot can be December 25).

9. Daylight saving time (DST): Daylight saving time can be enabled in one of two formats: The fixed date option, or a fixed day of one of the weeks in the month (also named as the non-fixed date option). if you choose a fixed date option, you set the format according to a fixed date, for the daylight saving time switch: the format month / day / hour / minute / adjust time (in minutes). If you choose non-fixed date option, DST will be implemented by which day of which week, whose setting format is month/which day (i. e. Tuesday)/which week (i. e. 1st

week)/hour/minute/adjust time(in minutes).

By using the function, you can cause the instrument to automatically switch to and from daylight saving time. When the clock starts to run to daylight saving time, the meter will automatically adjust the clock to a time period in advance, while the clock is running to the end of daylight saving time, meter will automatically adjust the clock pushed back to a time period, as shown in Fig 4-10

Daylight Saving Time

DST Enable DST Format: Format 1

Format 1

DST Start: Apr 1 Day 12 Hour 25 Min Adjust Time: 5 Minutes

DST Ending: Jul 2 Day 0 Hour 12 Min Adjust Time: 45 Minutes

Format 2

DST Start: Mar 2nd Thu at 11 : 23 Adjust Time: 2 Minutes

DST Ending: Apr 2nd Sun at 23 : 35 Adjust Time: 60 Minutes

Fig 4-10 Daylight saving time setting interface

10. Ten-year Holiday setting

Users can preset holidays of the next decade via the meter software. The holiday format is month/day/year; holiday code; holiday schedule. After the format setup, click on "Make Holiday Settings (10 year)", then a holiday table for the next decade will be generated.

Holiday Auto Switch: When Ten-year Holiday is enabled, if the current year of the meter falls into the Ten-year Holiday setting, it automatically loads the Ten-year Holiday settings into the current TOU settings. If the current year of the meter does not fall into the Ten-year Holiday setting, it remains the current TOU settings.

Enable Holidays Years Settings

Start Year Ending Year

1st Year Holidays

1	01-01 1	02-01 2	03-01 3	04-01 4	05-01 5	00-00 00	6
7	00-00 00	00-00 00	00-00 00	00-00 00	00-00 00	00-00 00	12
13	00-00 00	00-00 00	00-00 00	00-00 00	00-00 00	00-00 00	18
19	00-00 00	00-00 00	00-00 00	00-00 00	00-00 00	00-00 00	24
25	00-00 00	00-00 00	00-00 00	00-00 00	00-00 00	00-00 00	30

Settings Year Holiday Number

2nd Year Holidays

1	01-01 1	02-01 2	03-01 3	04-01 4	05-01 5	06-01 6	6
7	07-01 7	08-01 8	09-01 9	10-01 10	00-00 00	00-00 00	12
13	00-00 00	00-00 00	00-00 00	00-00 00	00-00 00	00-00 00	18
19	00-00 00	00-00 00	00-00 00	00-00 00	00-00 00	00-00 00	24
25	00-00 00	00-00 00	00-00 00	00-00 00	00-00 00	00-00 00	30

Fig 4-11 ten years holiday table

11. Weekend Schedule: Weekend Setting (bit0 : Sunday; bit1 ~ bit6: Monday to Saturday; bit 0 means not effective, bit 1 means effective). For example, when the Weekend Setting bit0 is 1, it means Sunday is effective. When the Weekend Setting bit1 is 1, it means Monday is effective. For example, if a user wants to set Saturday and Sunday effective, he should put 65 (100001) into the Weekend

Setting field. When the meter clock is within the preset Weekend Schedule, the energy will accumulate under the tariff that corresponds to the Schedule.

Note: Holiday schedule has the highest priority among all the schedules. Weekend schedule's priority is followed by Holiday schedule. When Holiday schedule is not enabled, Weekend schedule has the highest priority, overriding the normal (weekday) schedule.

Acuvim IIE can record maximum power and current demand under different tariffs, as well as the time stamp of the maximum value. It can also clear the maximum demand under different tariffs.

Except normal energy parameter readings, Acuvim IIE has 4 separate logs: Current Accumulation Month TOU, Prior Accumulation Month TOU, Current Month TOU and Prior Month TOU. When setup appropriately and when TOU is enabled, energy will be accumulated on a month-to-month basis. The current energy usage will be stored under Current Month TOU (or Current Accumulation Month TOU) and is divided up into different tariffs. When next month (or counting period) starts, all Current Month TOU values will be moved to Prior Month TOU (or Prior Accumulation Month TOU).

There are two ways of automatic resetting of current month TOU.

1. End of Month: This is the default method. All values from Current Accumulation Month TOU will be copied over to Prior Accumulation Month TOU at the very beginning of each month (the first day of each month at time 00:00:00). Current Accumulation Month TOU will continue to accumulate. All values from Current Month TOU will be copied over to Prior Month TOU at the very beginning of each month (the first day of each month at time 00:00:00) be cleared and reset to 0.
2. Assigned Clock: User can select when the values from Current Accumulation Month TOU or Current Month TOU would be copied over to Prior Accumulation

Month TOU or Prior Month TOU. User can set the time in the following format :DD HH:MM:SS"-DD stands for day, HH stands for hour, MM stands for minute, SS stands for second. Similar to the previous method, once Current Accumulation Month TOU is transferred to Prior Accumulation Month TOU, Current Accumulation Month TOU will continue to accumulate. Once Current Month TOU is transferred to Prior Month TOU, Current Month TOU will be cleared and reset to 0.

4.7 Power Quality Event Logging and Waveform Capture

Power Quality Event Logging

When a power quality event happens, such as voltage sag and swell, Acuvim I IW will record the event timestamp and the triggering condition. It can save up to 50,000 events.

1. Event Logging Data format

Timestamp (4 words) + Triggering Condition (1 word) + Rated Value (1 word) + Threshold (1 word) + Half Cycle Count (1 word)

Each event has 8 words in total.

Event Time: W1: Year—High Byte; Month—Low Byte; W2: Day—High Byte, Hour—Low Byte; W3: Minute—High Byte; Second—Low Byte; W4: Millisecond

Triggering Condition: W5—Voltage Sags or Voltage Swells 0: logging disabled;

Bit0: 1 – u1 voltage sag, 0 – no u1 voltage sag;

Bit1: 1 – u2 voltage sag, 0 – no u2 voltage sag;

Bit2: 1 – u3 voltage sag, 0 – no u3 voltage sag;

Bit3: 1 – u1 voltage swell, 0 – u1 no voltage swell;

Bit4: 1 – u2 voltage swell, 0 – u2 no voltage swell;

Bit5: 1 – u3 voltage swell, 0 – u3 no voltage swell;

Rated Value: W6—Voltage rated value;

Threshold: W7—Threshold for voltage sag and swell.

Half Cycle count: W8 (Voltage Swell: 0; Voltage Sag: 4~200)

2. Logging Events

The event logging feature can log 50000 events. If the 50000 events are full, no more events will be logged even if the triggering condition happens. The user must clear the event log, and then the logging will log the new event. When the log is cleared, the new event will be logged from the first event happening. There will be no data loss after the power is off.

3. Event Logging Triggering Conditions

1) Voltage Sag

When any phase of the three phase voltage is lower than the set value (voltage rated value x threshold %), there will be a voltage sag event. When one phase voltage sag happens, the other phase will not respond to voltage sag event logging. Only when all of the phases voltage restore back to normal, a new voltage sag event will be responded.

2) Voltage Swell

When any phase of the three phase voltage is higher than the set value (voltage rated value x threshold %), there will be an Voltage Swell event. When one phase Voltage Swell happens, the other phase will not respond to Voltage Swell event logging. Only when all of the phases voltage restore back to normal, a new Voltage Swell event will be responded.

Note:

The following figure depicts how to set the parameters for Power Quality Event Logging and Waveform Capture. In the parameter settings, Voltage Sag and Voltage Swell share the same voltage rated value. The parameters for event logging includes: voltage rated value, voltage sag threshold, voltage sag half cycle count and voltage swell threshold. Those parameters also fit voltage sag

waveform capture. The other triggering conditions for Waveform Capture can be set when necessary. When the Waveform Capture triggering by Voltage Sag and Voltage Swell is enabled, the corresponding event log and waveform will be recorded when Voltage Sag or Voltage Swell happens.

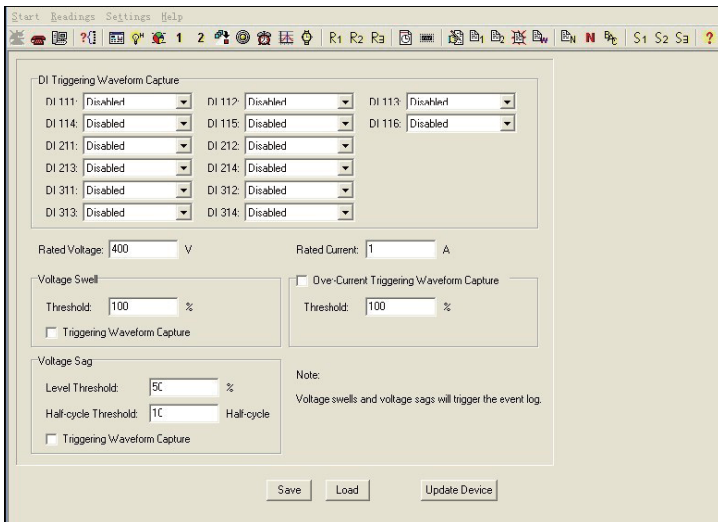

Fig. 4-12

4. Event Log Retrieve

When a new event log commences, the newest event number address(0X8CFDH)contains the newest event number. When the log is being retrieved, the starting event log number (0X8CFEH) and the event quantity for

each retrieve (0X8CFF) must be set correctly. It must be ensured that the starting number of event log should equal or smaller than the newest log number. When setup is correct, reading registers 0X8D00H—0X8D4FH will acquire the event log data. Each time a maximum of 10 logged events can be retrieved. The event log retrieve page is in the figure below. The Modbus register address of the event log is in the table below (see details in Chapter 6).

8CFDH	The newest event number	word	R	Range: 1~50000 0: No event
8CFEH	The starting event log number	word	R/W	Range: 1-50000 Note: smaller than or equal to the newest event number.
8CFFH	The event quantity of each time retrieve	word	R/W	1-10

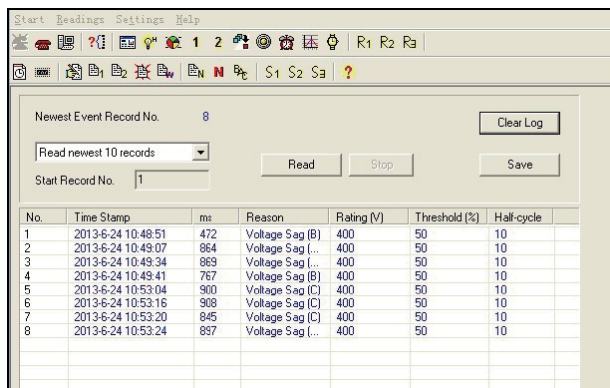

Fig. 4-13

Waveform Capture

Acuwin IIW can record 100 groups of voltage and current waveform data at a sampling rate of 64 points per cycle. It provides the captured waveform of 10 cycles before and after the triggering point (including U1,U2,U3,I1,I2,I3). The triggering condition is settable.

1. Waveform Capture Data Format

Timestamp(7 words)+ Triggering Condition(9 words)+ Kept Data Storage(48 words)+ U1, U2, U3, I1, I2, I3(Before triggering point 10 waveforms 64 x 10 x 6 words)+ U1, U2, U3, I1, I2, I3(After triggering point 10 waveforms 64x10x6 words).

Timestamp: Year(W1), Month(W2), Day(W3), Hour(W4), Minute(W5), Second(W6), Millisecond(W7)

Triggering Condition:

W8—Manual Triggering (0: disable; 1: enable);

W9— AXM-11 DI Triggering (bit1bit0: DI1(bit3bit2: DI2)bit5bit4: DI3; bit7bit6: DI4; bit9bit8: DI5; bit11bit10: DI6);

W10—AXM-21 DI Triggering (bit1bit0: DI7; bit3bit2 : DI8; bit5bit4: DI9; bit7bit6: DI10);

W11—AXM-31 DI Triggering (bit1bit0: DI11; bit3bit2 : DI12; bit5bit4: DI13; bit7bit6: DI14);

(Two bits meaning: 00: No DI Triggering; 01: DI Triggering from OFF to ON; 10: DI Triggering From On to OFF)

W12— Voltage Sag Triggering (0: disabled;

Bit0: 1 – u1 voltage sag waveform, 0 – no u1 waveform;

Bit1: 1 – u2 voltage sag waveform, 0 – no u2 waveform;

Bit2: 1 – u3 voltage sag waveform, 0 – no u3 waveform)

W13— Voltage Swell Triggering (0: disabled;

Bit0: 1 – u1 voltage swell waveform, 0 – no u1 waveform;

Bit1: 1 – u2 voltage swell waveform, 0 – no u2 waveform;

Bit2: 1 – u3 voltage swell waveform, 0 – no u3 waveform;)

W14— Over-current Triggering (0: disabled;

Bit0: 1 – I1 voltage over-current waveform, 0 – no I1 waveform;

Bit1: 1 – I2 voltage over-current waveform, 0 – no I2 waveform;

Bit2: 1 – I3 voltage over-current waveform, 0 – no I3 waveform;)

W15,W16----0 (Reserved)

Waveform Order:

Before triggering point 10 U1 waveforms, 10 U2 waveforms, 10 U3 waveforms, 10 I1 waveforms, 10 I2 waveforms, 10 I3 waveforms.

After triggering point 10 U1 waveforms, 10 U2 waveforms, 10 U3 waveforms, 10 I1 waveforms, 10 I2 waveforms, 10 I3 waveforms.

2. Waveform Capture Group

Waveform Capture can log up to 100 groups of waveform data. When the 100 group data is full, it does not respond to any waveform triggering condition. Only when all the waveform data is reset / emptied, waveform capturing function will be normal. When the waveform data is emptied, new waveform data starts from the 1st group. The waveform data will not be lost when the power is off.

Note: since the amount of each waveform group data is large, it takes more time to write into the flash memory. Therefore, Waveform Capture only responds to one triggering condition at one time. During the process of writing data into the flash memory, it does not respond to new triggering condition. After

the process of memory writing, it will respond to new waveform triggering condition.

3. Waveform Capture Triggering Condition

1) Manual Triggering

Manually trigger one group waveform capture.

2) DI Triggering

DI Triggering must fulfill the following two conditions at the same time.

- IO modules with the logical address of 1 (AXM-IO11, AXM-IO21, AXM-IO31).
- DI channel type is set as "State".

The Modbus address assigns two bits for the DI channel. When they are set as "00", it means DI Triggering Disabled; "01" means DI Triggering will be implemented when DI state changes from OFF to ON; "10" means DI Triggering will be implemented when DI state changes from ON to OFF; "11" means DI Triggering will be implemented when DI state has any change.

3) Voltage Sag Triggering

As mentioned in Voltage Sag event logging, when Voltage Sag Triggering Waveform is enabled, both event logging and waveform capture will be implemented at the same time once a voltage sag happens.

4) Voltage Swell Triggering

As mentioned in Voltage Swell event logging, when Voltage Swell Triggering Waveform is enabled, both event logging and waveform capture will be implemented at the same time once a voltage swell happens.

5) Over-current Triggering

When Over-current Triggering is enabled, if any phase of the three phase current is higher than the set value (rated value x threshold %), the waveform

capture will be implemented. If one phase is over-current, any other phase over-current cannot implement the waveform capture. Only when all of the phase current restore back to normal, waveform capture will be responding.

4. Waveform Capture Retrieve

Because of large quantity of saved waveform, waveform retrieving window use 64 addresses to make retrieving data easier, which keeps consistent with recording points of one period. There are two retrieving methods, one retrieve waveform record reasons, another retrieve all data of one group waveform. Two methods are shown below.

First retrieving method is only retrieving waveform record reasons.

When 0x8E01H (Waveform Group Number) is set to 0, waveform record reason can be retrieved from data retrieving window, by changing Waveform Group Number for Retrieving (8E00H). Waveform record reason is 16 bytes and data window are 64 bytes, so that is the reason why each retrieving access include 4 group records.

For example, if the total number of Waveform Group Number for Retrieving is 19, the by this method, only through 5 times retrieving, all 20 groups waveform can be retrieved. Before retrieving, user should write 0 to 8E01H, and 1 to 8E00H, while at first time retrieving addresses from 8E00 to 8E43, these window data are the reasons of waveform group 1, 2, 3, 4. After retrieving, Waveform Group Number for Retrieving (8E00H) will automatically update to 5. While at second time retrieving addresses from 8E00 to 8E43, these window data are the reasons of waveform group 5, 6, 7, 8. Waveform Group Number for Retrieving (8E00H) will stop increasing after the value reaches 17.

Note: Unless user retrieves all data from 8E00H to 8E43H in one time, Waveform Group Number for Retrieving (8E00H) will automatically add 4, otherwise Waveform Group Number for Retrieving (8E00H) will keep present value if only

retrieving partial data. Waveform Group Number for Retrieving (8E00H) will stop increasing while value reaches Newest Waveform Group Number. If the value added 4, the value will be larger than Newest Waveform Group Number.

Second retrieving method is retrieving all waveforms data. When 0x8E01H (Waveform Group Number) is set to 1~121, each time only one group data of each number will be retrieved, then Waveform Group Number for Retrieving (8E01H) will automatically add 1 after retrieving. At next time, new Waveform Group Number will be retrieved. Waveform Group Number will stop increasing after value reach 121.

Note: The range of 0x8E01H is 0~121, within setting range, windows (8E04H~8E43H) are corresponding to waveform data.

0: Only retrieving waveform record reasons

1: Time and reasons of waveforms

2~11: Each waveform number of ten waveforms before U1 waveform is triggered

12~21: Each waveform number of ten waveforms before U2 waveform is triggered

22~31: Each waveform number of ten waveforms before U3 waveform is triggered

32~41: Each waveform number of ten waveforms before I1 waveform is triggered

42~51: Each waveform number of ten waveforms before I2 waveform is triggered

52~61: Each waveform number of ten waveforms before I3 waveform is triggered

62~71: Each waveform number of ten waveforms after U1 waveform is triggered

72~81: Each waveform number of ten waveforms after U2 waveform is triggered

82~91: Each waveform number of ten waveforms after U3 waveform is triggered

92~101: Each waveform number of ten waveforms after I1 waveform is triggered

102~111: Each waveform number of ten waveforms after I2 waveform is triggered

112~121: Each waveform number of ten waveforms after I3 waveform is triggered

Note: Unless user retrieves all data from 8E00H to 8E43H in one time, Waveform Group Number for Retrieving (8E01H) will automatically add 1, or Waveform Group Number for Retrieving (8E01H) will keep present value if only retrieving partial data.

8E00H		Waveform Group Number for Retrieving	1~100 Note: When the value is smaller than or equal to newest waveform record group number, this value is valid.
8E01H		Waveform Group Number	Waveform number 0~121
8E02H		Waveform record window status	0x0BH: window data is valid. 0xFF: window data is invalid. 0xAA: waveform record memory is clearing(data is invalid)
8E03H		Newest Waveform Group Number	1~100 0~no record
8E04H- 8E43H	-----	Waveform record data retrieving window	-32768~ 32767

5. Relationship between voltage or current waveform value and real value

The relationship between voltage waveform value and real value:

$$\text{Real Value (Unit: V)} = \text{Waveform Value} / 37.59105$$

The relationship between current waveform value and real value:

- 1)5A,1A: Real Value(Unit: A) = Waveform Value/1683.153;
 2)333mV: Real Value(Unit: A) = Waveform Value/K (firmware above 3.21,K=14427.15; other: K = 15869.87);
 3)100mV(Rope-CT):Real Value(Unit: A) = Waveform Value/K (firmware above 3.21,K=20291.1; firmware 3.20, K=22068.8,other: K = 15869.87);
 4)mA CT:Real Value(Unit: A) = Waveform Value/K (80mA CT:K=7414.289; 100mA:K=9267.440; 200mA:K=18514.68);The voltage and current value obtained from the waveform are the PT or CT secondary side value.
 The waveform capture retrieve page is shown in Fig 4-14.

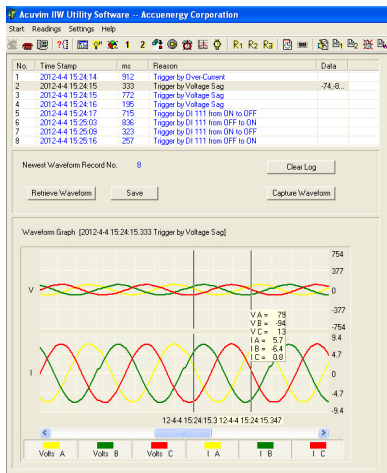

Fig. 4-14

Note: When selecting 400Hz type, not support event logging and wave capture.

4.8 Seal Function

The panel with seal, which has sealed key control, is different with one without seal. When the seal is in opened status, functions are same like normal meters. But when the seal is in sealed status, some functions of meters, which include parameters blocked by seal and optional parameters, will be blocked. These parameters can still be accessible by keys and communication way if they can be accessed before, but in sealed status, these parameters cannot be modified by keys or communication way any more.

Addresses about seal function are 101EH and 101FH.

Address 101EH is about parameters blocked by seal, which can be configured by users. These setting will be valid only when seal is in sealed status.

Address 101FH is about if seal function is valid. When the panel is normal one, or the seal panel is in invalid sealed status, this address will show seal is open. When the seal is valid, this address will show sealed status and corresponding parameters will be blocked.

101EH	Sealed Nonstandard Parameters Selection	Bit0: 1st communication parameters Bit1: 2nd communication parameters Bit2: run time clear Bit3: DI pulse count Bit4: TOU 1: valid of corresponding selection 0: invalid
101FH	Seals status	0x0A: Seal sealed; Other: Seal opened.

Parameters blocked by seal .

As long as seal is in sealed status, parameters below must be blocked, no matter what value of address 101EH.

System parameters setting:

Address	Parameter	Keys	Communication
1003H	Voltage input wiring type	√	√
1004H	Current input wiring type	√	√
1005H	PT1(High 16 bit)	√	√
1006H	PT1(Low 16 bit)	√	√
1007H	PT2	√	√
1008H	CT1	√	√
1009H	CT2	√	√
100AH	kWh pulse constant	√	√
100BH	Kvarh pulse constant	√	√
100DH	Demand slid window time	√	√
100EH	Demand calculating mode	√	√
100FH	Clear demand memory	√	√
1012H	Current I1 direction	√	√
1013H	Current I2 direction	√	√
1014H	Current I3 direction	√	√
1015H	VAR/PF convention	√	√
1016H	Energy clear	√	√
1017H	Energy calculating mode	√	√
1018H	Reactive power measuring mode	√	√
1019H	Energy display mode	√	√
101DH	Basic parameter mode	√	√
101EH	Sealed Nonstandard Parameters Selection	-	√

Note: "√"/" means these addresses will be blocked for keys and communication, and "-" means this function is unavailable.

Energy:

Address	Parameter	Keys	Communication
4048H~4049H	Energy IMP	-	√
404AH~404BH	Energy EXP	-	√
404CH~404DH	Reactive energy IMP	-	√
404EH~404FH	Reactive energy EXP	-	√
4050H~4051H	Energy TOTAL	-	√
4052H~4053H	Energy NET	-	√
4054H~4055H	Reactive energy TOTAL	-	√
4056H~4057H	Reactive energy NET	-	√
4058H~4059H	Apparent energy	-	√
4620H~4621H	Phase A Energy IMP	-	√
4622H~4623H	Phase A Energy EXP	-	√
4624H~4625H	Phase B Energy IMP	-	√
4626H~4627H	Phase B Energy EXP	-	√
4628H~4629H	Phase C Energy IMP	-	√
462AH~462BH	Phase C Energy EXP	-	√
462CH~462DH	Phase A Reactive energy IMP	-	√
462EH~462FH	Phase A Reactive energy EXP	-	√
4630H~4631H	Phase B Reactive energy IMP	-	√
4632H~4633H	Phase B Reactive energy EXP	-	√
4634H~4635H	Phase C Reactive energy IMP	-	√
4636H~4637H	Phase C Reactive energy EXP	-	√
4638H~4639H	Phase A Apparent energy	-	√
463AH~463BH	Phase B Apparent energy	-	√
463CH~463DH	Phase C Apparent energy	-	√

DO:

Address	Parameter	Keys	Communication
10A5H	Working mode of DO 1 and 2	√	√
10A6H	DO pulse width	√	√
10A7H	DO1 output	√	√
10A8H	DO2 output	√	√
10B7H	Working mode of DO 3 and 4	√	√
10B8H	DO pulse width	√	√
10B9H	DO3 output	√	√

10BAH	DO4 output	√	√
-------	------------	---	---

Sealed Nonstandard Parameters:

1) When bit 0 of address 101EH is valid, parameters about 1st communication should be blocked.

Address	Parameter	Keys	Communication
0FFEh	Communication Protocol 1	√	√
0FFFh	Parity Setting 1	√	√
1000h	Password	√	√
1001h	Communication address 1	√	√
1002h	Baud rate 1	√	√

2) When bit 1 of address 101EH is valid, parameters about 2nd communication should be blocked.

Address	Parameter	Keys	Communication
102FH	Baud rate2	√	√
1030H	Parity Setting 2	√	√
1031H	Communication address 2	√	√
Ethernet Module			
	DHCP setting	√	√
	IP address 1 st byte (high)	√	√
	IP address 2 nd byte (low)	√	√
	IP address 3 rd byte (high)	√	√
	IP address 4 th byte (low)	√	√
	Submask 1 st byte (high)	√	√
	Submask 2 nd byte (low)	√	√
	Submask 3 rd byte (high)	√	√
	Submask 4 th byte (low)	√	√
	Gateway 1 st byte (high)	√	√
	Gateway 2 nd byte (low)	√	√
	Gateway 3 rd byte (high)	√	√
	Gateway 4 th byte (low)	√	√
	DNS1 1 st byte (high)	√	√
	DNS1 2 nd byte (low)	√	√
	DNS1 3 rd byte (high)	√	√

	DNS1 4 th byte (low)	√	√
	DNS2 1 st byte (high)	√	√
	DNS2 2 nd byte (low)	√	√
	DNS2 3 rd byte (high)	√	√
	DNS2 4 th byte (low)	√	√
	Modbus Tcp/Ip port	√	√
	Http port	√	√
BACnet Module			
	BACnet module enable	√	√
	DHCP setting	√	√
	IP address 1 st byte (high)	√	√
	IP address 2 nd byte (low)	√	√
	IP address 3 rd byte (high)	√	√
	IP address 4 th byte (low)	√	√
	Submask 1 st byte (high)	√	√
	Submask 2 nd byte (low)	√	√
	Submask 3 rd byte (high)	√	√
	Submask 4 th byte (low)	√	√
	Gateway 1 st byte (high)	√	√
	Gateway 2 nd byte (low)	√	√
	Gateway 3 rd byte (high)	√	√
	Gateway 4 th byte (low)	√	√
	DNS1 1 st byte (high)	√	√
	DNS1 2 nd byte (low)	√	√
	DNS1 3 rd byte (high)	√	√
	DNS1 4 th byte (low)	√	√
	DNS2 1 st byte (high)	√	√
	DNS2 2 nd byte (low)	√	√
	DNS2 3 rd byte (high)	√	√
	DNS2 4 th byte (low)	√	√
	MAC address	√	√
	BACnet baud rate	√	√
	Max info frames	√	√
	BACnet Port	√	√
PROFIBUS Module			
	PROFIBUS address	√	-

3) When bit 2 of address 101EH is valid, parameters below should be blocked.

Address	Parameter	Keys	Communication
1011H	Run time clear	√	√

4) When bit 3 of address 101EH is valid, parameters below should be blocked.

Address	Parameter	Keys	Communication
101CH	Pulse counter clear	√	√
109EH	DI1-6 type	√	√
109FH	DI pulse constant	√	√
10A3H	DI7-10 type	√	√
10A4H	DI pulse constant	√	√
10AAH	DI11-14 type	√	√
10ABH	DI pulse constant	√	√
10B0H	DI15-20 type	√	√
10B1H	DI pulse constant	√	√
10B5H	DI21-24 type	√	√
10B6H	DI pulse constant	√	√
10BCH	DI25-28 type	√	√
10BDH	DI pulse constant	√	√

5) When bit 4 of address 101EH is valid, parameters below should be blocked.

Address	Parameter	Keys	Communication
103FH	Week	-	√
1040H	Year	-	√
1041H	Month	-	√
1042H	Day	-	√
1043H	Hour	-	√
1044H	Minute	-	√
1045H	Second	-	√

Note: Standard time is valid within ± 5 minutes, it will be invalid if not in this range.

Address	Parameter	Keys	Communication
TOU			
1039H	Ten years download setting enable	-	√
103AH	Fee of sharp demand clear	-	√
103BH	Fee of peak demand clear	-	√
103CH	Fee of valley demand clear	-	√
103DH	Fee of normal demand clear	-	√
103EH	Total fee of demand clear	-	√
Current and last month TOU energy			
7200H-7263H	Current and last month TOU energy	-	√
DST setting			
7700H-7717H	DST setting	-	√
Season setting			
7800H-780EH	Basis parameter of TOU	-	√
7820H-7AECH	Season setting	-	√
Ten years holiday setting			
7B00H-7E97H	Ten years holiday setting	-	√

Chapter 5 Extended Modules

5.1 IO Modules

5.2 Ethernet Module (AXM-NET)

5.3 ProfiBus Module (AXM-PRO)

5.4 RS485 Module (AXM-485)

5.5 BACnet Module (AXM-BACnet)

5.1 IO Modules

5.1.1 The Purpose of IO Modules

The standard Acuvim II meter base does not have any built-in IO functions. However, with the addition of the extended modules, multiple IO options can be added. These functions include digital input, pulse counter, relay output, analog output, analog input, etc.

There are three types of IO modules, AXM-IO1, AXM-IO2 and AXM-IO3. Please note that a maximum of 3 modules may be attached to the meter. If a communication module is used, it must be installed on the back of the meter first before any IO modules are attached. No more than 2 of the same type IO modules can be attached. According to the difference in communication with Acuvim II meter, each type of IO module also has two modes, logic NO.1 and logic NO.2. This means, two of each type of IO module can be linked to the Acuvim II meter simultaneously (one being logic NO.1 and the other being logic NO.2).

The AXM-IO1 module is composed of:

6 digital inputs (DI) -- Each digital input can be used to detect remote signals, or be used as an input pulse counter. When it is used to detect remote signals, it also can enable SOE(sequence of events), recording the event and time of the event.

2 relay outputs (RO) -- Can be used for controlling or alarming. Each of the relay outputs work in the same mode. When it operates in controlling mode, there are two output options; latching and pulse. When it operates in alarm mode, it has only one latching output mode.

24V isolated power supply -- Used as an auxiliary power supply for digital inputs.

The AXM-IO2 module is composed of:

4 digital inputs (DI) -- Each digital input can be used to detect remote signals, or be used as an input pulse counter. When it is used to detect remote signals it can also enable SOE(sequence of events), recording the events and time of the events.

2 analog outputs (AO) -- Can output analog voltage or analog current. When it outputs analog voltage, the range of voltage is from 0 to 5V or from 1 to 5V. When it outputs analog current, the range of current is from 0 to 20mA or from 4 to 20mA.

2 digital outputs (DO) -- Can be used in alarm mode or energy pulse output mode. Both of the digital outputs work in the same mode. When it operates in energy pulse output mode, it can output various types of energy.

The AXM-IO3 module is composed of:

4 digital inputs (DI) -- Each digital input can be used to detect remote signals, or be used as an input pulse counter. When it is used to detect remote signals it can also enable SOE(sequence of events), recording the events and time of the events.

2 relay outputs (RO) -- Can be used for controlling or alarming. Each of the relay outputs work in the same mode. When it operates in controlling mode, there are two output options; latching mode and pulse. When it operates in alarm mode, it has only one latching output mode.

2 analog inputs (AI) -- Can detect input analog voltage or analog current. When it detects input analog voltage, the range of voltage is from 0 to 5V or from 1 to 5V. When it detects input analog current, the range of current is from 0 to 20mA or from 4 to 20mA.

5.1.2 List of Functions of IO Modules

Table 5-1

Functions	AXM-IO1	AXM-IO2	AXM-IO3
Detection of remote signals	•	•	•
Recording of SOE	•	•	•
Counting of input pulses	•	•	•
Output remote controlling by relay	•		•
Output alarm by relay	•		•
Output alarm by digital output		•	
Output power pulses by digital output		•	
Analog output		•	
Analog input			•
24V isolated voltage output	•		

5.1.3 Appearance and Dimensions

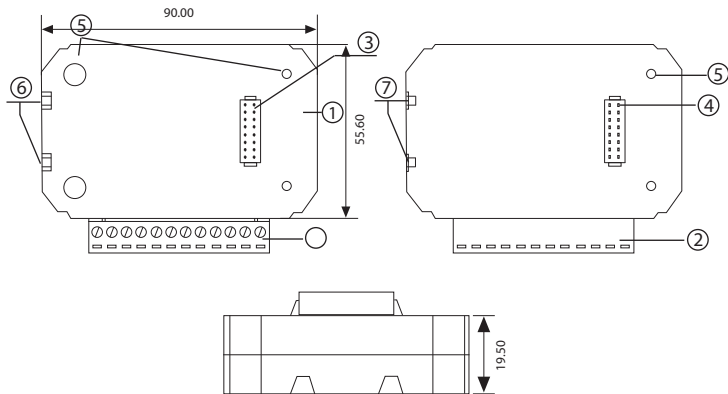

①	Enclosure	⑤	Installation screw
②	Wiring Terminals	⑥	Counterpart of clip
③	Linking pins	⑦	Installation clip
④	Linking socket		

Fig 5-1 Dimensions

5.1.4 Installation Method

Environment

Please verify the installation environment meets the requirements listed as follows:

Temperature

Operation: -25°C to 70°C

Storage: -40°C to 85°C

Humidity

5% to 95% non-condensing.

Location

The Acuvim II meter and IO modules should be installed in a dry and dust free environment avoiding heat, radiation and high electrical noise sources.

Installation Method

With the link pins, IO modules are linked to the meter and to each other. The maximum number of extended modules linked to Acuvim II meter, including IO module, Ethernet module Profibus module, RS-485 module and BACnet module, is three. The communication modules must be installed first. No other module can be installed before them.

1. Insert the installation clips to the counterpart of Acuvim II meter, and then

press the IO module lightly, so linking is established.

2. Tighten the installation screws.
3. Install other IO modules the same way.

Note: 1. Install IO Modules carefully to avoid damage;
2. Under no circumstances should any installation be done with the meter powered on. Failure to do so may result in injury or death.

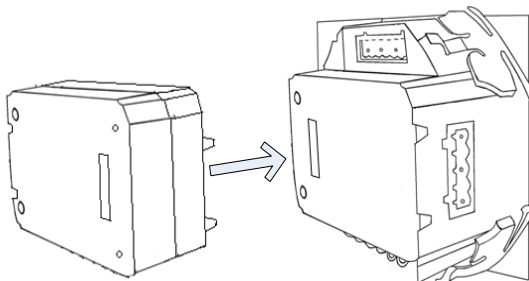

Fig 5-2 Installation of IO modules

5.1.5 Wiring of IO Modules

Terminal strips of AXM-IO1 module

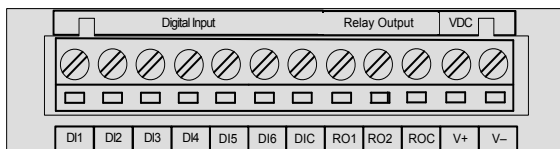

Fig 5-3 Terminal strips of AXM-IO1 module

DI1 to DIC: digital input terminals, where DIC is the common terminal for DI1 to DI6 circuits.

RO1 to ROC: relay output terminals, where ROC is the common terminal for RO1 and RO2 circuits.

V24+ and V24-: auxiliary voltage supply terminals.

Terminal Strips of AXM-IO2 Module:

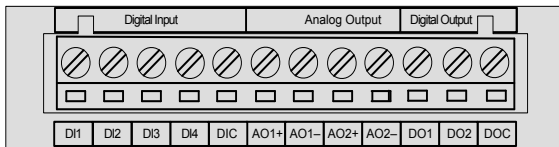

Fig 5-4 Terminal strips of AXM-IO2 module

DI1 to DIC: digital input terminals, where DIC is the common terminal for DI1 to DI4 circuits.

AO1+, AO1-, AO2+, AO2-: analog output terminals.

DO1 to DOC: digital output terminals, where DOC is the common terminals for DO1 to DO2.

Terminals strips of AXM-IO3 module:

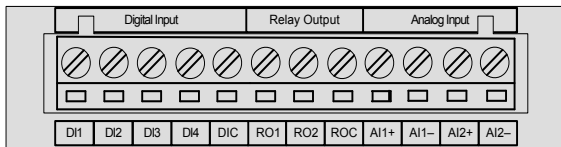

Fig 5-5 Terminal strips of AXM-IO3 module

DI1 to DIC: digital input terminals, where DIC is the common terminal for DI1 to DI4 circuits.

RO1 to ROC: relay output terminals, where ROC is the common terminal for RO1 and RO2 circuits.

AI1+, AI1-, AI2+, AI2-: analog input terminals.

Sequence of DI, RO, DO, AO, AI in IO modules (according to the logical order in the communication address table of the main body):

DI Sequence: AXM-IO11 (AXM-IO1 module in logic NO.1): DI1-6

AXM-IO21 (AXM-IO2 module in logic NO.1): DI7-10

AXM-IO31 (AXM-IO3 module in logic NO.1): DI11-14

AXM-IO12 (AXM-IO1 module in logic NO.2): DI15-20

AXM-IO22 (AXM-IO2 module in logic NO.2): DI21-24

AXM-IO32 (AXM-IO3 module in logic NO.2): DI25-28

RO Sequence: AXM-IO11 (AXM-IO1 module in logic NO.1): RO1-2

AXM-IO31 (AXM-IO3 module in logic NO.1): RO3-4

AXM-IO12 (AXM-IO1 module in logic NO.2): RO5-6

AXM-IO32 (AXM-IO3 module in logic NO.2): RO7-8

DO Sequence: AXM-IO21 (AXM-IO2 module in logic NO.1): DO1-2

AXM-IO22 (AXM-IO2 module in logic NO.2): DO3-4

AO Sequence: AXM-IO21 (AXM-IO2 module in logic NO.1): AO1-2

AXM-IO22 (AXM-IO2 module in logic NO.2): AO3-4

AI Sequence: AXM-IO31 (AXM-IO3 module logic NO.1): AI1-2

AXM-IO32 (AXM-IO3 module in logic NO.2): AI3-4

Wiring of Digital Input Circuit:

There are 6 digital input circuits, 4 digital input circuits and 4 digital input circuits in AXM-IO1, AXM-IO2 and AXM-IO3 modules respectively. The digital input circuit can be used to detect remote signals, or be used as an input pulse counter.

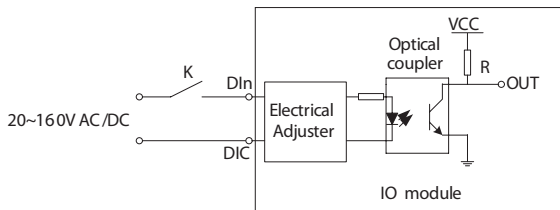

Fig 5-6 schematic diagram of digital input circuit

The circuit drawing of digital input is simplified as shown in Fig 5-6. When K is switched off, OUT is in high state. When K is switched on, OUT is in low state.

The external power supply for the digital input is 20-160 Vad/Vdc. The max current in the loop line is 2mA.

The wire of digital input should be chosen between AWG22~16 or 0.5~ 1.3mm².

Wiring of Relay Output Circuit:

There are 2 relay output circuits in AXM-IO1 and AXM-IO3 modules respectively. The relay output circuit can work in controlling state, or an alarm state. When it operates in controlling state, it has two optional output modes, latching and pulse. When it operates in alarm state, it has only one latching output mode.

Relay type is mechanical Form A contact with 3A/250Vac or 3A/30Vdc. A mediate relay is recommended in the output circuit as in Fig 5-7.

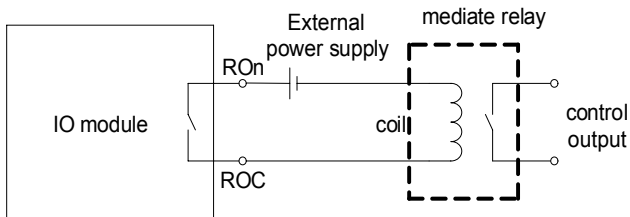

Fig 5-7 schematic diagram of relay output circuit

The wire of relay output should be chosen between AWG22~16 or $0.5\sim 1.3\text{mm}^2$.

Wiring of Digital Output Circuit:

There are 2 digital output circuits in AXM-IO2 module. The digital output circuit can work in alarm state, or work in energy pulse output state.

Digital output circuit form is Photo-MOS. The simplified circuit is shown in Fig 5-8

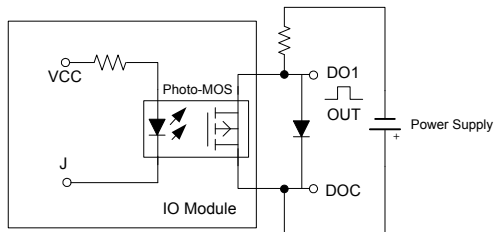

Fig 5-8 schematic diagram of digital output circuit 1

When J is in low state as shown in Fig 5-8, OUT is in low state. When J is in high state, OUT is in high state. OUT can therefore output pulse signals under the control of J.

The max output voltage and current of digital output circuit are 250V and 100mA respectively.

Another drawing of the alarming output with buzzer is shown in Fig 5-9.

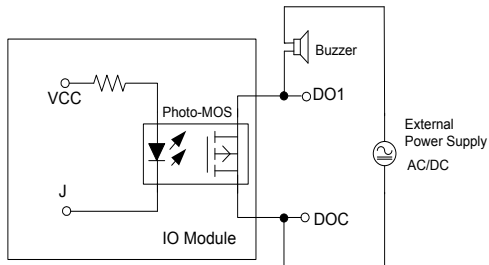

Fig 5-9 schematic diagram of digital output circuit 2

The wire of the digital output circuit should be chosen between AWG22~16 or 0.5~1.3 mm².

Wiring of Analog Output Circuit:

There are 2 analog output circuits in AXM-IO2 modules. The terminals of the analog output circuits are AO1+, AO1- and AO2+, AO2-. The analog output circuit can convert any one of 30 electrical quantities, which is selected by user, to analog voltage or current. The analog output circuit supplies 4 output modes, including 0 to 20mA mode, 4 to 20mA mode, 0 to 5V mode and 1 to 5V mode.

The simplified circuit is as shown in Fig 5-10.

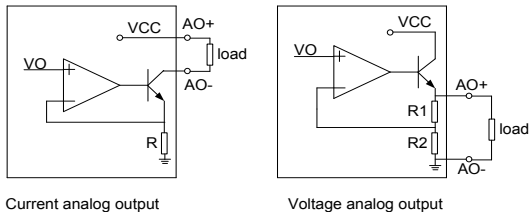

Fig 5-10 schematic diagram of analog output circuit

The Load Capability of Analog Output Circuit:

0 to 20mA mode: the max load resistance is 500Ω.

4 to 20mA mode: the max load resistance is 500Ω.

0 to 5V mode: the max load current is 20mA.

1 to 5V mode: the max load current is 20mA.

Wiring of Analog Input Circuit:

There are 2 analog input circuits in AXM-IO3 modules. The terminals of analog input circuit are AI1+, AI1- and AI2+, AI2-. The analog input circuit supplies 4 input modes, including 0 to 20mA mode, 4 to 20mA mode, 0 to 5V mode and 1 to 5V mode.

The simplified circuit is as shown in Fig 5-11.

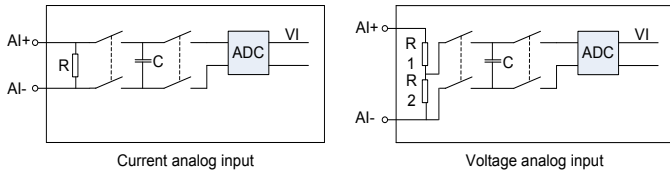

Fig 5-11 schematic diagram of analog input circuit

24V Isolated Power Supply:

To simplify and make more convenient for the end user, there is a DI auxiliary power supply provided in AXM-IO1 module. The voltage of the DI auxiliary power supply is 24Vdc (1W). This power supply can NOT be used for other purposes.

Fig 5-12 shows the function of IO modules, which is displayed in the utility software as follows, where AXM-IO12 (AXM-IO1 module in logic NO.2), AXM-IO22 (AXM-IO2 module in logic NO.2) and AXM-IO32 (AXM-IO3 module in logic NO.2) are linked to Acuvim II meter.

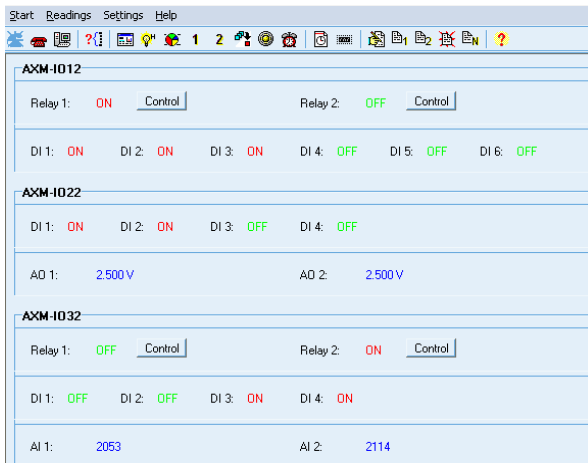

Fig 5-12 functions of IO modules

5.1.6 Detection of Remote Signals

The digital input circuit can be set to detect remote signals.

a. Detection of Remote Signals

When digital input circuit detects a qualified voltage input, it will show “1” on screen and “ON” in utility software. Otherwise, it will show “0” on screen and “OFF” in utility software.

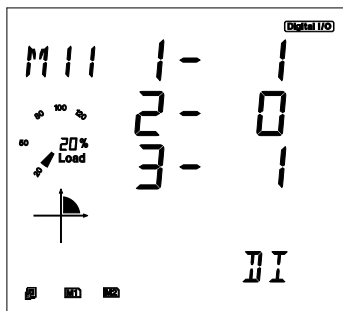

Fig 5-13 showing DI state on screen

b. Record of SOE

When the digital input circuit is set to detect remote signals, the recording function of SOE can be enabled. Therefore, when the remote signals change, the IO module can record this information accordingly.

SOE Record: including "4399H to 4439H" address registers. "4399H to 4438H" address registers record 20 groups of SOE records. "4439H" records the IO module which generates the SOE records. For example, if register "4439H" is 1, the 20 groups of SOE records are all generated by AXM-IO11 (AXM-IO1 module in logic NO.1).

The 20 groups of SOE records are arranged based on time. When more than 20 groups of SOE records are generated, the records will begin at the first one.

When the Acuvim II meter is powered on, the SOE begins to record immediately. The data in the SOE records will not be lost if the meter is powered off. When the enabled SOE function is changed, the records will be lost.

All groups of SOE records are in the same format. Take the first group of SOE records for example, “4399H to 439FH” registers record the time information, including year, month, day, hour, minute, second and millisecond. “43A0H” register records the state information, which is an unsigned integer, where bit 0 records DI1 state, bit 1 records DI2 state, and so on. For example, if “43A0H” is “1”, it means that DI1 is “1”, and others are all “0”.

Note: If one of digital input circuits is set to be a pulse counter when the IO module is SOE enabled, then the counterpart bit of “43A0H” register will always be “0”.

Data of SOE records can only be read by the utility software, it cannot be read on screen.

Fig 5-14 shows the data information of SOE records of AXM-IO12 (AXM-IO1 module in logic NO.2) read by the utility software.

No.	Time Stamp	ms	DI 1	DI 2	DI 3	DI 4	DI 5	DI 6
1	2007-6-28 15:20:22	603	OFF	OFF	OFF	OFF	OFF	OFF
2	2007-6-28 15:20:43	969	ON	ON	ON	OFF	OFF	OFF
3	2007-6-28 15:20:43	969	ON	ON	ON	OFF	OFF	OFF
4	2007-6-28 15:20:43	969	ON	ON	ON	OFF	OFF	OFF
5	2007-6-28 15:20:43	969	ON	ON	ON	OFF	OFF	OFF
6	2007-6-28 15:20:49	328	OFF	ON	OFF	OFF	OFF	OFF
7	2007-6-28 15:20:49	329	OFF	OFF	OFF	OFF	OFF	OFF
8	2007-6-28 15:20:04	653	OFF	OFF	OFF	OFF	OFF	ON
9	2007-6-28 15:20:04	654	OFF	OFF	OFF	OFF	OFF	OFF
10	2007-6-28 15:20:08	224	ON	ON	ON	OFF	OFF	OFF
11	2007-6-28 15:20:08	224	ON	ON	ON	OFF	OFF	OFF
12	2007-6-28 15:20:08	224	ON	ON	ON	OFF	OFF	OFF
13	2007-6-28 15:20:15	45	ON	ON	ON	ON	ON	OFF
14	2007-6-28 15:20:15	45	ON	ON	ON	ON	ON	OFF
15	2007-6-28 15:20:15	47	ON	ON	ON	ON	ON	ON
16	2007-6-28 15:20:19	239	OFF	OFF	OFF	ON	ON	ON
17	2007-6-28 15:20:19	239	OFF	OFF	OFF	ON	ON	ON
18	2007-6-28 15:20:19	239	OFF	OFF	OFF	ON	ON	ON
19	2007-6-28 15:20:22	601	OFF	OFF	OFF	ON	OFF	ON
20	2007-6-28 15:20:22	602	OFF	OFF	OFF	OFF	OFF	ON

Newest SOE Record No. 7
SOE Records from AXM-IO12

Fig 5-14 data information of SOE records read by the utility software

c. Parameter Setting of Detection of Remote Signals

Take parameter setting of AXM-IO11 (AXM-IO1 module in logic NO.1) for example.

“109EH” register: this register is an unsigned integer, where bit0 determines DI1’s working mode, bit1 determines DI2’s working mode, and so on. If the bit is “1”, then the DI circuit is set to be a pulse counter. Otherwise, the DI circuit is set to detect remote signals. Fig 5-13 shows the parameter setting of digital input circuits.

“101BH” register: this register is an unsigned integer, it determines that which IO module will be SOE enabled. If register is “0”, then any IO module is SOE disabled. If register is “1”, then AXM-IO11 (AXM-IO1 module in logic NO.1) is SOE enabled. If register is “2”, then AXM-IO21 (AXM-IO2 module in logic NO.1) is SOE enabled. If register is “3”, then AXM-IO31 (AXM-IO3 module in logic NO.1) is SOE enabled. If register is “4”, then AXM-IO12 (AXM-IO1 module in logic NO.2) is SOE enabled. If register is “5”, then AXM-IO22 (AXM-IO2 module in logic NO.2) is SOE enabled. If register is “6”, then AXM-IO32 (AXM-IO3 module in logic NO.2) is SOE enabled. Only one IO module can be SOE enabled at one time. If the IO module is not linked to the Acuvim II power meter, then there is no need to enable SOE function in the software.

Fig 5-15 shows the parameters setting of IO module’s SOE function.

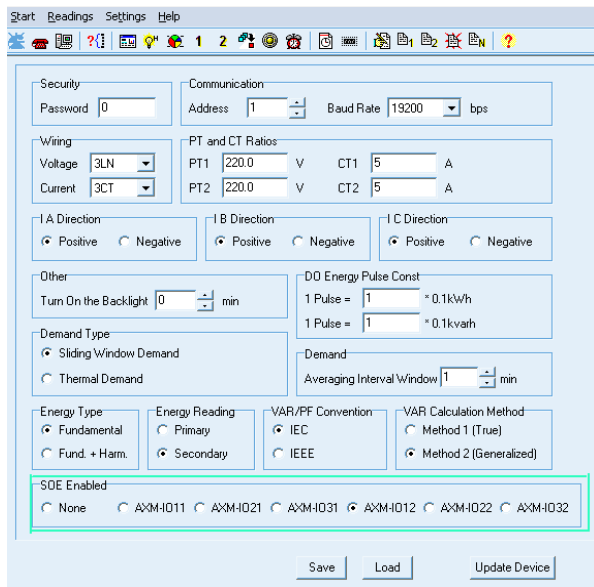

Fig 5-15 parameters setting of IO module's SOE function

5.1.7 Pulse Counter

The digital input circuit can also be set to count pulses.

Recorded number of pulses: including "4349H to 4380H" address The "4349H to 4380H" registers record 28 groups of individual number of individual number of pulses. This includes 6 groups of records for AXM-I011 (AXM-I01 module in logic

NO.1), 4 groups of records for AXM-IO21 (AXM-IO2 module in logic NO.1), 4 groups of records for AXM-IO31 (AXM-IO3 module in logic NO.1), 6 groups of records for AXM-IO12 (AXM-IO1 module in logic NO.2), 4 groups of records for AXM-IO22 (AXM-IO2 module in logic NO.2) and 4 groups of records for AXM-IO32 (AXM-IO3 module in logic NO.2) in sequence. One group of records is an unsigned long integer, for example, "4349H to 434aH" registers record the number of pulses for DI1 circuit of AXM-IO11 (AXM-IO1 module in logic NO.1).

Fig 5-16 shows the recorded number of pulses read on screen.

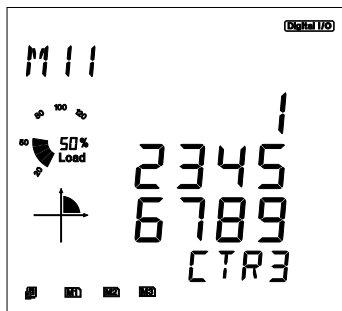

Fig 5-16 recorded number of pulses read on the screen

Fig 5-17 shows the recorded number of pulses read by the utility software.

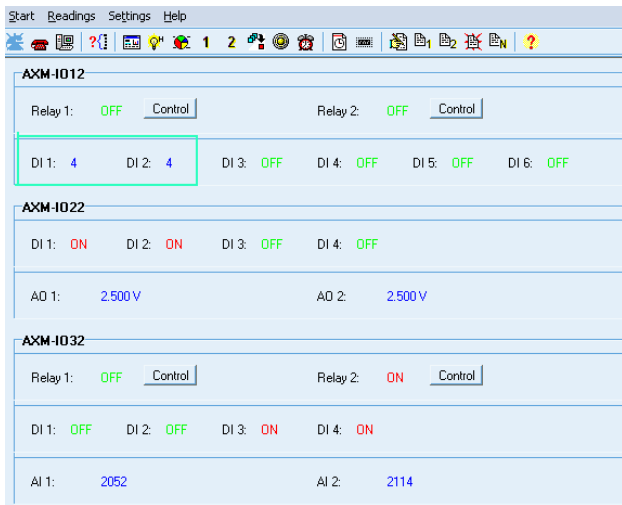

Fig 5-17 recorded number of pulses read by the utility software

Parameter Settings for Counting Input Pulses:

Take AXM-IO11 (AXM-IO1 module in logic NO.1) for example.

1. "109EH" register: if the bit is set as "1", the counterpart digital input circuit is set to be a counter of input pulses.
2. "109FH" register: this register is an unsigned integer. If this register is A, and the digital input circuit is set to be a pulse counter, then the real number of pulses counted by this DI circuit will be as follows:

Real number of pulses = $A \times$ Recorded number of pulses.

For example, if $A=20$, the recorded number of pulses counted by DI1 circuit of AXM-IO11 is 100 (4349H to 434aH registers), then the real number of pulses is $20 \times 100 = 2000$.

The parameter setting is shown in Fig 5-15.

5.1.8 Relay Output

Relays in IO modules can work in two different modes, one is controlling mode, and the other is alarm mode. For controlling mode, relays can be switched on and off directly. For alarm mode, the action of relays is controlled by whether the alarm has occurred or not.

There are two mode selections for relay output, one is latching, and the other is pulse. For the latching mode, the relay can be used to output two status on or off. For the pulse mode, the output of the relay changes from off to on for a period of time and then goes off. The period can be set from 50 to 3000ms.

Note: when relay is working in alarm mode, the default output mode is latching mode.

a. Display of Relay State

If relay state is "ON", it means that relay is switched on. If relay state is "OFF", it means that relay is switched off.

Fig 5-18 shows the status of relays read on screen.

Fig 5-12 shows the status of relays read by the utility software.

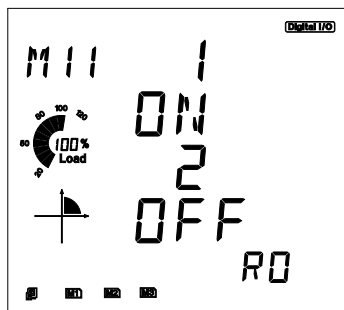

Fig 5-18 status of relays read on screen

b. Parameter Setting

Take AXM-IO11 (AXM-IO1 module in logic NO.1) for example.

“RO working mode (10A0H)” register: this register determines the working mode of relays. If the register is “0”, then RO1 and RO2 will work in controlling mode. If the register is “1”, then RO1 and RO2 will work in alarm mode.

“RO output mode (10A1H)” register: this register determines the output mode of relays. If the register is “0”, then RO1 and RO2 will work in latching output mode. If the register is “1”, then RO1 and RO2 will work in pulse output mode.

“RO pulse width (10A2H)” register: when the relays are working in pulse mode, this register determines the period of time which can be set from 50 to 3000ms. For example, if this register is “100”, the relay (RO1 or RO2) will be switched on for 100ms after receiving ON instruction and then be switched off.

The parameter setting is shown in Fig 5-15.

5.1.9 Digital Output

There are two mode selections for the digital output circuit; one being alarm mode, and the other being energy output mode. For alarm mode, action of digital output circuit is controlled by whether the alarm is triggered or not. For energy output mode, digital output circuits can output various types of energy, such as import active energy, export active energy, import reactive energy and export reactive energy. When outputting energy pulses, pulse width can be set from 20 to 1000ms. The minimum interval between two pulses is 20ms.

Parameter Setting:

Take AXM-IO21 (AXM-IO2 module in logic NO.1) for example.

“DO working mode (10A5H)” register: this register determines the working mode of DO circuits. If the register is “0”, then DO1 and DO2 will work in energy output mode. If the register is “1”, then DO1 and DO2 will work in alarm mode.

“DO pulse width (10A6H)” register: when DO circuits work in energy output mode, this register determines the width of energy pulses.

“DO1 output type (10A7H)” register: when DO circuits work in energy output mode, this register determines the energy output type for DO1. If this register is “0”, DO1 outputs nothing. If this register is “1”, DO1 outputs import active energy. If this register is “2”, DO1 outputs export active energy. If this register is “3”, DO1 outputs import reactive energy. If this register is “4”, DO1 outputs export reactive energy.

“DO2 output type (10A8H)” register: when DO circuits work in energy output mode, this register determines the energy output type for DO2. The value of this register is defined as the same as “DO1 output type” register.

“DO1 output type” register and “DO2 output type” register can be set to the same value or not.

The parameter setting is shown in Fig 5-19.

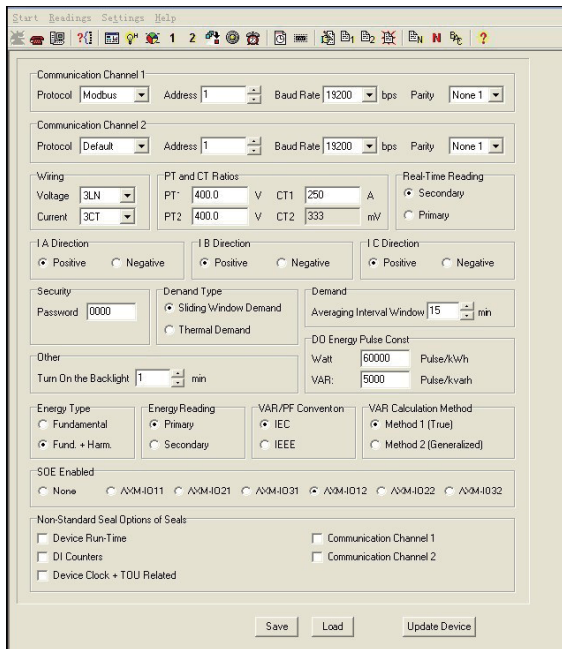

Fig 5-19 parameter setting of DO energy pulse constant

5.1.10 Analog Output

1. Analog Output Relationship with Electrical Quantities

The analog output circuit can convert anyone of 30 electrical quantities (reference Chapter 6), which is selected by user, to analog voltage or current.

The analog output circuit supplies 4 output modes, including 0 to 20mA mode, 4 to 20mA mode, 0 to 5V mode and 1 to 5V mode.

Fig 5-20 shows the relationship between analog output and various electrical quantities.

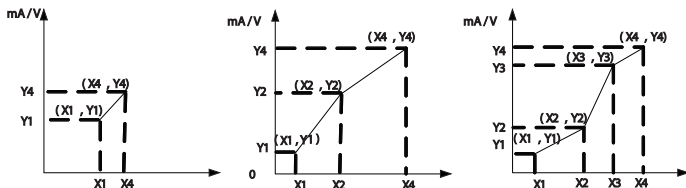

Fig 5-20 Relationship between analog output and various electrical quantities

Note: Following part introduce how AO function works.

Addresses about AO function are from 10D0H to 10F3H, which include three groups parameters, such as Gradient Number, AO following value range, AO output range.

1) AO Gradient Number Selection of input/output transfer curve

When number is 1, which includes (X1, Y1) and (X4, Y4), only AO following value range setting start point, AO following value range setting end point, AO1 output range setting start point and AO1 output range setting end point should be set.

When number is 2, which includes (X1, Y1), (X2, Y2) and (X4, Y4), only AO following value range setting start point, AO1 following value range setting point 2, AO following value range setting end point, AO1 output range setting start point , AO1 output range setting point 2 and AO1 output range setting end point should be set.

When number is 3, which includes (X1, Y1), (X2, Y2) , (X3, Y3) and (X4, Y4), only AO following value range setting start point, AO1 following value range setting point 2, AO1 following value range setting point 3 and AO following value range setting end point should be set. At the same time, AO1 output range setting start point, AO1 output range setting point 2, AO1 output range setting point 3 and AO1 output range setting end point should be set.

2) Following value range setting:

AO following value range setting start point (X1), AO1 following value range setting point 2 (X2), AO1 following value range setting point 3 (X3) and AO following value range setting end point (X4) are increasing value, while they should be within range of AO following value. Otherwise, the function of AO will be affected.

Frequency: 45HZ~65HZ, real setting value is 4500~6500(50Hz or 60Hz type); 300.00Hz ~ 500.00Hz, real setting value is 30000 ~ 50000(400Hz type).

Phase voltage V1, V2, V3 and average phase voltage: 0~480V, real setting value is 0~4800.

Line voltage V12, V23, V31 and average line voltage: 0~831V, real setting value is 0~8310.

Current I1, I2, I3 and average current: 0~10A, real setting value is 0~10000.

Power Pa, Pb and Pc: -4800~4800W, real setting value is -4800~4800

System power: -14400~14400W, real setting value is -14400~14400.

Reactive power Q_a , Q_b and Q_c : -4800~4800 Var, real setting value is -4800~4800.

System reactive power: -14400~14400 Var.

Apparent power S_a , S_b and S_c : 0~4800VA, real setting value is 0~4800.

System apparent power: 0~14400VA, real setting value is 0~14400.

Power factor PF_a , PF_b , PF_c and System power factor: -1~1, real setting value is -1000~1000.

3) AO output range setting:

AO output value range setting start point (Y1), AO1 output value range setting point 2 (Y2), AO1 output value range setting point 3 (Y3) and AO output value range setting end point (Y4) are increasing value, while they should be within range of AO output value.

When AO type is 0~20mA, the corresponding range is 0~24mA, the setting value range is 0~4915, and the relationship is $mA = \text{setting value} * 20 / 4096$.

When AO type is 4~20mA, the corresponding range is 4~24mA, the setting value range is 819~4915, and the relationship is $mA = \text{setting value} * 20 / 4096$.

When AO type is 0~5V, the corresponding range is 0~6V, the setting value range is 0~4915, and the relationship is $V = \text{setting value} * 5 / 4096$.

When AO type is 1~5V, the corresponding range is 1~6V, the setting value range is 819~4915, and the relationship is $V = \text{setting value} * 5 / 4096$.

Please note:

a> If the voltage input wiring of the meter is 2LL or 3LL, then the analog output relative to phase voltage, neutral current, phase active/reactive/apparent power and phase power factor will always be 0.

b> The maximum of analog output is 1.2 times the range.

2. Display of Analog Output

Value of analog output is displayed in hex on screen. The relationship between displayed value and real value of analog output is:

$$\text{Real value} = \frac{\text{Displayed Value}}{4096} \times 20\text{mA (current output mode)}$$

$$\text{or Real value} = \frac{\text{Displayed Value}}{4096} \times 5\text{V (voltage output mode)}$$

As shown in Fig 5-21, the displayed value of AO1 is 0x0800, so the real value of AO1 is $(0\text{x}0800/4096) \times 5\text{V}$ or $(0\text{x}800/4096) \times 20\text{mA}$.

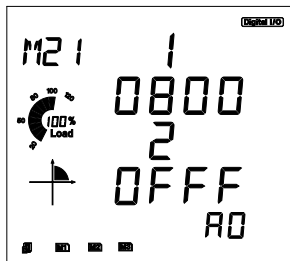

Fig 5-21 AO value read on screen

3. Parameter Setting

Take AXM-IO21 (AXM-IO2 module in logic NO.1) for example.

“Electrical quantities relative to AO1 (10C2H)” register: this register determines which electrical quantity AO1 should be relative to. (see Chapter 6 for explanation). For example, if this register is “0”, then AO1 is relative to

“Frequency”.

“Electrical quantities relative to AO2 (10C3H)” register: this register determines which electrical quantity AO2 should be relative to. The value of this register is defined as the same as “Electrical quantities relative to AO1 (10C2H)” register.

“Electrical quantities relative to AO1 (10C2H)” register and “Electrical quantities relative to AO2 (10C3H)” register can be set to the same value .

The parameter setting is shown in Fig 5-22

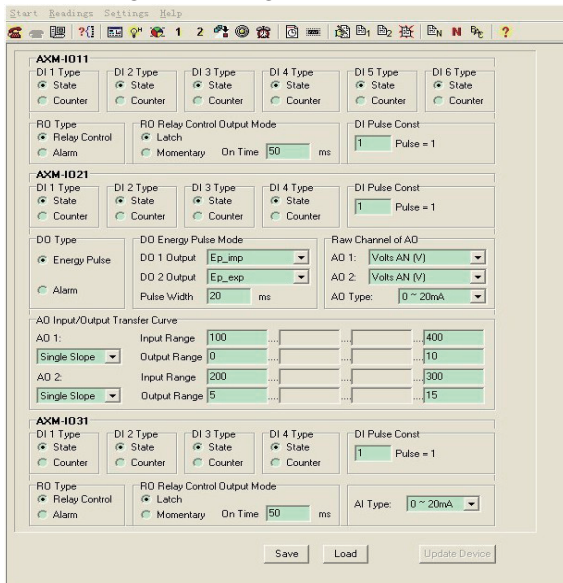

Fig 5-22 Parameter setting of IO modules

5.1.11 Analog Input

Analog input circuits supply 4 types of input modes, including 0 to 20mA mode, 4 to 20mA mode, 0 to 5V mode, and 1 to 5V mode.

Fig 5-23 shows the relationship between AI value and input analog value.

AI value ranges from 0 to 4095 without any unit. AI value is displayed in hex on screen.

Fig 5-24 shows the AI value read on screen.

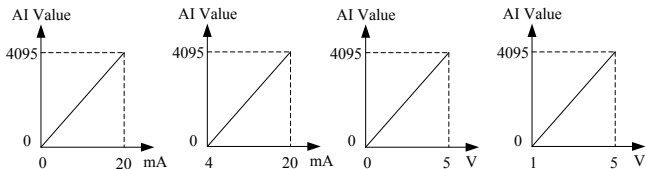

Fig 5-23: relationship between AI value and input analog value

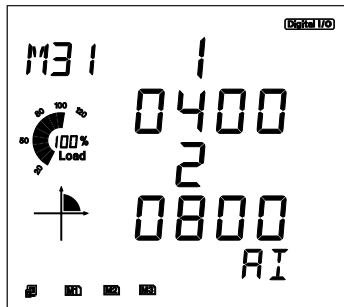

Fig 5-24 AI value read on screen

5.2 Ethernet Module (AXM-NET)

5.2.1 Introduction to Ethernet

Ethernet was originally developed by Xerox and then developed further by Xerox, DEC, and Intel. Ethernet uses a Carrier Sense Multiple Access with Collision Detection (CSMA/CD) protocol, and provides transmission speeds up to 10 Mbps.

Now Ethernet stands for LAN with CSMA/CD protocol.

Ethernet is the most current communication standard in LAN. This standard defines the used type of cable and the method of Signal processing in LAN.

5.2.2 Function Description of Ethernet module

Please read appendix of technical data and specifications of Ethernet module before using.

- * The Ethernet module supports Modbus-TCP protocol. It is used as a server, the default value of the protocol port is 502, and the user defined range of the protocol port is 2000~5999. The device address is communication address 2(0×1031H).
- * The Ethernet module supports SMTP protocol. It has an email function and supports "Send mail for timing" mode and "Send mail for event" mode.
- * The Ethernet module supports HTTP protocol. It is used as an HTTP server, the default value of the protocol port is 80, and the scope of the protocol port is 6000~9999.
- * The Ethernet module supports SNTP protocol. It can get update time to Coordinated Universal Time (UTC).

5.2.3 Appearance and Dimensions

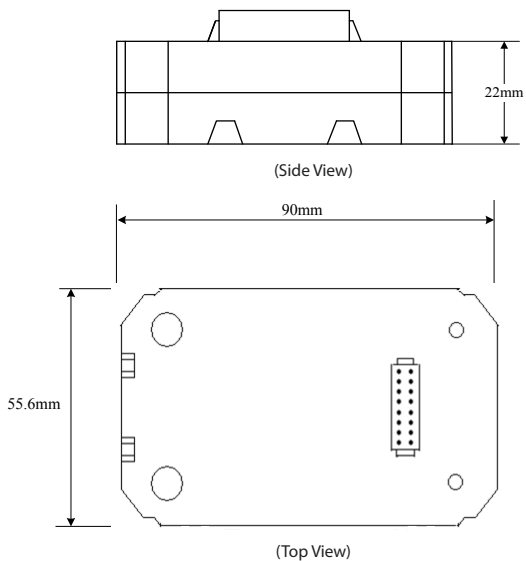

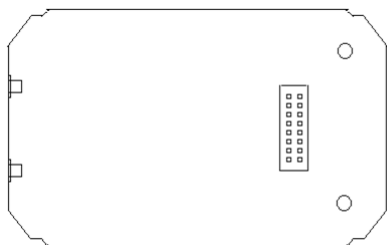

(Bottom View)

5.2.4 Installation Method

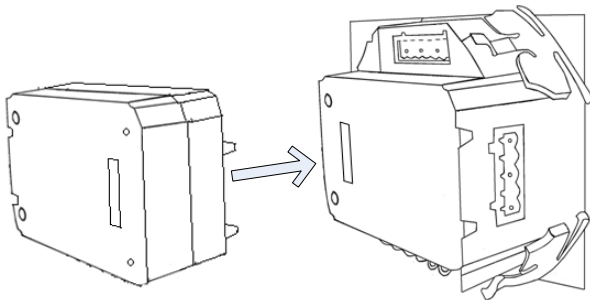

The Ethernet module is linked to the Acuvim II meter by a communication plug. It can also be linked to other extended modules like IO modules.

1. Insert the installation clips to the counterpart of the meter, and then press the Ethernet module lightly, so linking is established.
2. Tighten the installation screws.

Note:

1. Install Ethernet Module carefully to avoid damage;
2. Under no circumstances should any installation be done with the meter powered on. Failure to do so may result in injury or death.

5.2.5 Definition of RJ45 Interface

The Ethernet module uses a standard RJ45 connector to access the Ethernet network. The mechanical and electrical characteristics of the connectors comply with the requirements of IEC 603-7.

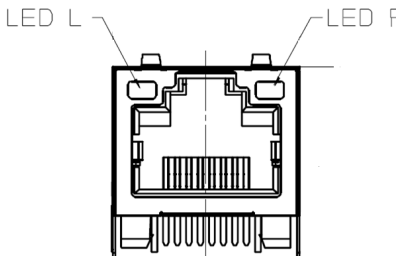

(Top View)

Script	ID	Content
1	TX+	Tranceive Data+
2	TX-	Tranceive Data-
3	RX+	Receive Data+
4	n/c	Not connected
5	n/c	Not connected
6	RX-	Receive Data-
7	n/c	Not connected
8	n/c	Not connected

LED_L (yellow): displays speed status. LED on indicates 100Mbps, while LED off indicates 10Mbps.

LED_R (green): displays link and activity status combined. LED on indicates link status, while flashing LED indicates activity status.

5.2.6 Cable

Shielded twisted-pair cable (standard 568A or standard 568B) is usually recommended as reference to the EIA/TIA standard.

5.2.7 Connection Method

1. Direct Connect

The Ethernet module uses cross line (standard 568A) to connect to computers. The module supports Modbus-TCP, HTTP and SNMP functions for a direct connection.

2. Indirect Connect

The Ethernet module uses straight line (standard 568B) to access the Ethernet through a router or hub.

5.2.8 Initializing Ethernet Module

AXM-NET Module's default settings are as follows:

IP Address (192.168.1.254);

Subnet Mask (255.255.255.0);

Gateway (192.168.1.1);

This information can be found by using the keys on the meter front. The following process shows how to configure Ethernet module settings by using the front panel:

1. Pressing "H" key and "V/A" key simultaneously on the meter will go to the menu selecting mode. Cursor "Meter" flashes in this mode.

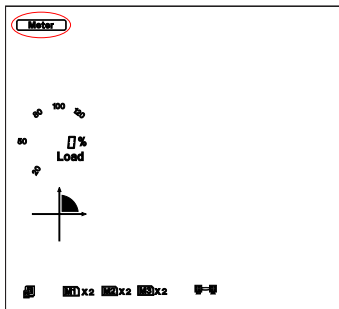

Fig 5-25

2. Press "P" key or "E" key to move the cursor to "Setting". Press "V/A" key to go to the meter parameter setting mode. Device address page is the first page of "Setting" mode. It shows the Modbus address of the device for several seconds, and then the screen goes to Access Code page. Press "V/A" key to go to the parameter setting page. Press "P" key or "E" key to move the cursor to "NET". Press "V/A" key to go to the Ethernet module setting page.

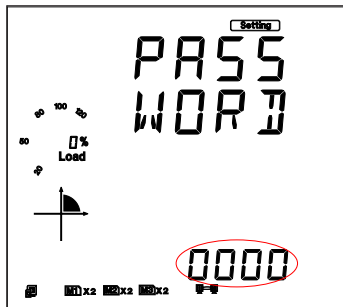

Fig 5-26

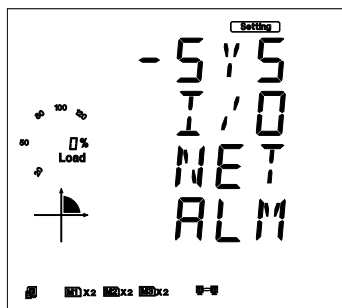

Fig 5-27

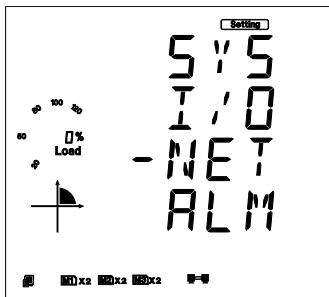

Fig 5-28

3. Set configuration mode in the first setting page. “AUTO” means that users configure module settings with DHCP protocol while “MANU” means that users configure module settings with manual setting. Press “V/A” key, to go to the setting state and the area pointed out in Fig 5-29 will flash. Press “P” key or “E” key to select configuration mode, press “V/A” key to accept. Press the “P” key again to go to the second setting page for IP Address.

Note: If you select the “AUTO” mode, please go to step 11 directly and reset module. Wait until the reset is finished and find the new IP address in the following step.



Fig 5-29

4. Set IP Address in the second setting page, such as 192.168.1.254 as shown below. Press the "V/A" key to go to the IP setting page. Users may set the parameters in the area pointed out in Figure 5-30. The cursor starts at the first digit. After setting the IP address press the "V/A" key to accept. Press the "P" key again to go to the third setting page for Subnet Mask.

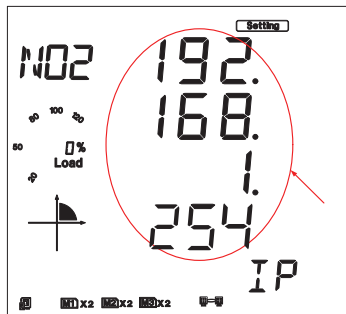

Fig 5-30

5. Set Subnet Mask in the third setting page, such as 255.255.255.0. Press "V/A" key to go to the setting page. Users may set the parameters in the area pointed out in Fig 5-31. The cursor starts at the first digit. After setting the Subnet Mask, press the "V/A" key to accept. Press the "P" key again to go to the fourth setting page for Gateway.

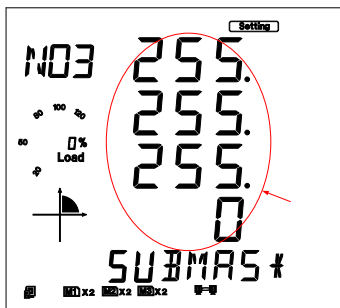

Fig 5-31

6. Set Gateway in the fourth setting page, such as 192.168.1.1. Press the "V/A" key to go to the setting page. Users may set the parameters pointed out in Fig 5-32. The cursor starts at the first digit. After setting the Gateway, press the "V/A" key to accept. Press the "P" key to go to the fifth setting page for DNS Primary Server.

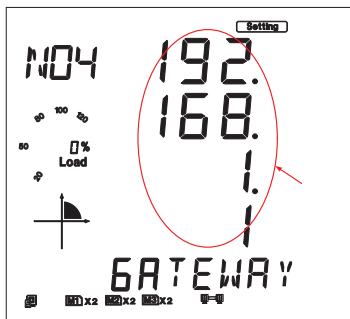

Fig 5-32

7. Set DNS Primary Server in the fifth setting page, such as 202.106.0.20. Press the "V/A" key to go to the setting page. Users may set the parameters pointed out in Fig 5-33. The cursor starts at the first digit. After setting the DNS Primary Server, press the "V/A" key to accept. Press the "P" key to go to the sixth setting page for DNS Secondary Server.

Note: the DNS parameters must be set correctly to use the SMTP functions.

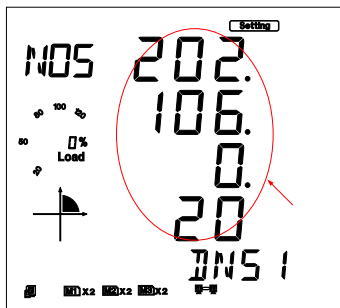

Fig 5-33

8. Set DNS Secondary Server in the sixth setting page, such as 202.106.196.115. Press the "V/A" key to go to the setting page. Users may set the parameters pointed out in Fig 5-34. The cursor starts at the first digit. After setting the DNS Secondary Server, press the "V/A" key to accept. Press the "P" key to go to the seventh setting page for the Modbus-TCP port.

Note: the DNS paramters must be set correctly in order to use the SMTP functions.

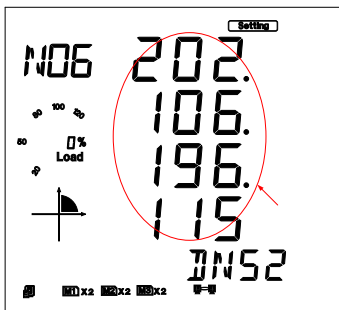

Fig 5-34

9. Set Modbus-TCP port in the seventh setting page, such as 502. Press the "V/A" key to go to the setting page. Users may set the parameters pointed out in Fig 5-35. The cursor starts at the first digit. After setting the Modbus-TCP port, press the "V/A" key to accept. Press the "P" key to go to the eighth setting page for the HTTP port. The Modbus-TCP port's default value is 502, and the user defined range of port is 2000~5999. If the set port is not in the correct range, the set port will return to the default value.

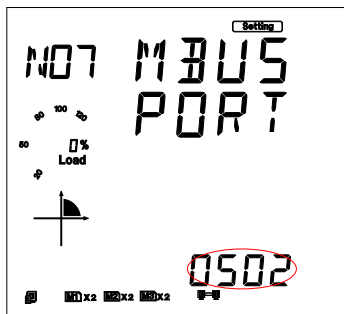

Fig 5-35

10. Set HTTP port in the eighth setting page, such as 80. Press the "V/A" key to go to the setting page. Users may set the parameters pointed out in Fig 5-36. The cursor starts at the first digit. After setting the HTTP port, press the "V/A" key to accept. Press the "P" key to go to the ninth setting page for the reset mode. The HTTP port's default value is 80, and the user defined range of port is 6000~9999. If the set port is not in the correct range, the set port will return to the default value.

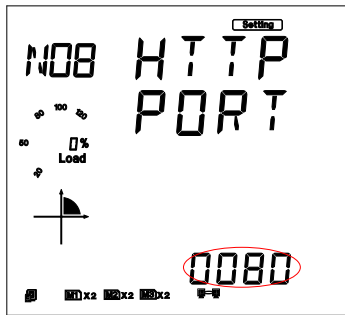

Fig 5-36

11. Set resetting mode in the ninth setting page. Select "RESET" to reset the module. Selecting "NO" will not reset the module. Selecting "DEFAULT" will load the module with default settings and reset module. Press the "V/A" key to go to the setting page and the parameter pointed out in Fig 5-37 will flash. Press the "P" or "E" key to select the configuration mode. Press the "V/A" key to accept.

Note: When configuring Ethernet module settings completely, users must select "RESET" to restart module and new settings will take effect.

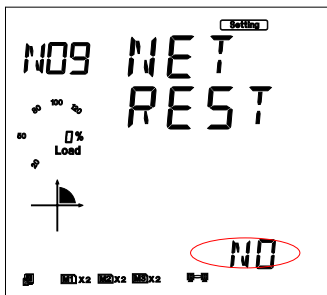

Fig 5-37

12. The password of AXM-NET module can be reset by selecting "RESET". The password then becomes "12345678". Selecting "NO" means no change. Press "V/A" key to accept.

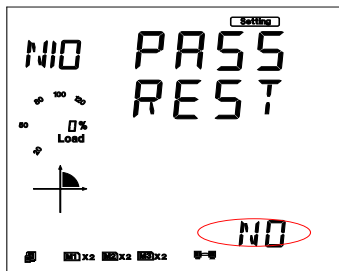

Fig 5-38

13. After configuring AXM-Net settings completely, press "H" key and "V/ A" key simultaneously to return to menu selecting mode.

5.2.9 Searching IP Address of Ethernet Module

The utility software of Acuvin II series meter supports a meter search function. Users can use this function to obtain IP addresses, MAC addresses and all parameters of Ethernet Modules.

Operation steps:

- 1) Click “Start” menu of utility software.
- 2) Click “Search Device” menu.

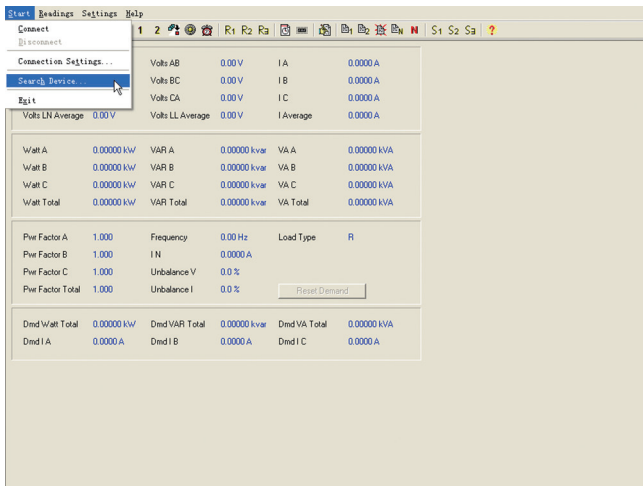

Fig 5-39

3) Utility software pop-ups “Search Device(s)” window, and the window displays IP address and MAC address of module.

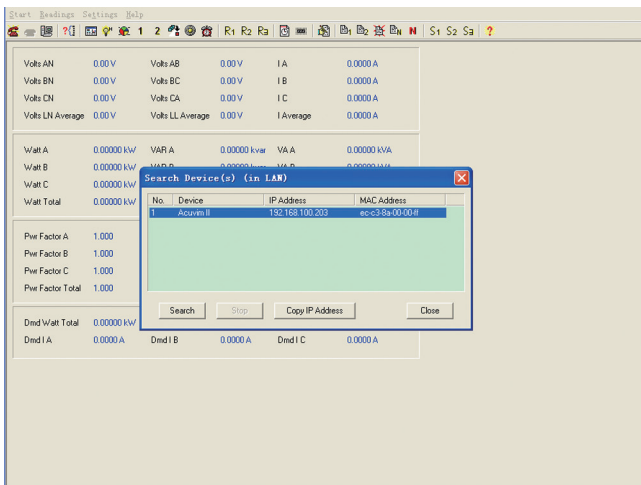

Fig 5-40

Note: This function is used only in LAN, not used in WAN or direct connect to computer.

5.2.10 Description of Modbus-TCP protocol

The Modbus-TCP protocol is used for communication in Ethernet modules. The protocol sets up master/slave link in Ethernet. First, master device (client) sets up TCP link with slave device (server). Second, master device sends request frame to slave device, and slave device receives request frame and returns response frame to master device. Fig 5-41 displays working mode of Modbus-TCP protocol.

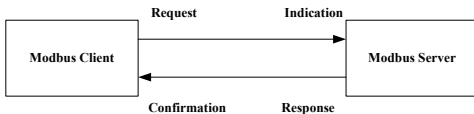

Fig 5-41

1. Protocol

a. Data Frame Format

Table 5-2

MBAP Header	Function	Data
7x8-Bits	8-Bits	Nx8-Bits

b. Modbus Application Header (MBAP Header) Field

The Modbus application header field is the start of the data frame and consists of seven bytes.

Table 5-3

Field	Length	Description
Transaction Identifier	2 Bytes	Identification of a Modbus Request/Response transaction
Protocol Identifier	2 Bytes	Modbus protocol=0
Length	2 Bytes	Number of following bytes
Unit Identifier	1 Byte	Slave address, in the range of 0~247 decimal.

c. Function Field

The function code field of a message frame contains eight bits. Valid codes are in the range of 1~255 decimal. When a message is sent from a client to a server device the function code field tells the server what kind of action to perform.

Table 5-4

Code	Meaning	Action
01	Read Relay Output Status	Obtain current status of Relay Output
02	Read Digital Input(DI) Status	Obtain current status of Digital Input
03	Read Data	Obtain current binary value in one or more registers
05	Control Single Relay Output	Force Relay to a state of on or off
16	Write Multiple-registers	Place specific value into a series of consecutive multiple-registers

d. Data Field

The data field is constructed using sets of two hexadecimal digits, in the range of 00 to FF hexadecimal. The data field of messages sent from a master to slave devices contains additional information which the slave must use to take the action defined by the function code. This can include items like discrete and register addresses, the quantity of items to be handled, and the count of actual data bytes in the field. For example, if the master requests a slave to read a group of holding registers (function code 03), and the data field specifies the starting register and how many registers are to be read. If the master writes to a group of registers in the slave (function code 10 hexadecimal), the data field specifies the starting register, how many registers to write, the count of data bytes to follow in the data field, and the data to be written into the registers.

2. Format of communication

Explanation of frame

Table 5-5

Transaction identifier hi	Transaction identifier lo	Protocol identifier hi	Protocol identifier lo	Length hi	Length lo	Unit identifier
00H	00H	00H	00H	00H	06H	01H
Fun	Data start reg hi	Data start reg lo	Data #of regs hi	Data #of regs lo		
03H	40H	00H	00H	48H		

As shown in Table 5-5 the meaning of each abbreviated word is:

Transaction identifier hi: Transaction Identifier high byte

Transaction identifier lo: Transaction Identifier low byte

Protocol identifier hi: Protocol Identifier high byte

Protocol identifier lo: Protocol Identifier low byte

Length hi: length high byte

Length lo: length low byte

Unit identifier: slave address

Fun: function code

Data start reg hi: start register address high byte

Data start reg lo: start register address low byte

Data #of regs hi: number of register high byte

Data #of regs lo: number of register low byte

a. Read Status Relay (Function Code 01)

Function Code 01

This function code is used to read relay status in Acuvim II series meter.

1=On

0=Off

There are 8 Relays in the meter, and the starting address is 0000H.

The following query is to read 2 Relays Status of the meter Address 1.

Query

Table 5-6 Read 2 Relays Status Query Message

Transaction identifier hi	Transaction identifier lo	Protocol identifier hi	Protocol identifier lo	Length hi	Length lo	Unit identifier
00H	00H	00H	00H	00H	06H	01H

Fun	Data start reg hi	Data start reg lo	Data #of regs hi	Data #of regs lo
01H	00H	00H	00H	02H

Response

The Acuvim II series meter response includes MBAP Header, function code, quantity of data byte and the data. For example response to read the status of Relay 1 and Relay 2 is shown as Table 5-6. The status of Relay 1 and Relay 2 is responding to the last 2 bit of the data.

Table 5-7 Read 2 Relays Status Response Message

Relay 1: bit0

Relay 2: bit1

Transaction identifier hi	Transaction identifier lo	Protocol identifier hi	Protocol identifier lo	Length hi	Length lo	Unit identifier
00H	00H	00H	00H	00H	04H	01H

Fun	Byte count	Data
01H	01H	02H

The content of the data is,

7	6	5	4	3	2	1	0
0	0	0	0	0	0	1	0

MSB LSB

(Relay 1 = OFF , Relay 2=ON)

b. Read Status of DI (Function Code 02)

Function Code 02

1=On

0=Off

There are 38 DIs in the meter, and the starting address is 0000H.

The following query is to read the 4 DIs Status of address 1 of Acuvim II series meter.

Query

Table 5-8 Read 4 DIs Query Message

Transaction identifier hi	Transaction identifier lo	Protocol identifier hi	Protocol identifier lo	Length hi	Length lo	Unit identifier
00H	00H	00H	00H	00H	06H	01H
Fun	Data start reg hi	Data start reg lo	Data #of regs hi	Data #of regs lo		
02H	00H	00H	00H	04H		

Response

The response includes MBAP Header, function code, quantity of data characters and the data characters.

An example response to read the status of 4 DIs (DI1=On, DI2=On, DI3=On, DI4=On) is shown as Table 5-9. The status of each is responding to the last 4 bit of the data.

Table 5-9 Read 4 DIs Response Message

DI1: bit0		DI2: bit1		DI3: bit2		DI4: bit3
Transaction identifier hi	Transaction identifier lo	Protocol identifier hi	Protocol identifier lo	Length hi	Length lo	Unit identifier
00H	00H	00H	00H	00H	04H	01H
Fun	Byte count	Data				
02H	01H	0FH				

The content of the data is,

7	6	5	4	3	2	1	0
0	0	0	0	1	1	1	1

MSB

LSB

c. Read Data (Function Code 03)

Query

This function allows the users to obtain the measurement results of Acuvim II series meter.

Table 5-9 is an example of reading the 6 measured data (Time) from server device address 1, the data start address is 1040H.

Table 5-10 Read Time Query Message

Transaction identifier hi	Transaction identifier lo	Protocol identifier hi	Protocol identifier lo	Length hi	Length lo	Unit identifier
00H	00H	00H	00H	00H	06H	01H
Fun	Data start reg hi	Data start reg lo	Data #of regs hi	Data #of regs lo		
03H	10H	40H	00H	06H		

Response

An example response to read Time (2006-12-18 14:15:20) is shown as Table 5-10.

Table 5-11 Read Time Response Message

Transaction identifier hi	Transaction identifier lo	Protocol identifier hi	Protocol identifier lo	Length hi	Length lo	Unit identifier
00H	00H	00H	00H	00H	0FH	01H

Fun	Byte count	Data1 hi	Data1 lo	Data2 hi	Data2 lo	Data3 hi	Data3 lo	Data4 hi	Data4 lo	Data5 hi	Data5 lo	Data6 hi	Data6 lo
03H	0CH	07H	D6H	00H	0CH	00H	12H	00H	0EH	00H	0FH	00H	14H

d. Control Relay (Function Code 05)

Query

The message forces a single Relay either on or off. Any Relay that exists within the Acuvim II series meter can be forced to be either status (on or off). The address of Relay starts at 0000H, and the meter has eight Relays.

The data value FF00H will set the Relay on and the value 0000H will turn it off; all other values are invalid and will not affect that relay.

The example below is a request to Acuvim II series meter address 1 to turn on Relay 1.

Table 5-12 Control Relay Query Message

Transaction identifier hi	Transaction identifier lo	Protocol identifier hi	Protocol identifier lo	Length hi	Length lo	Unit identifier
00H	00H	00H	00H	00H	06H	01H
Fun	Data start reg hi	Data start reg lo	Value hi	Value lo		
05H	00H	00H	FFH	00H		

Response

The normal response to the command request is to retransmit the message as received after the Relay status has been altered.

Table 5-13 Control Relay Response Message

Transaction identifier hi	Transaction identifier lo	Protocol identifier hi	Protocol identifier lo	Length hi	Length lo	Unit identifier
00H	00H	00H	00H	00H	06H	01H

Fun	Data start reg hi	Data start reg lo	Value hi	Value lo
05H	00H	00H	FFH	00H

e. Preset/Reset Multi-Register (Function Code 16)

Query

Function code 16 allows the user to modify the contents of a Multi-Register. The example below is a request to an Acuvim II series meter address 1 to Preset CT1 (500) and CT2 (5). CT1 data address is 1008H, and CT2 data address is 1009H.

Table 5-14 Preset CT Value Query Message

Transaction identifier hi	Transaction identifier lo	Protocol identifier hi	Protocol identifier lo	Length hi	Length lo	Unit identifier
00H	00H	00H	00H	00H	0BH	01H

Fun	Data start reg hi	Data start reg lo	Data #of regs hi	Data #of regs lo	Byte count	Value1 hi	Value1 lo	Value2 hi	Value2 lo
10H	10H	08H	00H	02H	04H	01H	F4H	00H	05H

Response

The normal response to a preset Multi-Register request includes MBAP Header, function code, data start register and the number of registers.

Table 5-15 Preset Multi-Registers Response Message

Transaction identifier hi	Transaction identifier lo	Protocol identifier hi	Protocol identifier lo	Length hi	Length lo	Unit identifier
00H	00H	00H	00H	00H	06H	01H

Fun	Data start reg hi	Data start reg lo	Data #of regs hi	Data #of regs lo
10H	10H	08H	00H	02H

Users may refer to the sixth chapter “Communication” and get the details of Acuvim II series meter.

When using Modbus/TCP function, it is best to set the Scan interval of the software to under 1000 ms.

When using Third Party software, it is best to set Frame interval for the Modbus-TCP function to under 1000 ms.

5.2.11 Webpage Browsing and Parameter Settings

The Ethernet module supports HTTP protocol and has a Web Server function making the Acuvim II series meter accessible through Ethernet at anytime from anywhere.

The Ethernet module supports IE Browser 6.0 and higher editions and the Webpage Settings only support ASCII characters.

The IP address will be referred to as "192.168.1.200" for the remainder of this chapter.

1. Main page

Users enter the correct IP address and HTTP port of the module in the address bar of the web browser. This provides access to "Data", "Settings" and "Module Status".

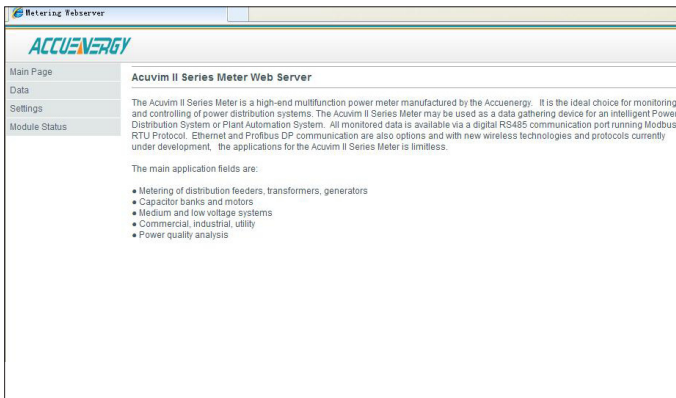

Fig 5-42

2. Module Status Webpage

By selecting the "Module Status" link, users can view the status and change the settings of the Ethernet module.

Metering Webserver			
ACCUENERGY			
Main Page			
Data			
Settings			
Module Status			
Device Description	Acuvin II	Mail From	Acuvin II
DHCP Mode	MANUAL	Mail to #1	abc@accuenergy.com.cn
IP Address	192.168.1.43	Mail to #2	
Subnet Mask	255.255.255.0	Mail to #3	
Gateway	192.168.1.1	Subject	Metering
DNS Primary	192.168.1.4	SMTP Server	mail.accuenergy.com.cn
DNS Secondary	192.168.1.167	User Name	test@accuenergy.com.cn
MODBUS Port	502	Triggered Sending	Alarm Event, SOE Event.
HTTP Port	80	Timed Sending	60min
MAC Address	ec-c3-8a-00-0e-ee	Mail Content	Metering, Energy, Harmonics, Sequence, Max/Min, Alarm Record, SOE Record.
Meter Model	Acuvin IIR	Meter SN	ATR1005089
Meter Firmware	2.22	NET Firmware	2.20
Default Frequency	50Hz	Device Clock	2012-8-19-18-45-48

Fig 5-43

3. Settings Webpage

By selecting the "Settings" link, users can access "Network Settings", "Mail Settings", "Webpage Settings", "Management" and "Password Setting".

When accessing the "Settings" link, users will be prompted to enter a password. The default password is 12345678.

a. "Password" Webpage

Fig 5-44: "Password" webpage. If the password is valid, the browser will go to the "Network Settings" webpage. If an incorrect password is used, users will be notified of "Invalid Password".

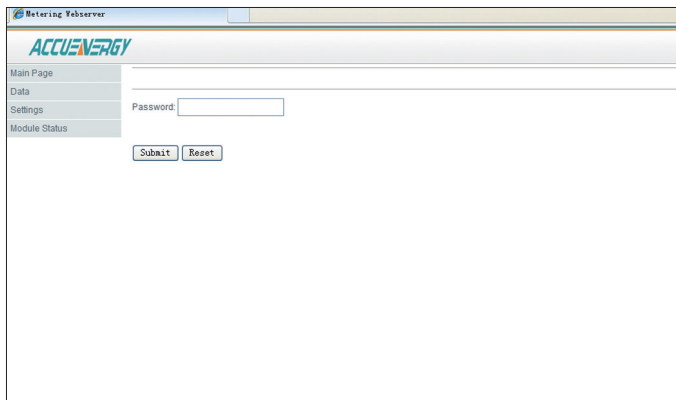

Fig 5-44

b. "Network Settings" Webpage

Fig 5-45: "Network Settings" webpage. There are three sections for you to set: Ethernet setting, SNMP setting and SNMP trap setting. In Ethernet setting section, it supports two network setting modes: Manual or Auto. There are two port settings: HTTP port and Modbus-TCP port.

The default value of Modbus-TCP port is 502, and the user defined range is 2000~5999. The default value of HTTP port is 80, and the user defined range is 6000~9999.

In SNMP setting section, there are four contents:

- SNTP Enable, enable SNTP function.
- SNTP Interval, setup interval seconds which SNTP client check SNTP server. The default value is 10min, and the user defined range is 1-60000min.
- SNTP Server, setup SNTP Server which SNTP client update from. Please find available SNTP server from internet.
- Time Zone Selecting: select Time Zone which matches your location.

Metering Webserver x

ACCUNET

Main Page
Data
Settings
Module Status

Network Parameter Configuration

Manual Setting Auto Setting

Network Parameter:

IP Address: 192 . 168 . 1 . 254 (Example: 192.168.1.254)

Subnet Mask: 255 . 255 . 255 . 0 (Example: 255.255.255.0)

Gateway: 192 . 168 . 1 . 1 (Example: 192.168.1.1)

DNS Primary Server: 202 . 106 . 0 . 20 (Example: 202.106.0.20)

DNS Secondary Server: 0 . 0 . 0 . 0 (Example: 202.106.196.115)

Port Setting:

MODBUS Port: 502 (Default: 502, Scope: 2000-9999)

HTTP Port: 80 (Default: 80, Scope: 6000-9999)

SNTP Setting: (Please restart AXM-NET Module after SNTP setting.)

SNTP Enable

SNTP Interval: 10 min(Default: 10, Scope: 1-60000)

SNTP Server: time.windows.com

Time Zone Selecting:
(UTC-12:00) International Date Line West

Fig 5-45

c. "Mail Settings" Webpage

Fig 5-46: "Mail Settings" webpage. Users can choose between 4 mail sending modes: "Triggerd Sending", "Timed Sending", both "Triggered and Timed Sending" and "None". Boxes marked with "*" cannot be left blank. "Triggered Sending" means users will receive mail when the meter detects a new event, such as an "Alarm Event" or "SOE Event". "Timed Sending" means users can receive mail every 5~1440 minutes (user settable) reporting "Metering", "Energy", "Harmonics", "Sequence", "Max/Min", "Alarm Record" and "SOE Record".

Sending Modes can be set as follows:

Setting "Triggered Sending" mode: users can select one or all of the checkboxes below. Triggered Sending includes "Alarm Event" and "SOE Event" as seen in Fig 5-46. Triggered Sending mode is disabled if neither "Alarm Event" or "SOE Event" is selected.

Setting "Timed Sending" mode: users enter a number between 5 and 1440 minutes into the box beside "Timed Sending". This number is the interval time between mail. Sending mode is disabled if 0 is entered. Users can also select which parameters to receive reports on by checking the checkboxes below "Timed Sending" in Fig 5-46. Setting both "Triggered Sending" and "Timed Sending" mode: users follow the steps for both "Triggered Sending" and "Timed Sending" above.

"None" mode: users disable both "Triggered Sending" and "Timed Sending" modes.

Note: Mail Server part includes "SMTP Server", "User Name" and "Password". For the "SMTP Server" users can input either domain name such as "mail.acuenergy.com" or an IP address such as "222.128.6.73" which is from "mail.acuenergy.com" resolved. A user name and password will be required to log in.

Metering Webserver

ACCURENERGY

Main Page
Data
Settings
Module Status

Mail Information

Mail From: * (Example: Technical Support)

Mail To #1: * (Example: abo@accuenergy.com)

Mail To #2: (Example: abo@gmail.com)

Mail To #3: (Example: abo@yahoo.com)

Subject: * (Example: test mail)

Mail Server

SMTP Server: *

User Name: *

Password: *

Mail Content

Triggered Sending:

Alarm Event SOE Event

Timed Sending: min * (Time Scope: 5 ~1440min, 0 for disable)

Metering Energy Harmonics Sequence Max and Min Alarm Record SOE Record

Fig 5-46

d. "Web Configuration Settings" Webpage

Fig 5-47: "Webpage Settings" page. Users set the "Device Description" according to the meter type.

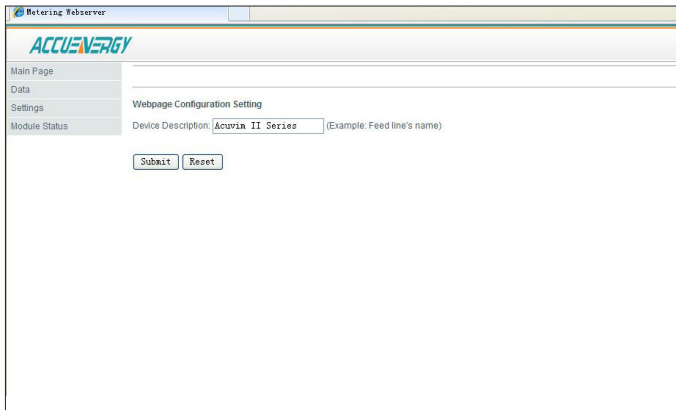

Fig 5-47

e. "Management" webpage

Fig 5-48: "Management" webpage. Users can easily update the software online by selecting the updated file, which can be got from Accuenergy Corporation. The "Reboot NET module" option resets the module itself. When selecting "Load Default Setting", it will show as follows:

IP Address:192.168.1.254

Subnet Mask:255.255.255.0

Gateway:192.168.1.1

DNS Primary: 202.106.0.20

DNS Secondary: 202.106.196.115

MODBUS Port: 502

HTTP Port: 80

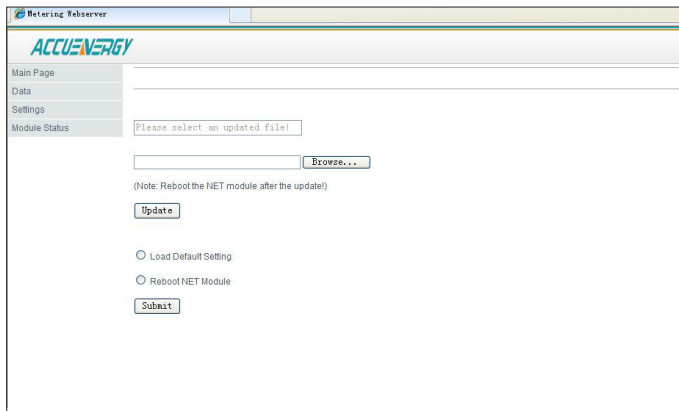
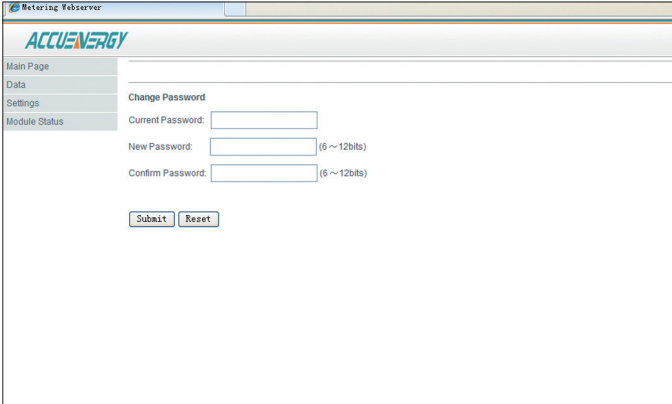

Fig 5-48

f. "Password Setting" Webpage

Fig 5-49: "Password Setting" webpage. To change the password, users need to input the current password first.



The screenshot shows a web browser window titled "Metering Febserver". The page header features the "ACCUENERGY" logo. A left-hand navigation menu includes links for "Main Page", "Data", "Settings", and "Module Status". The main content area is titled "Change Password" and contains three input fields: "Current Password:", "New Password:", and "Confirm Password:". Each field is followed by a note "(6 ~ 12bits)". Below the input fields are two buttons: "Submit" and "Reset".

Fig 5-49

4. Data Webpage

Click "Data" Link to Visit Data webpages. There are eight kinds of data webpages. They are "Metering" webpage, "Energy" webpage, "Harmonics" webpage, "Sequence" webpage, "Max and Min" webpage, "Alarm Record" webpage "SOE Record" webpage and "IO Status" webpage. Each webpage shows the working status of the meter.

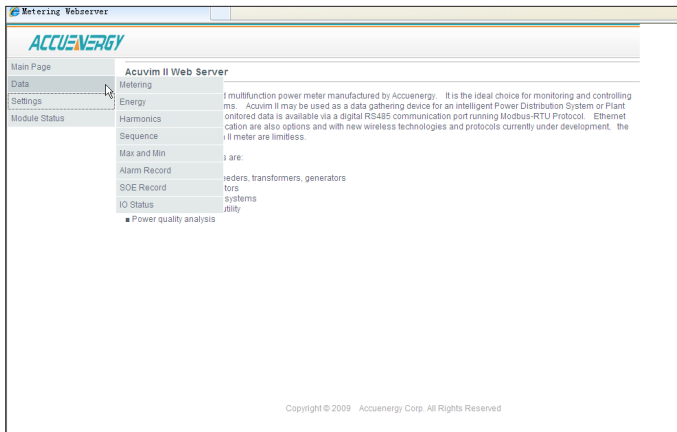

Fig 5-50

"Metering" webpage includes the data of real-time parameters for Acuvim II series meter. There are thirty nine parameters, such as Volts AN, I A, Watt A.

"Energy" webpage includes the energy data for Acuvim II series meter. There are twenty-four parameters, such as Delivered kWh, kVAh.

"Harmonics" webpage includes harmonics parameters for Acuvim II series meter, such as THD Volts Average.

"Sequence" webpage includes the sequence and angle parameters for Acuvim II series meter. There are fifteen parameters, such as positive sequence of VA, the angle VB to VA.

"Max and Min" webpage includes the max and min data of parameters for Acuvim II series meter. There are twenty-five parameters, such as Volts AN, I A , and Watt Total (Demand).

"Alarm Record" webpage includes alarm records for Acuvim II series meter. There are sixteen records. Each record includes Time Stamp, Limit ID, Status, Alarm Channel and Value.

"SOE Record" webpage includes SOE record for Acuvim II series meter. There are twenty records. Each record includes Time Stamp, DI Status.

"IO Status" webpage includes DI status or DI counters, DO status, RO status, Analog Input values and Analog Output values.

5.2.12 Email Function

The Ethernet module supports SMTP protocol, which provides email capabilities. Before sending emails, users must set their own DNS Server. Please refer to "Network settings" which includes DNS Server setting.

Please note, as per 3.c of Section 5.2.11, there are four modes users can select. The first is "Triggered Sending", which means once new events happen, users can receive email notifications immediately. The second is "Timed Sending" mode. Users can receive emails based on preset time intervals (5~1440 minutes), which include all information on "Data" webpage. The third mode is a combination of "Triggered Sending" and "Timed Sending". The fourth mode is disable both "Triggered Sending" and "Timed Sending".

5.2.13 SNTP Function

Ethernet communication supports SNTP (Simple Network Time Protocol) protocol, so meters can get update time to Coordinated Universal Time (UTC). Please find the SNTP Settings – Network Settings by Internet Explorer.



The screenshot shows a configuration window for SNTP settings. It contains the following elements:

- A checked checkbox labeled "SNTP Enable".
- A text field for "SNTP Interval" containing the value "10", followed by the text "min (Default: 10, Scope: 1~60000)".
- A text field for "SNTP Server" containing the value "time.windows.com".
- A label "Time Zone Selecting:" followed by a dropdown menu.
- The dropdown menu is currently set to "(UTC+08:00) Beijing, Chongqing, Hong Kong, Urumqi".

Fig 5-51

5.3 ProfiBus Module (AXM-PRO)

5.3.1 Introduction of PROFIBUS Technology

PROFIBUS (Process Field bus) is an international field bus standard which is widely used in automation technology of manufactures and flow industry. It is a widely used, open digital communication system, which is suitable for high-speed, time-critical, and high reliability communications.

PROFIBUS is one kind of open style field bus standard which is promoted by SIEMENS Corporation. In 1989, it became the German standard DIN19245, in 1996, it became the European standard EN50170, in 1999 it was accepted as part of the international standard IEC61158 and in 2001 it became the Chinese national standard JB/T 10308.3-2001 for field bus of machinery industry controlling systems.

There are 3 types of PROFIBUS: PROFIBUS-DP (Decentralized Periphery), PROFIBUS-PA (Process Automation) and PROFIBUS-FMS (Field bus Message Specification). ALL types follow the same protocol.

With optimized, high-speed, low-cost communication links, PROFIBUS-DP is especially used in automatic controlling systems and equipment level decentralized I / O communication. It can meet real-time response, stability and reliability of equipment level and distributed controlling systems.

The PROFIBUS module uses PROFIBUS-DP (V0) protocol.

5.3.2 PROFIBUS module application notes

Please read appendix of technical data and specifications of PROFIBUS module before using it. In addition, please read the communication addresses of MODBUS protocol, which are the communication addresses for the PROFIBUS

module as well.

- * The PROFIBUS module can only be used as slave in PROFIBUS network. Its slave address ranges from 0 to 126, which can only be set by the panel. If the address is changed, it will take effect immediately.
- * The PROFIBUS module's baud rate can be adaptive between 9.6Kbps to 12Mbps in PROFIBUS network.
- * The PROFIBUS module terminals should be connected properly to avoid problems during installation.
- * Please read GSD file of the PROFIBUS module carefully before using. The GSD file contains technical information such as device name, ID number and so on.
- * Please read the communication data format thoroughly as this is a key point of the PROFIBUS module.

5.3.3 Appearance and Dimensions

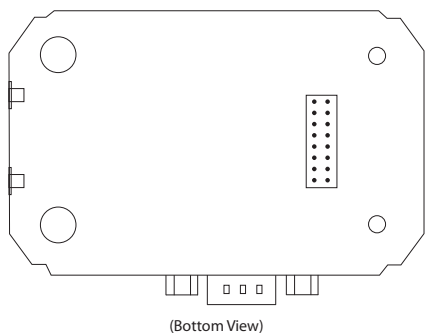
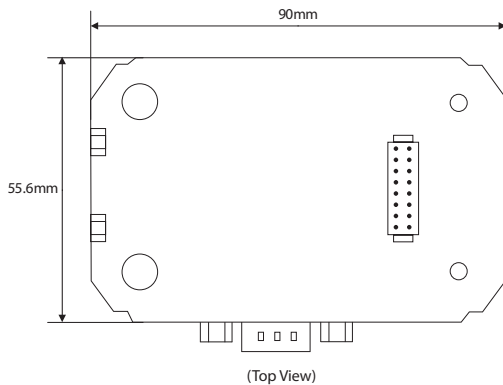

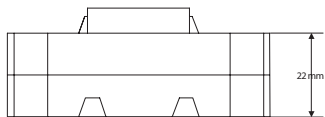

(Side View)

Fig 5-52

5.3.4 Installation Method

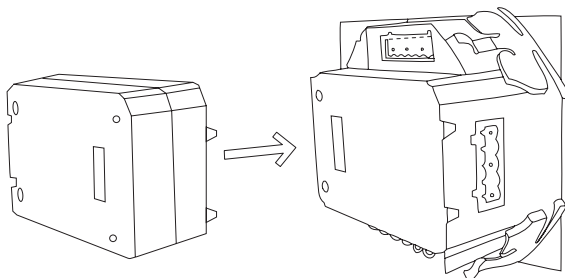

Fig 5-53

PROFIBUS is linked to Acuvim II meter by communication plug. It can also be linked to other extended modules such as IO modules.

1. Insert the installation clips to the counterpart of Acuvim II meter, and then press the PROFIBUS module lightly, so linking is established.
2. Tighten the installation screws.

Note: 1. Install IO Modules carefully to avoid damage;

2. Under no circumstances should any installation be done with the meter powered on. Failure to do so may result in injury or death.

5.3.5 Definition of DP Interface

The PROFIBUS module uses standard 9-pin D-type connector to access PROFIBUS network. The mechanical and electrical characteristics of connector are consistent with the requirements of IEC 807-3. The connector of PROFIBUS is a socket, and the counterpart connector of cable is a plug. Connector pins are distributed as follows:

Table 5-16

Pins	RS-485	ID	Content	Used by PROFIBUS
1	——	SHIELD	Power GND	NO
2	——	N24V	-24V Output	NO
* 3	B	RXD/TXD-P	Data P (Receive /Send)	YES
4	——	CNTR-P	Controlling P	YES
5	C	DGND	Digital Ground	YES
6	——	Vp	Positive Voltage	YES
7	——	P24V	+24V output	NO
8	A	RXD/TXD-N	Data N (Receive /Send)	YES
9	——	CNTR-N	Controlling N	NO

***Note:** Pin 4 is used for RTS controlling and TTL, which is optional.

5.3.6 Cable

Shielded twisted pair cable is recommended as reference to the EIA RS-485 standard. If the interference is within the EIA RS-485 standard then non-shielded twisted pair cable can may be used.

5.3.7 Bus Terminal

Based on DP standard, the first station and the last station in PROFIBUS-DP network should connect bus terminal (resistor), and it is not necessary for other stations, as shown in the figure below.

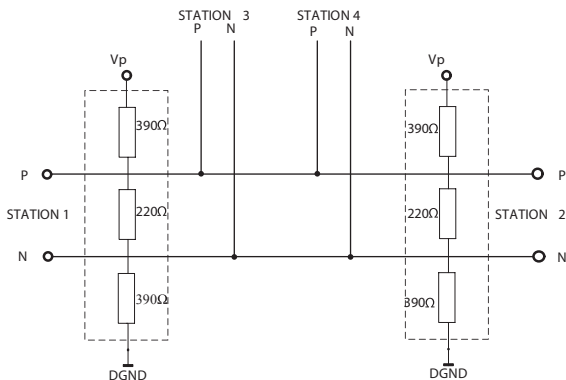

Fig 5-54

Connection of many DP stations

The bus terminal is composed of three resistors and connection wire, where V_p is the supply positive voltage and DGND is the Digital Ground. When the bus is idle, the bus terminal makes the data P level higher than data N, so the bus's idle signal is always 1.

5.3.8 Address Setting

The PROFIBUS module can only be used as a slave in the PROFIBUS network. Its slave address ranges from 0 to 126, which can only be set by the front panel of the meter (in SYS sub menu of Acuvim II Setting menu). If the address is changed, it will take effect immediately.

Figure below shows the address setting of PROFIBUS module.

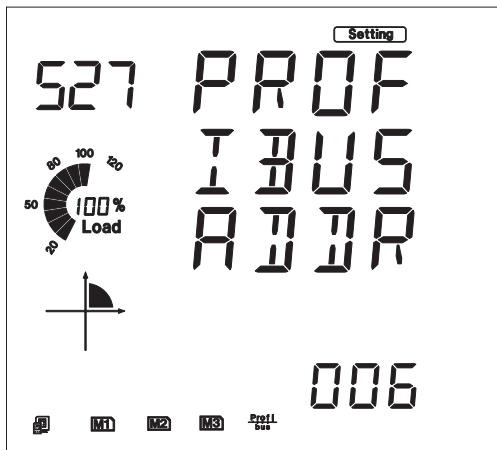

Fig 5-55 Address setting of PROFIBUS module

5.3.9 Baud Rate

The PROFIBUS module's baud rate can be adaptive between 9.6Kbps to 12Mbps in PROFIBUS network.

5.3.10 GSD Files

A PROFIBUS-DP master can exchange data with various slave devices. In order to identify a slave device, it is necessary to obtain the technical data of the device itself. The file where the data is described is called Device Description Data File (GSD).

Because of the importance of GSD file, please read it carefully before using the PROFIBUS module. The GSD file is provided in pure text format with detailed comments.

- As a DP slave device, the PROFIBUS module supports protocol of V0 revision.
- The PROFIBUS module's data interface is optional, module 1 is a 16 word input/output interface, module 2 is a 32 word input, 1 word output interface.

5.3.11 Information Exchange

A variety of information from the Acuvim II meter can be transmitted by the PROFIBUS module, such as electrical quantities and other parameters. The basic communication method of the Acuvim II meter is RS-485, which uses protocol of MODBUS-RTU. In order to use the same address lists as MODBUS-RTU, the communication formats of PROFIBUS-DP, which is 16 word input/output is categorized in the same way as MODBUS-RTU.

It is recommended to refer to the communication part of the Acuvim II manual (Chapter 6) for the list of MODBUS-RTU addresses, function codes, the relationships between values, etc. Some examples are:

1. There are various function codes, such as 01H, 02H, 03H, 05H, 10H, for the various categorized parameters. Different function codes have different formats of query and response frames.

2. There is a specific relationship between numerical value in register of Acuvim II meter and the real physical value.
3. Different parameters may have different data length and data type.

These three points are also suitable for the PROFIBUS-DP protocol in PROFIBUS module.

Note: the following “communication formats” are suitable for the application data, but not for the PROFIBUS-DP’s frame characteristic data.

Function codes, such as 01H, 02H and 03H, are inquiry commands. For users to quickly switch the inquiry contents, we define 8 channels named 1 to 8, in order to update data more quickly.

5.3.12 Format of function code 01H

Function code 01H is used to read relay status in MODBUS-RTU. In PROFIBUS-DP, the format of function code 01H is defined as follows:

Query:

Table 5-17

Frame Bytes	Caption
Byte1	Channels can be chosen from 1 to 8
Byte2	01H
Byte3	starting address high byte
Byte4	starting address low byte
Byte5	quantity of coils high byte
Byte6	quantity of coils low byte
Byte7~32	0

Because 16 words are required for IO data in GSD file, all other bytes after Byte7 are set to 0.

Response

Below is the response that a slave device would send to a master.

Table 5-18

Frame Bytes	Caption
Byte1	The channel of inquiry frame
Byte2	01H
Byte3	byte count
Byte4	coil status
Byte5~32	0

The coils in the response message are packed as one coil per bit of the data field. Status is indicated as 1=ON and 0=OFF. The LSB of the first data byte contains the output addressed in the query. The other coils follow toward the high order end of this byte, and form low order to high order in subsequent bytes.

Example: reading Relay1 and Relay2 status (start register address is 0000H). Use 4 channels.

Table 5-19

Query

Byte1	Byte2	Byte3	Byte4	Byte5	Byte6	Byte7~32
04H	01H	00H	00H	00H	02H	00H

Response

Byte1	Byte2	Byte3	Byte4	Byte5	Byte6	Byte7~32
04H	01H	01H	02H	00H	00H	00H

Coil Status

7	6	5	4	3	2	1	0
0	0	0	0	0	0	1	0

MSB
(Relay 1 = OFF, Relay 2=ON)

LSB

5.3.13 Format of function code 05H

The message with function code (05H) in MODBUS-RTU forces a single relay either on or off. The data value FFOOH will set the relay on and the value 0000H will turn it off. All other values are invalid and will not affect that relay.

In PROFIBUS-DP, the format of function code 05H is defined as follows:

Query

Table 5-20

Frame Bytes	Caption
Byte1	FAH
Byte2	05H
Byte3	outputs address high byte
Byte4	outputs address low byte
Byte5	outputs value high byte
Byte6	outputs value low byte
Byte7~32	0

Note: Because PROFIBUS-DP V0 exchanges information data periodically, controlling information such as function code 05H should be used carefully.

Response

The normal response to the command request is to retransmit the message as received after the relay status has been altered.

Table 5-21

Frame Bytes	Caption
Byte1	FAH
Byte2	05H
Byte3	outputs address high byte
Byte4	outputs address low byte
Byte5	outputs value high byte
Byte6	outputs value low byte
Byte7~32	0

Example: setting Relay2 on.

Table 5-22

Query

Byte1	Byte2	Byte3	Byte4	Byte5	Byte6	Byte7~32
FAH	05H	00H	01H	FFH	00H	00H

Response

Byte1	Byte2	Byte3	Byte4	Byte5	Byte6	Byte7~32
FAH	05H	00H	01H	FFH	00H	00H

5.3.14 Format of function code 02H

Function code 02H is used to read DI status in MODBUS-RTU. In PROFIBUS-DP, the format of function code 02H is defined as follows:

Query

Table 5-23

Frame Bytes	Caption
Byte1	Channels can be chosen from 1 to 8
Byte2	02H
Byte3	starting address high byte
Byte4	starting address low byte
Byte5	quantity of digital inputs high byte
Byte6	quantity of digital inputs low byte
Byte7~32	0

Response

Table 5-24

Frame Bytes	Caption
Byte1	The channel of inquiry frame
Byte2	02H
Byte3	byte count
Byte4	inputs status1

Byte5	inputs status2 (or 0)
Byte6	inputs status3 (or 0)
Byte7	inputs status4 (or 0)
Byte8~32	0

The digital inputs in the response message are packed as one input per bit of the data field. Status is indicated as 1=ON; 0=OFF. The LSB of the first data byte contains the input addressed in the query. The other inputs follow toward the high order end of this byte, and from low order to high order in subsequent bytes.

Example: reading 4 DI statuses (starting address is 0000H). Use 6 channels.

Table 5-25

Query

Byte1	Byte2	Byte3	Byte4	Byte5	Byte6	Byte7~32
06H	02H	00H	00H	00H	04H	00H

Response

Byte1	Byte2	Byte3	Byte4	Byte5~32
06H	02H	01H	06H	00H

DI status

7	6	5	4	3	2	1	0
0	0	0	0	0	1	1	0

MSB LSB

(D11 = OFF, DI2=ON, DI3 = ON , DI4 = OFF)

5.3.15 Format of function code 03H

This function code is used in MODBUS-RTU to read the contents of a continuous block of holding registers in Acuvim II meter. In PROFIBUS-DP, the format of function code 03H is defined as follows:

Table 5-26

Query

Frame Bytes	Caption
Byte1	Channels can be chosen from 1 to 8
Byte2	03H
Byte3	starting address high byte
Byte4	starting address low byte
Byte5	quantity of registers high byte
Byte6	quantity of registers low byte
Byte7~32	0

“Quantity of registers” identifies how many words will be read.

Table 5-27

Response

Frame Bytes	Caption
Byte1	The channel of inquiry frame
Byte2	03H
Byte3	byte count
Byte4	Register value1 high byte
Byte5	Register value1 low byte
Byte6
Byte32

“Byte count” identifies how many bytes will be read.

The register data in the response message is packed as two bytes per register,

with the binary contents correctly justified with each byte. For each register, the first byte contains the high order bits and the second contains the low order bits.

It is important to note: The response has a 16-word frame. so the maximum “quantity of registers” should less than 15. Otherwise, it will return an error result.

Example: reading 3 measured data (F,V1,V2) from Acuvim II meter. The data address of F includes 4000H and 4001H. The data address of V1 includes 4002H and 4003H. The data address of V2 includes 4004H and 4005H. (Use 7 channels)

Table 5-28

Query

Byte1	Byte2	Byte3	Byte4	Byte5	Byte6	Byte7~32
07H	03H	40H	00H	00H	06H	00H

Response

Byte1	Byte2	Byte3	Byte4	Byte5	Byte6	Byte7	Byte8
07H	03H	0CH	42H	48H	00H	00H	42H
Byte9	Byte10	Byte11	Byte12	Byte13	Byte14	Byte15	Byten16~32
C7H	CCH	CDH	42H	C8H	33H	33H	00H

(F=42480000H(50.00Hz), V1=42C7CCCDH(99.9v), V2=42C83333H(100.1v)).

Note: The relationship between the numerical value in the register of the meter and the actual physical value is described in detail in Chapter 6.

5.3.16 Format of function code 10H

This function code is used in MODBUS-RTU to write a block of continuous registers in the Acuvim II meter, such as system parameters setting and so on. In PROFIBUS-DP, the format of function code 10H is defined as follows:

Table 5-29

Query

Frame Bytes	Caption
Byte1	FAH
Byte2	10H
Byte3	starting address high byte
Byte4	starting address low byte
Byte5	quantity of registers high byte
Byte6	quantity of registers low byte
Byte7	byte count
Byte8	register value 1 high byte
Byte9	register value 1 low byte
Byte10	register value 2 high byte
Byte11	register value 2 low byte
.....
Byte32	0

“Quantity of registers” indicates how many words will be written.

“Byte count” indicates how many bytes will be written. If “quantity of register” is N, then “byte count” is (N×2).

It is important to note: the response has a 16-word frame, so the maximum “quantity of registers” should be less than 13. Otherwise it will return an error result.

Response

The normal response returns the function code, starting address, and quantity of registers written.

Table 5-30

Frame Bytes	Caption
Byte1	FAH
Byte2	10H
Byte3	starting address high byte
Byte4	starting address low byte
Byte5	quantity of registers high byte
Byte6	quantity of registers low byte
Byte7~32	0

Example: presetting import active energy (EP_imp) to 17807783.3Kwh. Based on the relationship between the register value and the physical value, we can get that the register value in hex is 0A9D4089H. The data address of EP_imp includes 4048H and 4049H.

Table 5-31

Query

Byte1	Byte2	Byte3	Byte4	Byte5	Byte6	Byte7	Byte8
FAH	10H	40H	48H	00H	02H	04H	0AH
Byte9	Byte10	Byte11	yte12~32				
9DH	40H	89H	00H				

Response

Byte1	Byte2	Byte3	Byte4	Byte5	Byte6	Byte7~32
FAH	10H	40H	48H	00H	02H	00H

Example Projects

To facilitate your understanding of the PROFIBUS module, we have developed a PLC-based DEMO engineering application program. Please read DEMO procedure documentation for the specific information. This DEMO is available upon request, please call Technical Support.

5.3.17 32 Word Output Interface

The 32 word output interface is fixed parameter.

Transmission format is as follows:

Ua_rms(2 bytes), Ub_rms(2 bytes), Uc_rms(2 bytes), Uavg_rms(2 bytes);

Uab_rms(2 bytes), Ubc_rms(2 bytes), Uca_rms(2 bytes), Ulag_rms(2 bytes);

Ia_rms(2 bytes), Ib_rms(2 bytes), Ic_rms(2 bytes), Iavg_rms(2 bytes);

Pa_rms(2 bytes), Pb_rms(2 bytes), Pc_rms(2 bytes), Pavg_rms(2 bytes);

Epa_imp(4 bytes), Epa_exp(4 bytes);

Epb_imp(4 bytes), Epb_exp(4 bytes);

Epc_imp(4 bytes), Epc_exp(4 bytes);

Ep_imp(4 bytes), Ep_exp(4 bytes);

5.4 RS485 Module (AXM-485)

5.4.1 Communication Parameters Setting

RS485, also known as EIA-485, is a telecommunications standard for binary serial communications between devices. RS485 is the most versatile communication standard in the standard series defined by the EIA, and it is currently a widely used communication interface in data acquisition and control applications where multiple nodes communicate with each other.

The RS485 signals are floating and each signal is transmitted over a differential signal + line and a differential signal - line. The RS485 receiver compares the voltage difference between both lines, instead of the absolute voltage level on a signal line. If the differential signal + and differential signal - lines are twisted, better communication performance can be achieved. The twisted pair adds immunity to fight noise. If high noise immunity is needed, often a combination of twisting and shielding is used. For example, shielded twisted pair or foiled twisted pair networking cables.

5.4.2 Function Description of RS485 module

AXM-RS485 module uses RS485 serial communication and the Modbus-RTU protocol, just like the onboard RS485 port of the Acuvim II series meter. It provides a second RS485 port for serial communication, and it can be working with the onboard RS485 serial communication simultaneously.

The terminals of communication are A, B, and S. A is differential signal +, B is differential signal -, and S is connected to the shield of the twisted pair cables.

- Up to 32 devices can be connected on a RS485 bus without repeaters.

- Use good quality shielded twisted pair cable, AWG22 (0.5mm²) or higher.
- The overall length of the RS485 cable connecting all devices should not exceed 1200m (4000ft).
- Every A(+) should be connected to A(+), B(-) to B(-), or it will influence the network, or even damage the communication interface.
- When using a long communication cable to connect several devices, an anti-signal reflecting resistor (typical value 120Ω-300Ω/0.25W) is normally added to the end of the cable beside the last meter if the communication quality is distorted.

5.4.3 Appearance and Dimensions

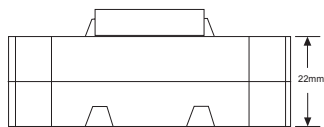

(side view)

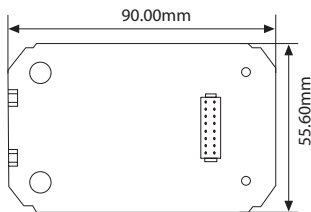

(top view)

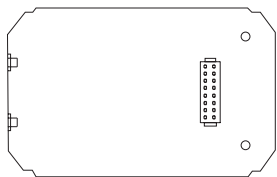

(bottom View)
Fig 5-56

5.4.4 Installation Method

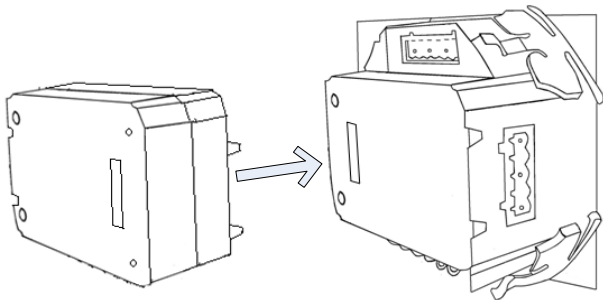

Fig 5-57

The RS485 module is linked to the meter by a communication plug. It also can be linked to other extended modules.

- 1.Insert the installation clips to the counterpart of the meter, and then press the RS485 module lightly, so linking is established.
- 2.Tighten the installation screws.

Note:

1. Install AXM-RS485 Module carefully to avoid damage;
2. Under no circumstances should any installation be done with the meter powered on. Failure to do so may result in injury or death.

5.4.5 Connection Method

The RS485 module is using 2-wire, half-duplex communication mode, which is the same as the one the onboard RS485 port is using. If the master does not have RS485 communication port, a converter (such as a RS232/RS485 or a USB/RS485 converter) will be required. Typical RS485 network topologies include line, circle and star. The shield of each segment of the RS485 cable must be connected to the ground at one end only.

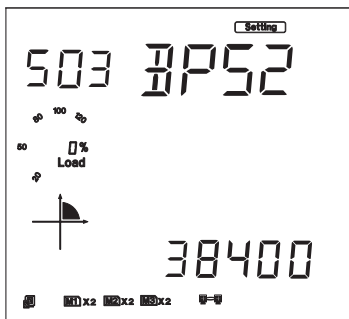

Fig 5-58

The default baud rate of RS485 module is 38400 bps. Users can change the baud rate in system settings S03 of the Acuvim II series meter.

The data format is start bit + 8n data bit + parity + stop bit. NON1, NON2, odd and even can be selected for parity mode on S32 of Setting page of Acuvim IIR and Acuvim IIE meter (Not support Acuvim II meter). NON1 represents non-parity, single stop bit; NON2 represents non-parity, double stop bit; odd represents odd-parity, single stop-bit; even represents even parity, single stop bit; As is shown, the RS485 module's parity is set as None 2.

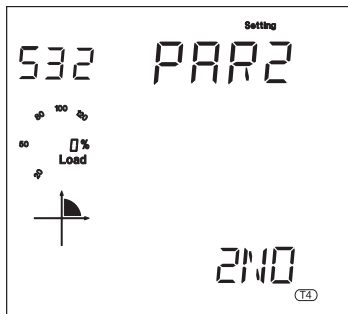

Fig 5-59

Please note: If AXM-NET is used, RS-485 module's parity (PAR2) must be set as None1 in order to have the meter recognize the AXM-NET.

5.4.6 Communication Address

Please refer to Chapter 6 for Modbus register addresses.

5.5 BACnet Module (AXM-BACnet)

5.5.1 BACnet Overview

The Building Automation and Control Network (BACnet), described in the ANSI/ASHRAE Standard 135-1995, is one of the most widely used building management systems protocols.

BACnet was designed to allow communication of building automation and control systems for applications such as heating, ventilating, and air-conditioning control, lighting control, access control, and fire detection systems and their associated equipment. The BACnet protocol provides mechanisms for computerized building automation devices to exchange information, regardless of the particular building service they perform.

5.5.2 Introduction

The Acuvim II Series Power Meter has embedded BACnet IP communication, and also has embedded BACnet MS/TP communication. It communicates in native BACnet IP over Ethernet to seamlessly integrate with most building automation/control systems, and communicating with the BACnet MS/TP via the RS485. The Acuvim II Series Power Meter's BACnet IP and BACnet MS/TP has 56 predefined BACnet objects that let you track up to 56 measurements.

The Acuvim II Series Power Meter has native BACnet/IP that lets it act as a BACnet server in any BACnet application. The Acuvim II Series Power Meter's BACnet IP also comes with a Web interface that is very easy to browse the parameter data by using a standard browser.

5.5.3 About BACnet Protocol

BACnet operates in a client-server environment. A client machine sends a service request (message) to a server machine; once the service is performed

the results are reported back to the client machine. BACnet defines 5 groups (or classes) of 35 message types. For example, one class contains messages for retrieving and manipulating the object properties described above. An example of a common service request in this class is "ReadProperty." When the server machine receives this message from a client machine, it locates the requested property of the requested object and sends the value to the client.

The BACnet protocol consists of Objects that contain different kinds of information. Each Object has properties that contain data related to it. Below is the example of an Object for Total Watts:

Object_Name, P_rms

Object_Type, AnalogValue

Object_Instance, 17

Present_Value, watt, tot (value in watts)

For more detailed information, visit the BACnet website at www.bacnet.org.

5.5.4 Using the AcuVim II Series Power Meter's BACnet

Serial and Ethernet versions

There are a couple of different serial and Ethernet based-versions of BACnet. The most common serial version is called BACnet MS/TP while the dominant Ethernet version is BACnet/IP.

BACnet/IP has been developed to allow the BACnet protocol to use TCP/IP networks. You could say that BACnet/IP is a way of hooking BACnet up to the Internet and communicate with different Local Area Networks (LANs). This enables system owners, facility managers, or even external suppliers to access BACnet networks and manage their devices and systems remotely.

Table 5-32

BACnet MS/TP facts	
Network Type	Serial RS-485 with a Master/Slave Token Passing protocol
Topology	Line topology
Installation :	Any cable with at least 3 conductors can be used. Distance between nodes depends on baud rate.
Speed	9600 kbit/s, 19200 kbit/s, 38400 kbit/s and 76800 kbit/s
max. Stations:	127 MS/TP masters
Data	Up to 480 bytes per telegram frame

Table 5-33

BACnet MS/TP facts	
Network Type	Ethernet based network using UDP for data transfer.
Topology	Line or star topology (Standard Ethernet topology)
Installation :	Ethernet twisted pair cables with RJ45 connectors
Speed	10/100 Mbit/s full duplex
max. Stations:	No network limitation of number of nodes.
Data	Up to 1476 bytes per frame

5.5.5 Using The BACnet Module (AXM-BACnet)

1. Installation Method

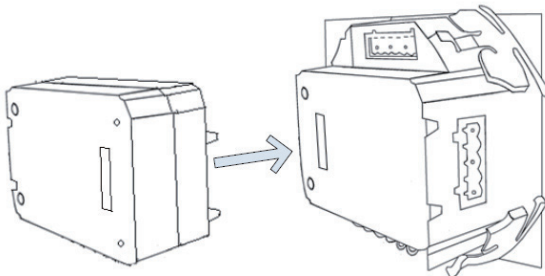

Fig 5-60

The BACnet module is linked to the Acuwin II meter by a communication plug. It can also be linked to other extended modules like IO modules.

1) Insert the installation clips to the counterpart of the meter, and then press the BACnet module lightly, so linking is established.

2) Tighten the installation screws.

Note:

- 1) Install BACnet Module carefully to avoid damage;
- 2) Under no circumstances should any installation be done with the meter powered on. Failure to do so may result in injury or death.

2. Definition of RJ45 Interface and 485 Interface

The BACnet/IP module uses a standard RJ45 connector to access the network. The mechanical and electrical characteristics of the connectors comply with the requirements of IEC 603-7.

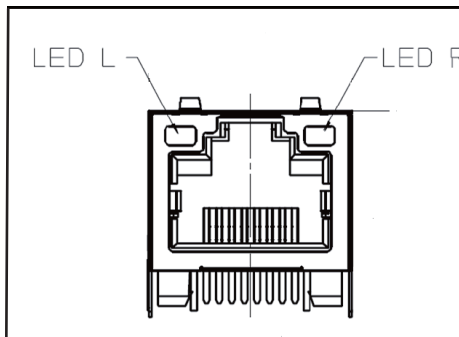

Fig 5-61

Table 5-34

Script	ID	Content
1	TX+	Tranceive Data+
2	TX-	Tranceive Data-
3	RX+	Receive Data+
4	n/c	Not connected
5	n/c	Not connected
6	RX-	Receive Data-
7	n/c	Not connected
8	n/c	Not connected

The BACnet MS/TP module uses a standard 485 connector to access the network.

#	Item
1	Network Status LED
2	Module Status LED
3	BACnet connector

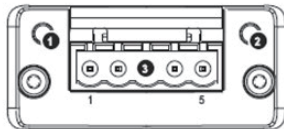

BACnet Connector

Table 5-35

Pin number	Name	Description
1	Common	Signal common
2	Data-	Negative RS485 RxD/TxD
3	Shield	Cable shield
4	Data+	Positive RS485 RxD/TxD
5		not used

3. Initializing Ethernet Module

1) BACnet Module Enable Set

When the module is first used by user, the information can be found by using

the keys on the meter front. The following process shows how to configure BACnet module settings by using the front panel:

The initial structure module parameter steps:

a) Pressing "H" key and "V/A" key simultaneously on the meter will go to the menu selecting mode. Cursor "Meter" flashes in this mode.

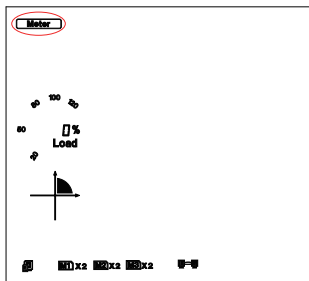

Fig 5-62

b) Press "P" key or "E" key to move the cursor to "Setting". Press "V/A" key to go to the meter parameter setting mode. Device address page is the first page of "Setting" mode. It shows the Modbus address of the device for several seconds, and then the screen goes to Access Code page. Press "V/A" key to go to the parameter setting page. Press "P" key or "E" key to move the cursor to "SYS". Press "V/A" key to go to the system setting page.

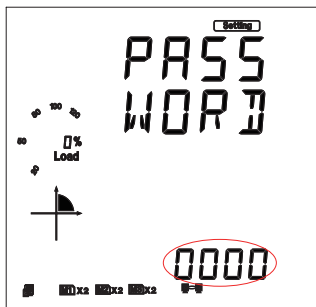

Fig 5-63

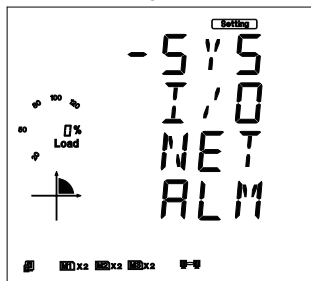

Fig 5-64

c) Press "V/A" key to go to the System setting page. The initial page is S01 the meter address page. Press "P" key or "E" key to move to S34 page .Then press "V/A" key to go to the BACnet protocol enable setting page. Press "P" key or "E" key to select configuration mode, press "V/A" key to accept and complete.

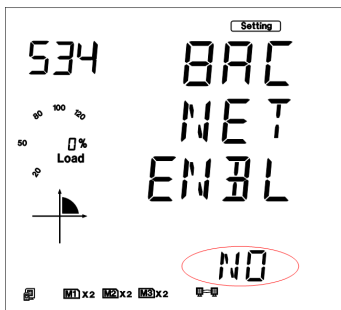

Fig 5-65

2) BACnet/IP module set

BACnet/IP Module's default settings are as follows:

IP Address (0.0.0.0); Subnet Mask (0.0.0.0); Gateway (0.0.0.0); DNS1 (0.0.0.0); DNS2 (0.0.0.0);

This information can be found by using the keys on the meter front. The following process shows how to configure BACnet module settings by using the front panel:

- a). Pressing "H" key and "V/A" key simultaneously on the meter will go to the menu selecting mode. Cursor "Meter" flashes in this mode.

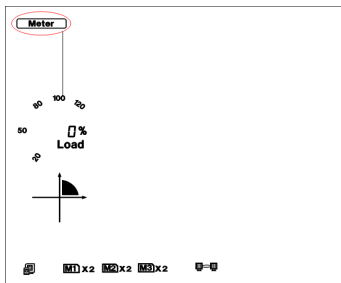

Fig 5-66

b). Press "P" key or "E" key to move the cursor to "Setting". Press "V/A" key to go to the meter parameter setting mode. Device address page is the first page of "Setting" mode. It shows the Modbus address of the device for several seconds, and then the screen goes to Access Code page. Press "V/A" key to go to the parameter setting page. Press "P" key or "E" key to move the cursor to "NET". Press "V/A" key to go to the BACnet module setting page.



Fig 5-67

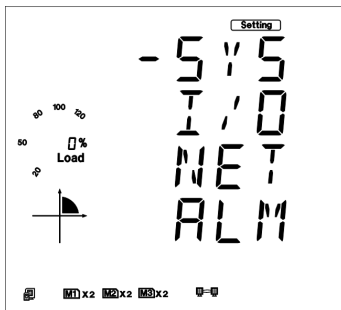

Fig 5-68

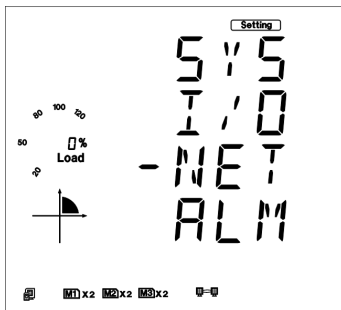

Fig 5-69

c). Set configuration mode in the first setting page. "AUTO" means that users configure module settings with DHCP protocol while "MANU" means that users configure module settings with manual setting. Press "V/A" key, to go to the setting state and the area pointed out in Fig 5-77 will flash. Press "P" key or "E" key to select configuration mode, press "V/A" key to accept. Press the "P" key again to go to the second setting page for IP Address.

Note: If you select the "AUTO" mode, please go to step 10 directly and reset module. Wait until the reset is finished and find the new IP address in the following step.



Fig 5-70

d). Set IP Address in the second setting page, such as 192.168.1.100 as shown below. Press the "V/A" key to go to the IP setting page. Users may set the parameters in the area pointed out in Fig 5-78. The cursor starts at the first digit. After setting the IP address press the "V/A" key to accept. Press the "P" key again to go to the third setting page for Subnet Mask.

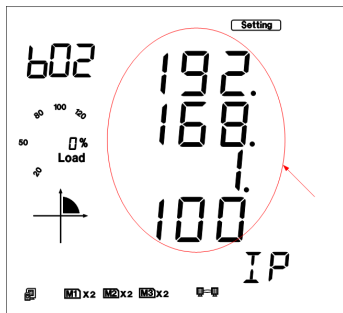

Fig 5-71

e). Set Subnet Mask in the third setting page, such as 255.255.255.0. Press "V/A" key to go to the setting page. Users may set the parameters in the area pointed out in Fig 5-79. The cursor starts at the first digit. After setting the Subnet Mask, press the "V/A" key to accept. Press the "P" key again to go to the fourth setting page for Gateway.

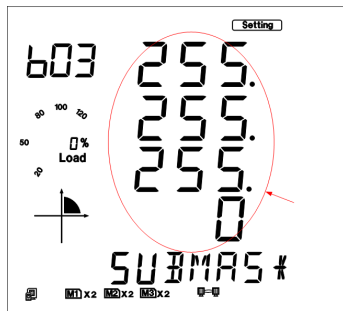

Fig 5-72

f). Set Gateway in the fourth setting page, such as 192.168.1.1. Press the "V/ A" key to go to the setting page. Users may set the parameters pointed out in Fig 5-80. The cursor starts at the first digit. After setting the Gateway, press the "V/ A" key to accept. Press the "P" key to go to the fifth setting page for DNS Primary Server.

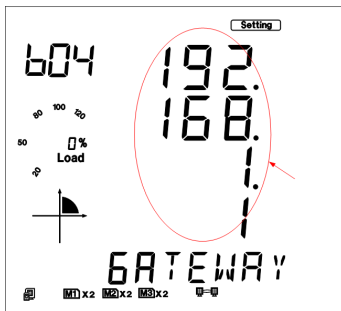

Fig 5-73

g). Set DNS Primary Server in the fifth setting page, such as 202.106.0.20. Press the "V/A" key to go to the setting page. Users may set the parameters pointed out in Fig 5-81. The cursor starts at the first digit. After setting the DNS Primary Server, press the "V/A" key to accept. Press the "P" key to go to the sixth setting page for DNS Secondary Server.

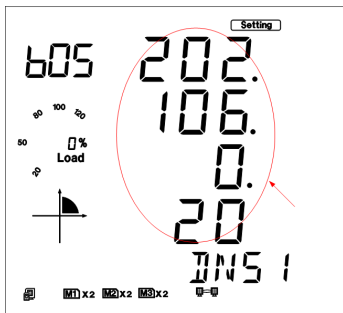

Fig 5-74

h). Set DNS Secondary Server in the sixth setting page, such as 202.106.196.115. Press the "V/A" key to go to the setting page. Users may set the parameters pointed out in Fig 5-82. The cursor starts at the first digit. After setting the DNS Secondary Server, press the "V/A" key to accept. Press the "P" key to go to the seventh setting page for the BACnet/IP port.

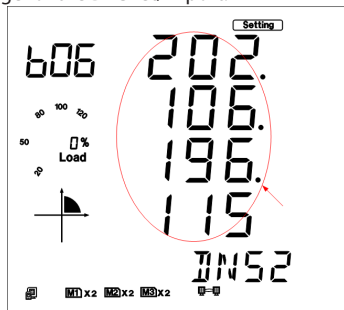

Fig 5-75

i). Set BACnet/IP port in the seventh setting page, such as 47808. Press the "V/A" key to go to the setting page. Users may set the parameters pointed out in Fig 5-83. The cursor starts at the first digit. The BACnet/IP port's default value is 47808, and the user defined range of port is 1~65535. After setting the BACnet/IP port, press the "V/A" key to accept. Press the "P" key to go to the eighth setting page for the BACnet RESET.

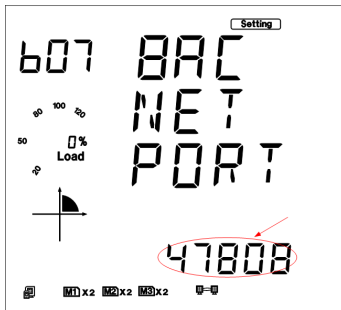

Fig 5-76

j). Set resetting mode in the eighth setting page. Select "RESET" to reset the module. Selecting "NO" will not reset the module. Press the "V/A" key to go to the setting page and the parameter pointed out in Fig 5-84 will flash. Press the "P" or "E" key to select the configuration mode. Press the "V/A" key to accept.

Note: When configuring BACnet module settings completely, users must select "RESET" to restart module and new settings will take effect.

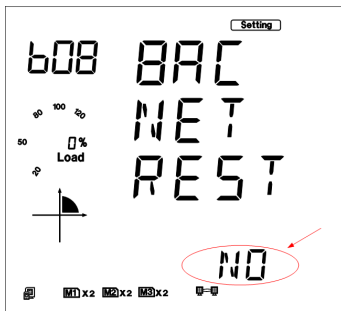

Fig 5-77

k). After configuring AXM-BACnet settings completely, press “H” key and “V/ A” key simultaneously to return to menu selecting mode.

3). BACnet MS/TP module set

BACnet MS/TP Module's default settings are as follows:

MAC Addr(0); BACnet Bps(9600); Max Info Pram(1).

This information can be found by using the keys on the meter front. The following process shows how to configure BACnet module settings by using the front panel:

a). Pressing “H” key and “V/A” key simultaneously on the meter will go to the menu selecting mode. Cursor “Meter” flashes in this mode.

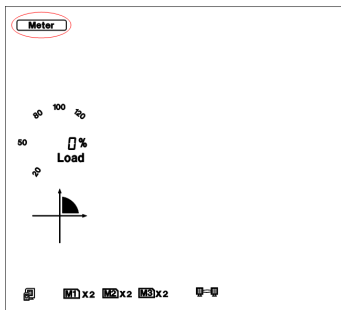

Fig 5-78

b). Press "P" key or "E" key to move the cursor to "Setting". Press "V/A" key to go to the meter parameter setting mode. Device address page is the first page of "Setting" mode. It shows the Modbus address of the device for several seconds, and then the screen goes to Access Code page. Press "V/A" key to go to the parameter setting page. Press "P" key or "E" key to move the cursor to "NET". Press "V/A" key to go to the BACnet module setting page.

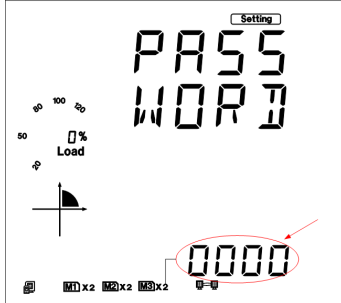

Fig 5-79

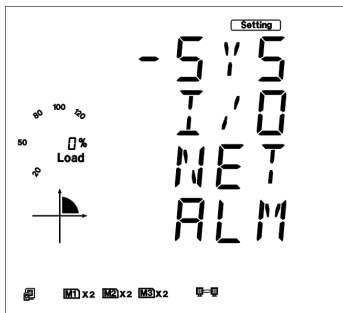

Fig 5-80

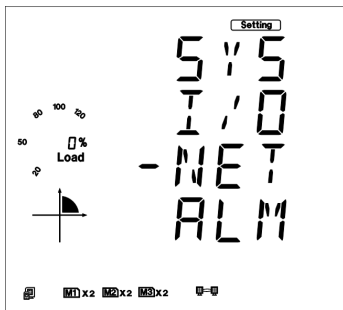

Fig 5-81

c). Set module address in the first setting page. Press the "V/A" key to go to the setting page. Users may set the parameters pointed out in Fig 5-89. The cursor starts at the first digit. The BACnet MS/TP Address's default value is 0, and the user defined range of address is 0~127. After setting the BACnet MS/TP Address, press the "V/A" key to accept. Press the "P" key to go to the second setting page for the baud rate.

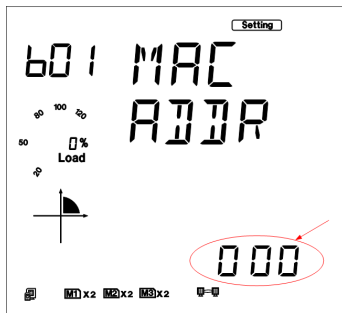

Fig 5-82

d). Set Baud Rate in the second setting page, such as 38400. The module can support the baud rate such as 9600,19200,38400,76800. Press the "V/A" key to go to the setting page. Users may set the parameters pointed out in Fig 5-90. After setting the BACnet MS/TP Baud rate, press the "V/A" key to accept. Press the "P" key to go to the third setting page for the MAX INFO FRAM.

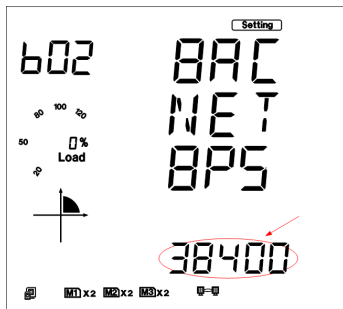

Fig 5-83

e). Set MAX INFO FRAM in the third setting page, such as 1. The BACnet MS/TP MAX INFO FRAM default value is 1, and the user defined range of MAX INFO FRAM is 1~255. Users may set the parameters pointed out in Fig 5-91. After setting the BACnet MS/TP MAX INFO FRAM, press the "V/A" key to accept. Press the "P" key to go to the fourth setting page for the module reset.

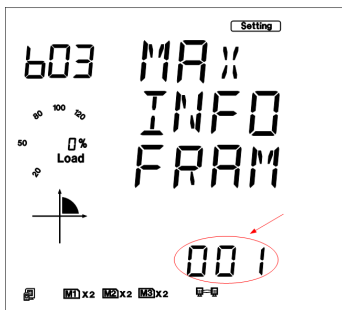

Fig 5-84

f). Set resetting mode in the fourth setting page. Select "RESET" to reset the module. Selecting "NO" will not reset the module. Selecting "RESET" will load the module with modify settings. Press the "V/A" key to go to the setting page and the parameter pointed out in Fig 5-92 will flash. Press the "P" or "E" key to select the configuration mode. Press the "V/A" key to accept.

Note: When configuring BACnet module settings completely, users must select "RESET" to restart module and new settings will take effect.

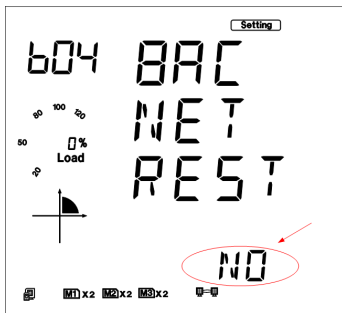

Fig 5-85

g). After configuring AXM-BACnet settings completely, press “H” key and “V/ A” key simultaneously to return to menu selecting mode.

5.5.6 Acuvim II Series Power Meter’s BACnet Objects

The Acuvim II Series Power Meter’s BACnet IP has 56 predefined objects of electrical measurements. No programming or mapping is necessary to use the BACnet objects. The object’s names easily identify the measurements they contain. All of the objects, with the exception of Modbus Meter and POLL_DELAY are AI (analog input) Object type. The following table lists each of the objects with their units of measurement and description.

Table 5-36

ObjectType	Instance	Name	Object DataType	Value	Descriptor
AnalogValue	0	Freq_rms	FLOAT	AD11	Frequency
AnalogValue	1	Ua_rms	FLOAT	AD12	Voltage A
AnalogValue	2	Ub_rms	FLOAT	AD13	Voltage B
AnalogValue	3	Uc_rms	FLOAT	AD14	Voltage C
AnalogValue	4	Uvag_rms	FLOAT	AD15	Phase Voltage Avg

ObjectType	Instance	Name	Object DataType	Value	Descriptor
AnalogValue	5	Uab_rms	FLOAT	ADI6	Voltage A-B
AnalogValue	6	Ubc_rms	FLOAT	ADI7	Voltage B-C
AnalogValue	7	Uca_rms	FLOAT	ADI8	Voltage C-A
AnalogValue	8	Ulag_rms	FLOAT	ADI9	Line Voltage Avg
AnalogValue	9	Ia_rms	FLOAT	ADI10	Current A
AnalogValue	10	Ib_rms	FLOAT	ADI11	Current B
AnalogValue	11	Ic_rms	FLOAT	ADI12	Current C
AnalogValue	12	Ivag_rms	FLOAT	ADI13	Current Average
AnalogValue	13	In_rms	FLOAT	ADI14	Neutral Current
AnalogValue	14	Pa_rms	FLOAT	ADI15	Pa
AnalogValue	15	Pb_rms	FLOAT	ADI16	Pb
AnalogValue	16	Pc_rms	FLOAT	ADI17	Pc
AnalogValue	17	P_rms	FLOAT	ADI18	Total Active Power
AnalogValue	18	Qa_rms	FLOAT	ADI19	Qa
AnalogValue	19	Qb_rms	FLOAT	ADI20	Qb
AnalogValue	20	Qc_rms	FLOAT	ADI21	Qc
AnalogValue	21	Q_rms	FLOAT	ADI22	Total Reactive Power
AnalogValue	22	Sa_rms	FLOAT	ADI23	Sa
AnalogValue	23	Sb_rms	FLOAT	ADI24	Sb
AnalogValue	24	Sc_rms	FLOAT	ADI25	Sc
AnalogValue	25	S_rms	FLOAT	ADI26	Total Apparent Power
AnalogValue	26	PFa_rms	FLOAT	ADI27	PFa
AnalogValue	27	PFb_rms	FLOAT	ADI28	PFb
AnalogValue	28	PFc_rms	FLOAT	ADI29	PFc
AnalogValue	29	PF_rms	FLOAT	ADI30	Total Power Factor
AnalogValue	30	Unbl_u2	FLOAT	ADI31	Voltage Imbalance
AnalogValue	31	Unbl_i2	FLOAT	ADI32	Current Imbalance
AnalogValue	32	Rlc_val	FLOAT	ADI33	Load Characteristics
AnalogValue	33	P_dema	FLOAT	ADI34	P Demand
AnalogValue	34	Q_dema	FLOAT	ADI35	Q Demand
AnalogValue	35	S_dema	FLOAT	ADI36	S Demand
AnalogValue	36	Ia_Demand	FLOAT	ADI37	Ia Demand
AnalogValue	37	Ib_Demand	FLOAT	ADI38	Ib Demand
AnalogValue	38	Ic_Demand	FLOAT	ADI39	Ic Demand

ObjectType	Instance	Name	Object DataType	Value	Descriptor
AnalogValue	39	Active_Energy_IMP	UINT32	ADI40	Active_Energy_IMP
AnalogValue	40	Active_Energy_EXP	UINT32	ADI41	Active_Energy_EXP
AnalogValue	41	Reactive_Energy_IMP	UINT32	ADI42	Reactive_Energy_IMP
AnalogValue	42	Reactive_Energy_EXP	UINT32	ADI43	Reactive_Energy_EXP
AnalogValue	43	Active_Energy_TOTAL	UINT32	ADI44	Active_Energy_TOTAL
AnalogValue	44	Active_Energy_NET	SINT32	ADI45	Active_Energy_NET
AnalogValue	45	Reactive_Energy_TOTAL	UINT32	ADI46	Reactive_EnergyTOTAL
AnalogValue	46	Reactive_Energy_NET	SINT32	ADI47	Reactive_Energy_NET
AnalogValue	47	Apprent_Energy	UINT32	ADI48	Apprent_Energy
AnalogValue	48	THD_V1	UINT16	ADI49	THD_V1
AnalogValue	49	THD_V2	UINT16	ADI50	THD_V2
AnalogValue	50	THD_V3	UINT16	ADI51	THD_V3
AnalogValue	51	THD_V	UINT16	ADI52	THD_V
AnalogValue	52	THD_I1	UINT16	ADI53	THD_I1
AnalogValue	53	THD_I2	UINT16	ADI54	THD_I2
AnalogValue	54	THD_I3	UINT16	ADI55	THD_I3
AnalogValue	55	THD_I	UINT16	ADI56	THD_I

5.5.7 Browse the web server

- 1) Configure your Power Meter, make sure your module connected to your computer or access LAN.
- 2) Consult your module IP through the meter front panel.
- 3) Open your web browser and connect to the meter at the address you found on the Meter.
- 4) Then you will come to the main page.

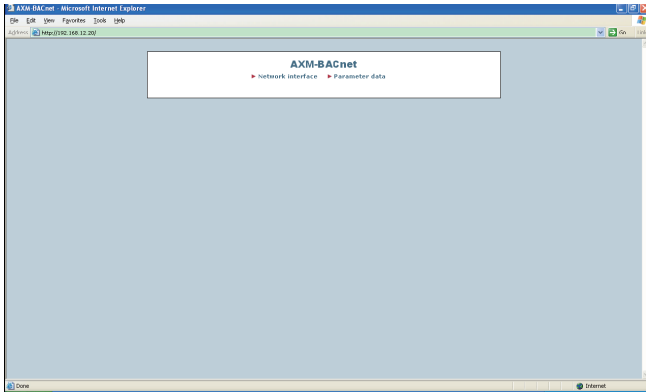

Fig 5-86

5) Click the Network interface, you will see network information.

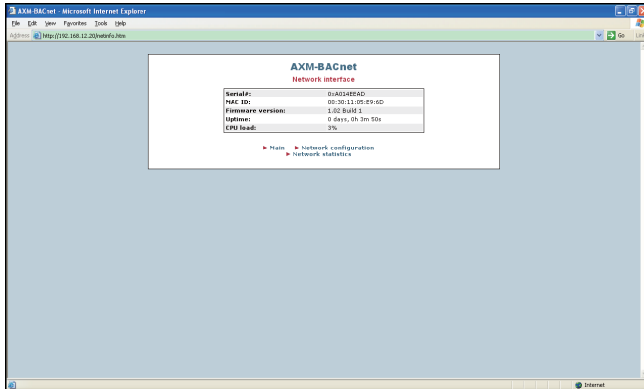

Fig 5-87

6) Click the Network configuration, you will see network configure page, it is something about the IP setting parameter.

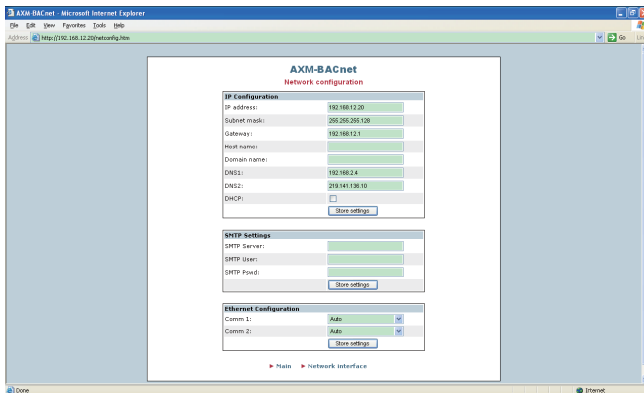

Fig 5-88

7) Click the Network statistics, you will see network status page, it is something about the module network parameter status.

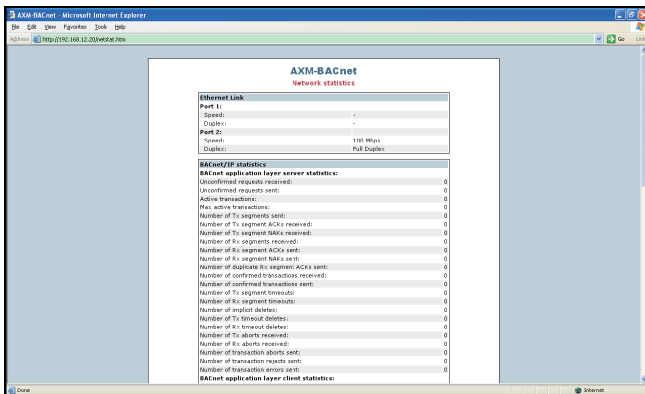

Fig 5-89

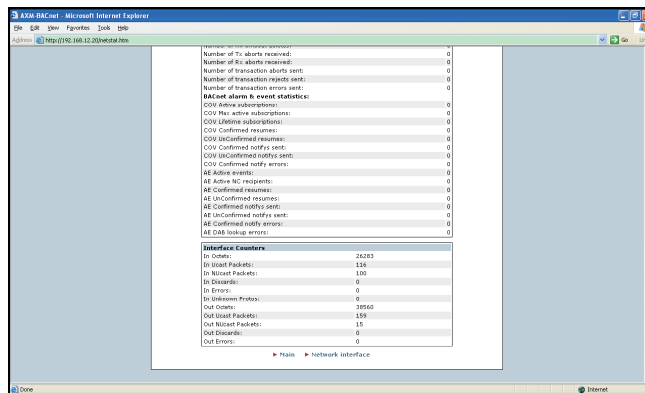

Fig 5-90

8) At the main page. Click the Parameter data, you will see all the parameter data, it is real time parameter data for communication.

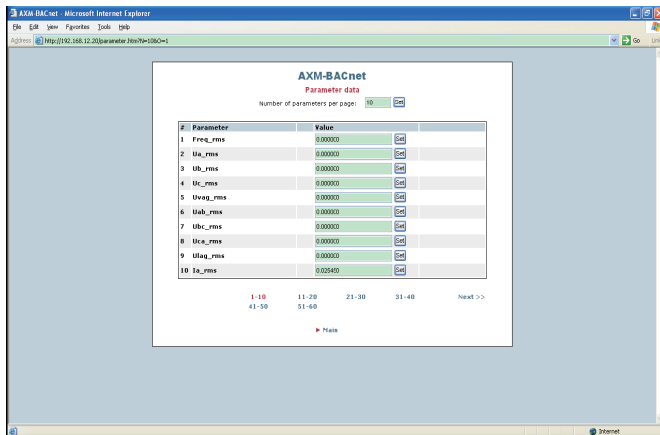

Fig 5-91

Chapter 6 Communication

6.1 Modbus Protocol Introduction

6.2 Communication Format

6.3 Data Address Table and Application Details

6.3.1 System Parameter Setting

6.3.2 System Status Parameter

6.3.3 Date and Time Table

6.3.4 Over/Under Limit Alarming Setting

6.3.5 I/O Modules Settings

6.3.6 100ms Refresh Metering Parameter

6.3.7 Metering Parameter Address Table

6.3.8 Data Logging

6.3.9 Time of use

6.4 DNP3.0 Protocol Introduction

This chapter will mainly discuss how to handle the meter via the communication port using software. It is highly recommended that previous chapters be read before moving onto Chapter 5, a familiarity with Modbus would also be helpful.

6.1 Modbus Protocol Introduction

Modbus™ RTU protocol is used for communication in Acuvim II series meters. Data format and error check methods are defined in Modbus protocol. The half duplex query and respond mode is adopted in Modbus protocol. There is only one master device in the communication network. The others are slave devices, waiting for the query of the master.

Transmission mode

The mode of transmission defines the data structure within a frame and the rules used to transmit data. The mode is defined in the following which is compatible with Modbus RTU Mode*.

Framing

Table 6-1 Data Frame Format

Address	Function	Data	Check
8-Bits	8-Bits	Nx8-Bits	16-Bits

Coding System	8-bit binary
Start bit	1
Data bits	8
Parity	no parity, odd parity, even parity
Stop bit	1 or 2
Error checking	CRC check

Address Field

The address field of a message frame contains eight bits. Valid slave device

addresses are in the range of 0~247 decimal. A master addresses a slave by placing the slave address in the address field of the message. When the slave sends its response, it places its own address in this address field of the response to let the master know which slave is responding.

Function Field

The function code field of a message frame contains eight bits. Valid codes are in the range of 1~255 decimal. When a message is sent from a master to a slave device the function code field tells the slave what kind of action to perform.

Table 6-2 Function Code

Code	Meaning	Action
01	Read Relay Output Status	Obtain current status of Relay Output
02	Read Digital Input(DI) Status	Obtain current status of Digital Input
03	Read Data	Obtain current binary value from one or more registers
05	Control Relay Output	Force relay state to "ON" or "OFF"
16	Press Multiple-Register	Place specific binary values into a series of consecutive Multiple-Registers

Data Field

The data field is constructed using sets of two hexadecimal digits, in the range of 00 to FF hexadecimal. The data field of messages sent from a master to slave devices contains additional information which the slave must use to take the action defined by the function code. This can include items such as register addresses, the quantity of items to be handled, and the count of actual data bytes in the field. For example, if the master requests a slave to read a group of holding registers (function code 03), the data field specifies the starting register and how many registers are to be read. If the master writes to a group of registers in the slave (function code 10 hexadecimal), the data field specifies the starting register, how many registers to write, the count of data bytes to follow

in the data field, and the data to be written into the registers.

If no error occurs, the data field of a response from a slave to a master contains the data requested. If an error occurs, the field contains an exception code that the master application can use to determine the next action to be taken. The data field can be nonexistent (of zero length) in certain kinds of messages.

Error Check Field

Every message includes an error checking field which is based on the Cyclical Redundancy Check (CRC) method. The CRC field checks the contents of the entire message. It is applied regardless of any parity check method used for the individual characters of the message. The CRC field is two bytes long, containing a 16-bit binary value. The CRC value is calculated by the transmitting device, and is appended to the message.

The receiving device recalculates the CRC value during reception of the message, and compares the calculated value to the actual value it received in the CRC field. If the two values are not equal, an error will be reported. CRC calculation is first started by preloading the whole 16-bit register to 1's. The process begins by applying successive 8-bit bytes of the message to the current contents of the register. Only the eight bits of data in each character are used for generating the CRC. Start and stop bits, and the parity bit, do not apply to the CRC. When generating the CRC, each 8-bit character is exclusive ORed with the register contents. The result is shifted towards the least significant bit (LSB), with a zero filled into the most significant bit (MSB) position. The LSB is extracted and examined, if the LSB equals to 1, the register is exclusive ORed with a preset, fixed value; if the LSB equals to 0, no action will be taken. This process is repeated until eight shifts have been performed. After the last (eighth) shift, the next 8-bit byte is exclusive ORed with the register's current value, and the process repeats for eight more shifts as described above. After all the

bytes of the message have been applied, the final contents of the register, which should exchange the high-byte and the low-byte, is the CRC value. When the CRC is appended to the message, the low-order byte is appended first, followed by the high-order byte.

6.2 Communication Format

Explanation of frame

Table 6-3 Explanation of frame

Addr	Fun	Data start reg HI	Data start reg LO	Data #of regs HI	Data #of regs LO	CRC 16 HI	CRC 16 LO
06H	03H	00H	00H	00H	21H	84H	65H

The meaning of each abbreviated word is:

Addr: Address of slave device

Fun: Function code

Data start reg HI: Start register address high byte

Data start reg LO: Start register address low byte

Data #of reg HI: Number of register high byte

Data #of reg LO: Number of register low byte

CRC16 HI: CRC high byte

CRC16 LO: CRC low byte

1. Reading Relay Status

Function Code 01

This function code is used to read the status of the relay in the meter.

1=On 0=Off

Relay1's address is 0000H, Relay2's address is 0001H, and so on.

The following query is to read the relay status for the meter with communication address 17.

Query

Table 6-4 Read the status of Relay1 and Relay2 Query Message

Addr	Fun	Relay start reg HI	Relay start reg LO	Relay #of regs HI	Relay #of regs LO	CRC 16 HI	CRC 16 LO
11H	01H	00H	00H	00H	02H	BFH	5BH

Response

The Acuvim II series meter response includes the meter address, function code, quantity of data byte, the data, and error checking. An example response to read the status of Relay1 and Relay2 is shown as Table 5-5. The status of Relay1 and Relay2 are responding to the last 2 bits of the data.

Relay1: bit0 Relay2: bit1

Table 6-5 Relay status response

Address	Function code	Byte count	Data	CRC high	CRC low
11H	01H	01H	02H	D4H	89H

The content of the data is:

7	6	5	4	3	2	1	0
0	0	0	0	0	0	1	0

MSB

LSB

Relay1 = OFF (LSB), Relay2=ON (Left to LSB)

2. Read Status of DI

Function Code 02

1=On 0=Off

DI1's address is 0000H, DI2's address is 0001H, and so on.

The following query is to read the Status of 4 DIs of Acuvim II series meter with communication address 17.

Query

Table 6-6 Read 4 DIs Query Message

Addr	Fun	DI start addr HI	DI start addr LO	DI num HI	DI num LO	CRC 16 HI	CRC 16 LO
11H	02H	00H	00H	00H	04H	7BH	59H

Response

The AcuVim II series meter response includes the meter address, function code, quantity of data characters, the actual data characters and error checking. An example response to read the status of 4 DIs are shown in Table 5-7. The DI status corresponds to the last 4 bits of the data.

DI1: bit0; DI2: bit1; DI3: bit2; DI4: bit3.

Table 6-7 Read Status of DI

Address	Function code	Byte count	Data	CRC high	CRC low
11H	02H	01H	03H	E5H	49H

The content of the data is:

7	6	5	4	3	2	1	0
0	0	0	0	0	0	1	1

MSB

LSB

DI1=On, DI2=On, DI3=Off, DI4=Off.

3. Read Data (Function Code 03)

Query

This function allows the master to obtain the measurement results from the AcuVim II series meter. Table 6-8 is an example of reading the measured data (F, V1 and V2) from slave device number 17, the data address of F is 4000H, 4001H; V1's address is 4002H, 4003, and V2's address is 4004H, 4005H.

Table 6-8 Read F, V1, V2 Query Message

Addr	Fun	Data start addr HI	Data start addr LO	Data #of regs HI	Data #of regs LO	CRC 16 regs HI	CRC 16 regs LO
11H	03H	40H	00H	00H	06H	D2H	98H

Response

The Acuvim II series meter response includes the meter address, function code, quantity of data bytes, data, and error checking. An example response to read F, V1 and V2 (F=42480000H (50.00Hz), V1=42C7CCCDH (99.9V), V2=42C83333H (100.1V)) is shown:

Table 6-9 Read F, V1 and V2 Message

Addr	Fun	Byte count	Data1 HI	Data1 LO	Data 2 HI	Data2 LO	Data3 HI	Data3 LO	Data4 HI	Data4 LO
11H	3H	0CH	42H	48H	00H	00H	42H	C7H	CCH	CDH
Data5 HI	Data5 LO	Data 6 HI	Data6 LO	CRC16 HI	CRC16 LO					
42H	C8H	33H	33H	CAH	7FH					

4. Control Relay (Function Code 05)

Query

This message forces a relay to either turn "ON" or "OFF". Any relay that exists within the Acuvim II series meter can be forced to either "ON" or "OFF" status. The data value FF00H will set the relay on and the value 0000H will turn it off; all other values are invalid and will not affect that relay.

The example below is a request to the Acuvim II series meter with the address of 17 to turn on Relay1.

Table 6-10 Control Relay Query Message

Addr	Fun	DO addr HI	DO addr LO	Value HI	Value LO	CRC 16 HI	CRC 16 LO
11H	05H	00H	00H	FFH	00H	8EH	AAH

Response

The normal response to the command request is to retransmit the message as received after the relay status has been altered.

Table 6-11 Control Relay Response Message

Addr	Fun	Relay addr HI	Relay addr LO	Value HI	Value LO	CRC HI	CRC LO
11H	05H	00H	00H	FFH	00H	8EH	AAH

5. Preset / Reset Multi-Register (Function Code 16)

Query

Function 16 allows the user to modify the contents of a multi-register. Some registers of Acuvim II series meter can have their contents changed by this message. The example below is a request to an Acuvim II series meter with the address of 17 to preset Ep_imp as "17807783.3KWh", while its HEX value is 0A9D4089H. Ep_imp data address is 4048H and 4049H.

Table 6-12 Preset Multi-Register Query Message

Addr	Fun	Data start reg HI	Data start reg LO	Data #of reg HI	Data #of reg LO	Byte Count
11H	10H	40H	48H	00H	02H	04H
Value HI	Value LO	Value HI	Value LO	CRC HI	CRC LO	
0AH	9DH	40H	89H	F1H	6AH	

Response

The normal response to a preset multi-register request includes the Acuvim II series meter address, function code, data start register, the number of registers, and error checking.

Table 6-13 Preset Multi-Register Response Message

Addr	Fun	Data start reg hi	Data start reg lo	Data #of reg hi	Data #of Reg lo	CRC16 hi	CRC16 lo
11H	10H	40H	48H	00H	02H	D6H	8EH

6.3 Data Address Table and Application Details

There are several rules to follow in using the meter:

1. Data type:

“bit” refers to binary.

“word” refers to 16-bit unsigned integer using one data address and 2 bytes of memory, it varies from 0 to 65535.

“int” refers to 16-bit integer using one data address and 2 bytes of memory, it varies from -32768 to 32767.

“dword” refers to 32-bit unsigned integer using two data addresses and 4 bytes of memory with high word at the front and low word at the end, it varies from 0 to 4294967295. Rx=high word *65536+low word.

“float” refers to 32-bit single value using two data addresses and 4 bytes of memory, it varies from -1.175494E-38 to 3.402823E+38.

2. Relationship between communication value and numerical value.

It is important to note, the numerical value may not be the same as the communication value. The following table shows how they respond to each other.

Note: In current channel, CT are optional, which include voltage type CT or current type CT.

- 1) When current type CT is selected and the value of CT2 is 1 or 5, and using relationship listed below to count primary value, the value of CT2 should be original 1 or 5.
- 2) When voltage type CT is selected and the value of CT2 is 333, and using

relationship listed below to count primary value, the value of CT2 should not be 333, but 1.

3)When you select 100mv/50Hz,or 120mv/60Hz Rope-CT,the value of CT2 is 100,and using relationship listed below to count primary value,the value of CT2 should not be 100,but 1;

4)When you select 80/100/200 mA CT,the value of CT2 is 80, 100 or 200, and using relationship listed below to count primary value,the value of CT2 should not be 80, 100 or 200, but 1.

Table 6-14

Parameters	Relationship	Unit	Format code
System parameters	Numerical value equals to communication value	No unit	F1
Run time	$T=R_x/100$	Hour	F2
Clock	Numerical value equals to communication value	Unit of time	F3
Energy(primary)	$E_p=R_x/10$	kWh	F4
Reactive energy(primary)	$E_q=R_x/10$	kvarh	F5
Apparent energy(primary)	$E_s=R_x/10$	kVA	F6
Energy(secondary)	$E_p=R_x/1000$	kWh	F7
Reactive energy (secondary)	$E_q=R_x/1000$	kvarh	F8
Apparent energy (secondary)	$E_s=R_x/1000$	kVA	F9
Frequency	$F=R_x/100$	Hz	F10
Voltage	$U=R_x \times (PT1/PT2)/10$	V	F11
Current, current demand	$I=R_x \times (CT1/CT2)/1000$	A	F12
Power, demand	$P=R_x \times (PT1/PT2) \times (CT1/CT2)$	W	F13
Reactive power, demand	$Q=R_x \times (PT1/PT2) \times (CT1/CT2)$	var	F14
Apparent power, demand	$S=R_x \times (PT1/PT2) \times (CT1/CT2)$	VA	F15
Power factor	$PF=R_x/1000$	No unit	F16
Unbalance factor	$Unbl=(R_x/1000) \times 100\%$	No unit	F17
THD	$THD=(R_x/10000) \times 100\%$	No unit	F18
Harmonics	$HDn=(R_x/10000) \times 100\%$	No unit	F19

Parameters	Relationship	Unit	Format code
Total odd HD	$HDo=(Rx/10000) \times 100\%$	No unit	F20
Total even HD	$HDe=(Rx/10000) \times 100\%$	No unit	F21
Crest factor	$CF=Rx/1000$	No unit	F22
K factor	$KF=Rx/10$	No unit	F23
THFF	$THFF=(Rx/10000) \times 100\%$	No unit	F24
Phase angle	$Phase\ angle=Rx/10$	Degree	F25

Important Note: Regions from “System parameters settings” to “Data logging 3 settings” are the regions that can be set and modified. Please follow these guidelines when communicating with the meter.

- When function code 10H is used, one communication command can only modify contents in one region, such as “System parameters settings”, “System status parameter”, “Date and Time table”, “Over/under limit alarming-Global settings”, “Over/under limit alarming-Single settings”, “I/O Modules settings”, Data logging 1 settings, Data logging 2 settings, Data logging 3 settings. It can not be accomplished in one communication order to modify contents in both of two or more regions above.
- When function code 03H is used, the rules and limitations described above will not be applied.

6.3.1 System Parameter Setting

System parameters determine how the meter works. Please refer to Chapter 3 and Chapter 4 for more details.

Function code: 03H for reading, 10H for writing. Data type: word. Format code: F1.

Table 6-15

Address	Parameter	Default	Range	Data type	Property
0FFDH	Frequency	0	0 : 50Hz 1 : 60Hz 2: 400Hz	Word	R/W
0FFEh	First communication Protocol	0	0:MODBUS Protocol 1:DNP3.0 Protocol	Word	R/W
0FFFh	Parity Setting1	3	0: EVEN 1: odd 2:NON2 3:NON1	word	R/W
1000H	Password	0	0~9999	word	R/W
1001H	Communication address	1	1~247(MODBUS) 0~65534(DNP3.0)	word	R/W
1002H	Baud rate	19200	1200~38400	word	R/W
1003H	Voltage input wiring type	0	0:3LN,1:2LN,2:2LL,3:3LL 4:1LL	word	R/W
1004H	Current input wiring type	0	0:3CT,1:1CT,2:2CT	word	R/W
1005H	PT1 (High 16 bit)	0		word	R/W
1006H	PT1 (Low 16 bit)	220.0	50.0~500000.0	word	R/W
1007H	PT2	220.0	50.0~400.0	word	R/W
1008H	CT1	5	1~50000	word	R/W
1009H	CT2	5	1,5,333,80,100,200	word	R/W
100AH	kWh pulse constant	1	1~60000(Setting method,see Remarks)	word	R/W
100BH	kvarh pulse constant	1	1~60000(Setting method,see Remarks)	word	R/W
100CH	LCD backlight time	1	0~120	word	R/W
100DH	Demand slid window time	15	1~30	word	R/W
100EH	Demand calculating mode	1	1:sliding window 2:thermal	word	R/W
100FH	Clear demand memory	0	Only 1 works	word	R/W
1010H	Max/Min clear	55H	Only 0AH works	word	R/W
1011H	Run time clear	0	Only 1 works	word	R/W

Address	Parameter	Default	Range	Data type	Property
1012H	Current I1 direction	0	0: Positive 1: Negative	word	R/W
1013H	Current I2 direction	0	0: Positive 1: Negative	word	R/W
1014H	Current I3 direction	0	0: Positive 1: Negative	word	R/W
1015H	VAR/PF convention	0	0: IEC, 1: IEEE	word	R/W
1016H	Energy clear	0	Only 1 works	word	R/W
1017H	Energy calculating mode	1	0: fundamental 1: full-wave	word	R/W
1018H	Reactive power measuring mode	0	0: real, 1: general	word	R/W
1019H	Energy display mode	0	0: primary, 1: secondary	word	R/W
101AH	Ethernet module reset	0	0: none, 1: reset, 2: load default and reset	word	R/W
101BH	SOE enable	0	0: none; 1: AXM-IO11; 2: AXM-IO21; 3: AXM-IO31; 4: AXM-IO12; 5: AXM-IO22; 6: AXM-IO32;	word	R/W
101CH	Pulse counter clear	0	0:none; 1:AXM-IO11; 2:AXM-IO21; 3:AXM-IO31; 4:AXM-IO12; 5:AXM-IO22; 6:AXM-IO32;	word	R/W
101DH	Basic parameter mode	0	0:secondary; 1:primary	word	R/W

Note:1) when OFFEH is 0, first communication protocol is set to MODBUS, while OFFEH is 1, first communication protocol is DNP3.0. At this time, special DNP3.0 software is needed, and normal software will be invalid.

2)100AH, 100BH setting method: $1000 * 3600 / (U * I * n * \text{pulse constant}) = \text{pulse period (S)}$, pulse period calculated by the pulse constant must be greater than the pulse width (20ms ~ 1000ms) of IO module DO setting, Wherein n is applied

with the user, and if the three-phase signals are added, then n is 3. U and I generally equal to user settings PT2, CT2, ie, rated voltage and rated current .

3)0x1017H: When selecting 400Hz type,only support full-wave.

6.3.2 System Status Parameters

“System status” indicates what events happened in the meter, what kinds of flags are read by user and the index of the storage of events. Flags should be cleared after being read by the controller, otherwise new data will not be stored properly.

Function code: 03H for reading, 10H for writing. Data type: word.

Table 6-16

Address	Parameter	Format code	Range	Data type	Property
101EH	Sealed Nonstandard Parameters		Bit0: 1st communication parameters Bit1: 2nd communication parameters Bit2: run time clear Bit3: DI pulse count Bit4: TOU 1: valid of corresponding selection 0: invalid	word	R/W
101FH	Seal status		0x0A: Seal sealed; Other: Seal opened.	word	R/W
1020H	Reserved				
1021H	Alarm record clear		0x0A: clear Other: not clear	word	R/W
1022H~102DH	Reserved				
102EH	System status		Bit0:new alarming or not Bit1: new SOE or not	word	R
102FH	Baud rate2	38400	4800~38400	word	R/W

Address	Parameter	Format code	Range	Data type	Property
1030H	Parity Setting2		0: EVEN 1: odd 2:NON2 3:NON1	word	R/W
1031H	Communication address2		1~247	word	R
1032H	Alarming group number	F1	0: no alarming record 1~16: last alarming record group number	word	R
1033H	SOE group number	F1	0: no SOE record 1~20: last SOE group number	word	R
1034H	Run time (high)	F2	0~999999999	word	R
1035H	Run time (low)			word	R
1036H	Expanded IO Modules connecting status		Bit0: AXM-IO11; Bit1: AXM-IO12; Bit2: AXM-IO21; Bit3: AXM-IO22; Bit4: AXM-IO31; Bit5: AXM-IO32; 0: disconnected 1: connected	word	R
1037H	Reserved				
1038H	2 nd communication selection		2: Mesh 1: BACnet Protocol 0: Other Protocol	word	R/W
1039H	Ten years download setting enable		1: enable is valid	word	R/W
103AH	Fee of sharp demand clear		0x0A: clear Other: not clear	word	R/W
103BH	Fee of peak demand clear		0x0A: clear Other: not clear	word	R/W
103CH	Fee of valley demand clear		0x0A: clear Other: not clear	word	R/W
103DH	Fee of normal demand clear		0x0A: clear Other: not clear	word	R/W
103EH	Total fee of demand clear		0x0A: clear Other: not clear	word	R/W

Note:

- 1) Please refer to Chapter 3 and Chapter 4 for more details about parameter settings.
- 2) When 1038H is 2, second communication is set to MESH, you should set 9600bps and NON1 for the second communication. When 1038H is 1, second communication protocol is set to BACnet protocol, while second communication should select BACnet module. When 1038H is 0, second communication protocol is set to other protocols, while second communication should select second RS-485 module, PROFIBUS module or Ethernet module. If selected protocol doesn't match attached module, communication can not process. If you use Ethernet or PROFIBUS module, you should set 38400 bps and NON1 for the second communication. When Ethernet or Profibus module will connect normally, user can't change the protocol, baud and parity.

6.3.3 Date and Time Table

Function code: 03H for reading, 10H for presetting.

Table 6-17

Address	Parameter	Format code	Range	Data type	Property
103FH	week	F3	0~6	word	R/W
1040H	Year	F3	2000-2099	word	R/W
1041H	Month	F3	1~12	word	R/W
1042H	Day	F3	1~31	word	R/W
1043H	Hour	F3	0~23	word	R/W
1044H	minute	F3	0~59	word	R/W
1045H	second	F3	0~59	word	R/W

6.3.4 Over/Under Limit Alarming Setting

This setting consists of global alarm settings and single channel alarm settings. Global alarm settings contain settings of all global variables. There are 16 groups of records with the same format. Function code: 03H for reading, 10H for writing. Please refer to Chapter 4 for more details.

Global alarming settings

Table 6-18

Address	Parameter	Range	Data type	Property
1046H	Global alarming enable	0:disable;1:enable	word	R/W
1047H	Alarming flash enable	0:disable;1:enable	word	R/W
1048H	Alarming channel enable setting	0~65535 Bit0:channel 1 1:enable; 0:disable Bit1: channel 2 Bit15: channel 16	word	R/W
1049H	Logic "And " between alarming setting	0~255 Bit0: first logic switch 1:enable;0:disable Bit1: second logic switch Bit7: eighth logic switch	word	R/W
104AH	Alarming output to DO1 setting	0~65535 Bit0: channel 1 output 1:enable;0:disable Bit1: channel 2 output Bit15: channel 16 output	word	R/W
104BH	Alarming output to DO2 setting	0~65535 The same as previous	word	R/W
104CH	Alarming output to DO3 setting	0~65535 The same as previous	word	R/W
104DH	Alarming output to DO4 setting	0~65535 The same as previous	word	R/W

Single channel alarming settings

Table 6-19

Address	Parameter	Format code	Range	Data type	Property
104EH	First group: parameter code	F1	0~79	word	R/W

Address	Parameter	Format code	Range	Data type	Property
104FH	First group: comparison mode	F1	1: greater than; 2: equal to; 3: less than	word	R/W
1050H	First group: setpoint value	F10~F18	Related with parameters	word	R/W
1051H	First group: delay	F1	0~3000(*10ms)	word	R/W
1052H	First group: output to relay	F1	0:none, 1~8: related relay	word	R/W
1053H~109DH	2 nd to 16 th group		Same as the first group	word	R/W

Alarming parameter code table

Table 6-20

Setting value	Alarming object	Setting value	Alarming object	Setting value	Alarming object
0	Frequency	1	Va	2	Vb
3	Vc	4	Average phase voltage	5	Uab
6	Ubc	7	Uca	8	Average line voltage
9	current of phase A	10	current of phase B	11	current of phase C
12	Average current	13	Neutral current	14	Power of phase A
15	Power of phase B	16	Power of phase C	17	Power of all
18	Reactive power of phase A	19	Reactive power of phase B	20	Reactive power of phase C
21	Reactive power of all	22	Apparent power of phase A	23	Apparent power of phase B
24	Apparent power of phase C	25	Apparent power of all	26	PF of A
27	PF of B	28	PF of C	29	PF
30	Voltage unbalance factor U_unbl	31	Current unbalance factor I_unbl	32	Load characteristic(R/L/C)

Setting value	Alarming object	Setting value	Alarming object	Setting value	Alarming object
33	THD_V1(V1 or V12)	34	THD_V2(V2 or V31)	35	THD_V3(V3 or V23)
36	Average THD_V	37	THD_I1	38	THD_I2
39	THD_I3	40	Average THD_I	41	AI1 sampling value
42	AI2 sampling value	43	AI3 sampling value	44	AI4 sampling value
45	Active power demand of all	46	Reactive power demand of all	47	Apparent power demand of all
48	Current demand of phase A	49	Current demand of phase B	50	Current demand of phase C
51	reversed phase sequence	52~79	DI1~DI28		

Note:

1. When reversed phase sequence (51) is selected, whether the value of comparison mode or setpoint value is set or not doesn't affect alarm result and angle of U_b to U_a will be recorded.
2. When DI (52~79) is selected, whether the value of comparison mode is set or not doesn't affect alarm result and as long as setpoint value is set to 1, 2 or 3.
 - 1 stands for DI alarm is from OFF to ON, and recovery is from ON to OFF.
 - 2 stands for DI alarm is from ON to OFF, and recovery is from OFF to ON.
 - 3 stands for DI alarm from ON to OFF, and recovery is from OFF to ON, and present DI status is recorded.

6.3.5 I/O Modules Settings

I/O module setting changes will be made only if the corresponding I/O modules are installed, no changes will be made otherwise. Please check the I/O module connection status before doing any settings. Function code: 03H for reading, 10H for writing. Please refer to Chapter 5 Extended Modules for more details.

AXM-IO11

Table 6-21

Address	Parameter	Default	Range	Data type	Property
109EH	DI1~6 type	0	Bit0: DI1, Bit1: DI2 Bit2: DI3, Bit3: DI4 Bit4: DI5, Bit5: DI6 0: DI, 1: pulse counter	word	R/W
109FH	DI pulse constant	0	1~65535	word	R/W
10A0H	Working mode of relay 1 and 2	0	0: control output, 1: alarming output	word	R/W
10A1H	Output mode of relay 1 and 2	0	0: latch, 1: pulse	word	R/W
10A2H	Pulse width	50	50~3000ms	word	R/W

AXM-IO21

Table 6-22

Address	Parameter	Default	Range	Data type	Property
10A3H	DI7~10 type	0	Bit0: DI7, Bit1: DI8 Bit2: DI9, Bit3: DI10 0: DI, 1: pulse counter	word	R/W
10A4H	DI pulse constant	0	1~65535	word	R/W
10A5H	Working mode of DO	0	0: pulse output 1: alarming output	word	R/W
10A6H	DO pulse width	20	20~1000ms	word	R/W
10A7H	DO1 output	0	0: none 1: consumption power 2: generating power 3: absorption reactive power 4: generating reactive power	word	R/W
10A8H	DO2 output	0	Same as above	word	R/W
10A9H	AO1,2 type	1 or 2	0: 0~20mA, 1: 4~20mA, 2: 0~5V, 3: 1~5V	word	R/W

AXM-IO31

Table 6-23

Address	Parameter	Default	Range	Data type	Property
10AAH	DI11~14 type	0	Bit0: DI11, Bit1: DI12, Bit2: DI13, Bit3: DI14 0: DI, 1: pulse counter	word	R/W
10ABH	DI pulse constant	0	1~65535	word	R/W
10ACH	Working mode of relay 3 and 4	0	0: control output, 1: alarming output	word	R/W
10ADH	Output mode of relay 3 and 4	0	0: latch, 1: pulse	word	R/W
10AEH	Pulse width	50	50~3000ms	word	R/W
10AFH	AI1,2 type	1 or 2	0: 0~20mA, 1: 4~20mA, 2: 0~5V, 3: 1~5V	word	R/W

AXM-IO12

Table 6-24

Address	Parameter	Default	Range	Data type	Property
10B0H	DI15~20 type	0	Bit0: DI15, Bit1: DI16, Bit2: DI17, Bit3: DI18, Bit4: DI19, Bit5: DI20 0-DI, 1-pulse counter	word	R/W
10B1H	DI pulse constant (high)	0	1~65535	word	R/W
10B2H	Working mode of relay 5 and 6	0	0: control output, 1: alarming output	word	R/W
10B3H	Output mode of relay 5 and 6	0	0: latch, 1: pulse	word	R/W
10B4H	Pulse width	50	50-3000ms	word	R/W

AXM-IO22

Table 6-25

Address	Parameter	Default	Range	Data type	Property
10B5H	DI21~24 type	0	Bit0: DI21, Bit1: DI22, Bit2: DI23, Bit3: DI24 0: DI, 1: pulse counter	word	R/W
10B6H	DI pulse constant	0	1~65535	word	R/W
10B7H	Working mode of DO3,4	0	0: pulse output, 1: alarming output	word	R/W
10B8H	DO Pulse width	20	20~1000ms	word	R/W
10B9H	DO3 output	0	0: none 1: consumption power 2: generating power 3: absorption reactive power 4: generating reactive power	word	R/W
10BAH	DO4 output	0	Same as above	word	R/W
10BBH	AO3,4 type	1 or 2	0: 0~20mA, 1: 4~20mA, 2: 0~5V, 3: 1~5V	word	R/W

AXM-IO32

Table 6-26

Address	Parameter	Default	Range	Data type	Property
10BCH	DI25~28 type	0	Bit0: DI25, Bit1: DI26, Bit2: DI27, Bit3: DI28 0: DI, 1: pulse counter	word	R/W
10BDH	DI pulse constant	0	1~65535	word	R/W
10BEH	Working mode of relay 7 and 8	0	0: control output, 1: alarming output	word	R/W
10BFH	Output mode of relay 7 and 8	0	0: latch, 1: pulse	word	R/W
10C0H	Pulse width	50	50~3000	word	R/W
10C1H	AI3,4 type	1 or 2	0: 0~20mA, 1: 4~20mA, 2: 0~5V, 3: 1~5V	word	R/W

AO transforming select

Table 6-27

Address	Parameter	Default	Range	Data type	Property
10C2H	AO1 transforming parameter	0	Refer to following table	word	R/W
10C3H	AO2 transforming parameter	0	Refer to following table	word	R/W
10C4H	AO3 transforming parameter	0	Refer to following table	word	R/W
10C5H	AO4 transforming parameter	0	Refer to following table	word	R/W

AO transforming parameter settings

Table 6-28

Setting value	Transforming object	Setting value	Transforming object	Setting value	Transforming object
0	Frequency	1	Va	2	Vb
3	Vc	4	Average phase voltage	5	Uab
6	Ubc	7	Uca	8	Average line voltage
9	current of phase A	10	current of phase B	11	current of phase C
12	Average current	13	Neutral current	14	Power of phase A
15	Power of phase B	16	Power of phase C	17	Power of all
18	Reactive power of phase A	19	Reactive power of phase B	20	Reactive power of phase C
21	Reactive power of all	22	Apparent power of phase A	23	Apparent power of phase B
24	Apparent power of phase C	25	Apparent power of all	26	PF of A
27	PF of B	28	PF of C	29	PF

Table 6-29

Address	Parameter	Default	Range	Data type	Property
10D0H	AO1 Gradient Number Selection of input/output transfer curve	1	1: 1 Gradient 2: 2 Gradient 3: 3 Gradient	INT	R/W
10D1H	AO1 following value range setting start point		Please see Note	INT	R/W
10D2H	AO1 following value range setting point 2			INT	R/W
10D3H	AO1 following value range setting point 3			INT	R/W
10D4H	AO1 following value range setting end point			INT	R/W
10D5H	AO1 output range setting start point		AO type of 0~24A or 0~6: 0~4915 AO type of 4~24A or 1~6: 819~4915	INT	R/W
10D6H	AO1 output range setting point 2			INT	R/W
10D7H	AO1 output range setting point 3			INT	R/W
10D8H	AO1 output range setting end point			INT	R/W
10D9-10E1H	AO2 Gradient Setting(same as AO1)		same as AO1	INT	R/W
10E2H-10EAH	AO3 Gradient Setting(same as AO1)		same as AO1	INT	R/W
10EBH-10F3H	AO4 Gradient Setting(same as AO1)		same as AO1	INT	R/W

Note:

- 1) AO Gradient Number Selection of input/output transfer curve

When number is 1, only AO following value range setting start point, AO following value range setting end point, AO1 output range setting start point and AO1 output range setting end point should be set.

When number is 2, only AO following value range setting start point, AO1 following value range setting point 2, AO following value range setting end point, AO1 output range setting start point , AO1 output range setting point 2 and AO1 output range setting end point should be set.

When number is 3, only AO following value range setting start point, AO1 following value range setting point 2, AO1 following value range setting point 3 and AO following value range setting end point should be set. At the same time, AO1 output range setting start point, AO1 output range setting point 2, AO1 output range setting point 3 and AO1 output range setting end point should be set.

2) following value range setting:

AO following value range setting start point, AO1 following value range setting point 2, AO1 following value range setting point 3 and AO following value range setting end point are increasing value, while they should be within range of AO following value. Otherwise, the function of AO will be affected.

Frequency: When selecting 50Hz or 60Hz type, frequency range is 45Hz ~ 65Hz, real setting value is 4500 ~ 6500;

When selecting 400Hz type, frequency range is 300Hz ~ 500Hz, real setting value is 30000~50000,;

Phase voltage V1, V2, V3 and average phase voltage: 0~480V, real setting value is 0~4800.

Line voltage V12, V23, V31 and average line voltage: 0~831V, real setting value is 0~8310.

Current I1, I2, I3 and average current: 0~10A, real setting value is 0~10000.

Power Pa, Pb and Pc: -4800~4800W, real setting value is -4800~4800

System power: -14400~14400W, real setting value is -14400~14400.

Reactive power Qa, Qb and Qc: -4800~4800 Var, real setting value is -4800~4800.

System reactive power: -14400~14400 Var.

Apparent power Sa, Sb and Sc: 0~4800VA, real setting value is 0~4800.

System apparent power: 0~14400VA, real setting value is 0~14400.

Power factor PFa, PFb, PFc and System power factor: -1~1, real setting value is -1000~1000.

3) AO output range setting:

AO output value range setting start point, AO1 output value range setting point 2, AO1 output value range setting point 3 and AO output value range setting end point are increasing value, while they should be within range of AO output value.

When AO type is 0~20mA, the setting value range is 0~ 4915, and the relationship is $\text{mA}=\text{setting value} * 20 / 4096$.

When AO type is 4~20mA, the setting value range is 819~ 4915, and the relationship is $\text{mA}=\text{setting value} * 20 / 4096$.

When AO type is 0~5V, the setting value range is 0~ 4915, and the relationship is $\text{V}=\text{setting value} * 5 / 4096$.

When AO type is 1~5V, the setting value range is 819~ 4915, and the relationship is $\text{V}=\text{setting value} * 5 / 4096$.

6.3.6 100ms Refresh Metering Parameter

Table 6-30

Address	Parameter	Code	Relationship	Data type	Property
3000H~3001H	Frequency	F1	$F = \text{Rx}$	float	R
3002H~3003H	Phase voltage V1	F1	$U = \text{Rxx}(PT1/PT2)$	float	R
3004H~3005H	Phase voltage V2	F1	$U = \text{Rxx}(PT1/PT2)$	float	R
3006H~3007H	Phase voltage V3	F1	$U = \text{Rxx}(PT1/PT2)$	float	R
3008H~3009H	Average voltage Vavg	F1	$U = \text{Rxx}(PT1/PT2)$	float	R
300AH~300BH	Line voltage V12	F1	$U = \text{Rxx}(PT1/PT2)$	float	R
300CH~300DH	Line voltage V23	F1	$U = \text{Rxx}(PT1/PT2)$	float	R
300EH~300FH	Line voltage V31	F1	$U = \text{Rxx}(PT1/PT2)$	float	R
3010H~3011H	Average line voltage Vavg	F1	$U = \text{Rxx}(PT1/PT2)$	float	R
3012H~3013H	Current I1	F1	$I = \text{Rxx}(CT1/CT2)$	float	R
3014H~3015H	Current I2	F1	$I = \text{Rxx}(CT1/CT2)$	float	R
3016H~3017H	Current I3	F1	$I = \text{Rxx}(CT1/CT2)$	float	R
3018H~3019H	Average current Iavg	F1	$I = \text{Rxx}(CT1/CT2)$	float	R
301AH~301BH	Neutral current In	F1	$I = \text{Rxx}(CT1/CT2)$	float	R
301CH~301DH	Phase A power Pa	F1	$P = \text{Rxx}(PT1/PT2) \times (CT1/CT2)$	float	R
301EH~301FH	Phase B power Pb	F1	$P = \text{Rxx}(PT1/PT2) \times (CT1/CT2)$	float	R
3020H~3021H	Phase C power Pc	F1	$P = \text{Rxx}(PT1/PT2) \times (CT1/CT2)$	float	R
3022H~3023H	System power Psum	F1	$P = \text{Rxx}(PT1/PT2) \times (CT1/CT2)$	float	R
3024H~3025H	Phase A reactive power Qa	F1	$Q = \text{Rxx}(PT1/PT2) \times (CT1/CT2)$	float	R
3026H~3027H	Phase B reactive power Qb	F1	$Q = \text{Rxx}(PT1/PT2) \times (CT1/CT2)$	float	R
3028H~3029H	Phase C reactive power Qc	F1	$Q = \text{Rxx}(PT1/PT2) \times (CT1/CT2)$	float	R
302AH~302BH	System reactive power Qsum	F1	$Q = \text{Rxx}(PT1/PT2) \times (CT1/CT2)$	float	R
302CH~302DH	Phase A apparent power Sa	F1	$S = \text{Rxx}(PT1/PT2) \times (CT1/CT2)$	float	R

Address	Parameter	Code	Relationship	Data type	Property
3302EH~302FH	Phase B apparent power S_b	F1	$S=R_x \times (PT1/PT2) \times (CT1/CT2)$	float	R
3030H~3031H	Phase C apparent power S_c	F1	$S=R_x \times (PT1/PT2) \times (CT1/CT2)$	float	R
3032H~3033H	System apparent power S_{sum}	F1	$S=R_x \times (PT1/PT2) \times (CT1/CT2)$	float	R
3034H~3035H	Phase A power factor PF_a	F1	$PF = R_x$	float	R
3036H~3037H	Phase B power factor PF_b	F1	$PF = R_x$	float	R
3038H~3039H	Phase C power factor PF_c	F1	$PF = R_x$	float	R
303AH~303BH	System power factor PF_{sum}	F1	$PF = R_x$	float	R

6.3.7 Metering Parameter Address Table

Basic Analog measurements

There are two different modes to read basic analog measurements, one is secondary mode, and another is primary mode. In primary mode, the numerical value in the register of the meter is equal to the real physical value. In secondary mode, the relationship between the numerical value in the register and the real physical value is shown in the following table. (R_x is the numerical value in register of Acuvin II series meter)

Function code: 03H for reading.

Table 6-31

Address	Parameter	Code	Relationship	Data type	Property
4000H~4001H	Frequency	F1	$F = R_x$	float	R
4002H~4003H	Phase voltage V1	F1	$U = R_{xx}(PT1/PT2)$	float	R
4004H~4005H	Phase voltage V2	F1	$U = R_{xx}(PT1/PT2)$	float	R
4006H~4007H	Phase voltage V3	F1	$U = R_{xx}(PT1/PT2)$	float	R
4008H~4009H	Average voltage Vavg	F1	$U = R_{xx}(PT1/PT2)$	float	R
400AH~400BH	Line voltage V12	F1	$U = R_{xx}(PT1/PT2)$	float	R
400CH~400DH	Line voltage V23	F1	$U = R_{xx}(PT1/PT2)$	float	R
400EH~400FH	Line voltage V31	F1	$U = R_{xx}(PT1/PT2)$	float	R
4010H~4011H	Average line voltage Vlavg	F1	$U = R_{xx}(PT1/PT2)$	float	R
4012H~4013H	current I1	F1	$I = R_{xx}(CT1/CT2)$	float	R
4014H~4015H	current I2	F1	$I = R_{xx}(CT1/CT2)$	float	R
4016H~4017H	current I3	F1	$I = R_{xx}(CT1/CT2)$	float	R
4018H~4019H	Average current Iavg	F1	$I = R_{xx}(CT1/CT2)$	float	R
401AH~401BH	Neutral current In	F1	$I = R_{xx}(CT1/CT2)$	float	R
401CH~401DH	Phase A power Pa	F1	$P = R_{xx}(PT1/PT2) \times (CT1/CT2)$	float	R
401EH~401FH	Phase B power Pb	F1	$P = R_{xx}(PT1/PT2) \times (CT1/CT2)$	float	R
4020H~4021H	Phase C power Pc	F1	$P = R_{xx}(PT1/PT2) \times (CT1/CT2)$	float	R
4022H~4023H	System power Psum	F1	$P = R_{xx}(PT1/PT2) \times (CT1/CT2)$	float	R
4024H~4025H	Phase A reactive power Qa	F1	$Q = R_{xx}(PT1/PT2) \times (CT1/CT2)$	float	R
4026H~4027H	Phase B reactive power Qb	F1	$Q = R_{xx}(PT1/PT2) \times (CT1/CT2)$	float	R
4028H~4029H	Phase C reactive power Qc	F1	$Q = R_{xx}(PT1/PT2) \times (CT1/CT2)$	float	R
402AH~402BH	System reactive power Qsum	F1	$Q = R_{xx}(PT1/PT2) \times (CT1/CT2)$	float	R
402CH~402DH	Phase A apparent power Sa	F1	$S = R_{xx}(PT1/PT2) \times (CT1/CT2)$	float	R
402EH~402FH	Phase B apparent power Sb	F1	$S = R_{xx}(PT1/PT2) \times (CT1/CT2)$	float	R

Address	Parameter	Code	Relationship	Data type	Property
4030H~4031H	Phase C apparent power Sc	F1	$S=R_{xx}(PT1/PT2) \times (CT1/CT2)$	float	R
4032H~4033H	System apparent power Ssum	F1	$S=R_{xx}(PT1/PT2) \times (CT1/CT2)$	float	R
4034H~4035H	Phase A power factor PFa	F1	PF = Rx	float	R
4036H~4037H	Phase B power factor PFb	F1	PF = Rx	float	R
4038H~4039H	Phase C power factor PFc	F1	PF = Rx	float	R
403AH~403BH	System power factor PFsum	F1	PF = Rx	float	R
403CH~403DH	Voltage unbalance factor U_unbl	F1	Unbalance = Rx × 100%	float	R
403EH~403FH	Current unbalance factor I_unbl	F1	Unbalance = Rx × 100%	float	R
4040H~4041H	Load characteristic(L/C/R)	F1	76.0/67.0/82.0(ASCII)	float	R
4042H~4043H	Power demand	F1	$P=R_{xx}(PT1/PT2) \times (CT1/CT2)$	float	R
4044H~4045H	Reactive power demand	F1	$P=R_{xx}(PT1/PT2) \times (CT1/CT2)$	float	R
4046H~4047H	Apparent power demand	F1	$P=R_{xx}(PT1/PT2) \times (CT1/CT2)$	float	R

Note:

when CT2 = 5, calculating use CT2 = 5 in the formula, others use CT2 = 1 in the formula.

Real time energy measurement

Data stored in this block can be preset or cleared.

Function code: 03H for reading, 10H for writing. Data type: dword.

It can be set as primary energy or secondary energy according to user. Please

refer to F7, F8, and F9 for more details about the relationship between numerical value in the register and the real physical value.

Table 6-32

Address	Parameter	Code	Range	Data type	Property
4048H~4049H	Energy IMP	F4/F7	0~999999999	dword	R/W
404AH~404BH	Energy EXP	F4/F7	0~999999999	dword	R/W
404CH~404DH	Reactive energy IMP	F5/F8	0~999999999	dword	R/W
404EH~404FH	Reactive energy EXP	F5/F8	0~999999999	dword	R/W
4050H~4051H	Energy TOTAL	F4/F7	0~999999999	dword	R/W
4052H~4053H	Energy NET	F4/F7	-999999999~999999999	dword	R/W
4054H~4055H	Reactive energy TOTAL	F5/F8	0~999999999	dword	R/W
4056H~4057H	Reactive energy NET	F5/F8	-999999999~999999999	dword	R/W
4058H~4059H	Apparent energy	F6/F9	0~999999999	dword	R/W
4620H~4621H	Phase A Energy IMP	F4/F7	0~999999999	dword	R/W
4622H~4623H	Phase A Energy EXP	F4/F7	0~999999999	dword	R/W
4624H~4625H	Phase B Energy IMP	F4/F7	0~999999999	dword	R/W
4626H~4627H	Phase B Energy EXP	F4/F7	0~999999999	dword	R/W
4628H~4629H	Phase C Energy IMP	F4/F7	0~999999999	dword	R/W
462AH~462BH	Phase C Energy EXP	F4/F7	0~999999999	dword	R/W
462CH~462DH	Phase A Reactive energy IMP	F5/F8	0~999999999	dword	R/W
462EH~462FH	Phase A Reactive energy EXP	F5/F8	0~999999999	dword	R/W
4630H~4631H	Phase B Reactive energy IMP	F5/F8	0~999999999	dword	R/W
4632H~4633H	Phase B Reactive energy EXP	F5/F8	0~999999999	dword	R/W
4634H~4635H	Phase C Reactive energy IMP	F5/F8	0~999999999	dword	R/W
4636H~4637H	Phase C Reactive energy EXP	F5/F8	0~999999999	dword	R/W
4638H~4639H	Phase A Apparent energy	F6/F9	0~999999999	dword	R/W

463AH~463BH	Phase B Apparent energy	F6/F9	0-999999999	dword	R/W
463CH~463DH	Phase C Apparent energy	F6/F9	0-999999999	dword	R/W
On 1 number of electric power					
463EH~466DH	Sequence with system electricity+Split phase electricity		0-999999999	dword	R/W
On 2 number of electric power					
466EH~469DH	Sequence with system electricity+Split phase electricity		0-999999999	dword	R/W
On 3 number of electric power					
469EH~46CDH	Sequence with system electricity+Split phase electricity		0-999999999	dword	R/W
On 4 number of electric power					
46CEH~46FDH	Sequence with system electricity+Split phase electricity		0-999999999	dword	R/W
On 5 number of electric power					
46FEH~472DH	Sequence with system electricity+Split phase electricity		0-999999999	dword	R/W
On 6 number of electric power					
472EH~475DH	Sequence with system electricity+Split phase electricity		0-999999999	dword	R/W
On 7 number of electric power					
475EH~478DH	Sequence with system electricity+Split phase electricity		0-999999999	dword	R/W

Harmonics

THD, Harmonics, odd HD, even HD, Crest Factor, THFF, K factor etc are all stored here. The data type is "word". Voltage parameters refer to line voltage when it is set to "2LL/3LL" and phase voltage for others. Function code: 03H for reading.

Table 6-33

Address	Parameter	Code	Range	Data type	Property
The following are the THD of voltage and current					
405AH	THD_V1 of V1(V12)	F18	>=0	word	R
405BH	THD_V1 of V2(V31)	F18	>=0	word	R
405CH	THD_V1 of V3(V23)	F18	>=0	word	R
405DH	Average THD_V	F18	>=0	word	R
405EH	THD_I1	F18	>=0	word	R
405FH	THD_I2	F18	>=0	word	R
4060H	THD_I3	F18	>=0	word	R
4061H	Average THD_I	F18	>=0	word	R
Voltage Harmonics, even HD, odd HD, Crest Factor are shown as below					
4062H~407FH	Harmonics of V1(V12) (the 2 nd to 31 st)	F19	>=0	word	R
4500H~451FH	Harmonics of V1(V12) (the 32 nd to 63 rd)	F19	>=0	word	R
4080H	Odd HD of V1(V12)	F20	>=0	word	R
4081H	Even HD of V1(V12)	F21	>=0	word	R
4082H	Crest Factor of V1(V12)	F22	0~65535	word	R
4083H	THFF of V1(V12)	F24	>=0	word	R
4084H~40A5H	Parameters of V2(V31)	Same as V1		word	R
4520H~453FH	Harmonics of V2(V31) (the 32 nd to 63 rd)	F19	>=0	word	R
40A6H~40C7H	Parameters of V3(V23)	Same as V1		word	R
4540H~455FH	Harmonics of V3(V23) (the 32 nd to 63 rd)	F19	>=0	word	R
Current Harmonics, even HD, odd HD, K factor are shown as below					
40C8H~40E5H	Harmonics of I1 (the 2 nd to 31 st)	F19	>=0	word	R
4560H~457FH	Harmonics of I1 (the 32 nd to 63 rd)	F19	>=0	word	R
40E6H	Odd HD of I1	F20	>=0	word	R

Address	Parameter	Code	Range	Data type	Property
40E7H	Even HD of I1	F21	>=0	word	R
40E8H	K Factor of I1	F23	0~65535	word	R
40E9H~4109H	Parameters of I2	Same as I1		word	R
4580H~459FH	Harmonics of I2 (the 32 nd to 63 rd)	F19	>=0	word	R
410AH~412AH	Parameters of I3	Same as I1		word	R
45A0H~45BFH	Harmonics of I3 (the 32 nd to 63 rd)	F19	>=0	word	R

Note:

When selecting 400Hz type, harmonics support 2nd ~ 15th;

MAX/MIN records

MAX/MIN value and time stamp. Function code: 03H for reading.

Table 6-34

Address	Parameter	Code	Range	Data type	Property
4136H	MAX of V1	F11	-32768~32767	int	R
4137H~413CH	Time stamp: yyyy:mm: dd:hh:mm:ss	F3	time	int	R
413DH	MAX of V2	F11	-32768~32767	int	R
413EH~4143H	Time stamp: yyyy:mm: dd:hh:mm:ss	F3	time	int	R
4144H	MAX of V3	F11	-32768~32767	int	R
4145H~414AH	Time stamp: yyyy:mm: dd:hh:mm:ss	F3	time	int	R
414BH	MAX of V12	F11	-32768~32767	int	R
414CH~4151H	Time stamp: yyyy:mm: dd:hh:mm:ss	F3	time	int	R
4152H	MAX of V23	F11	-32768~32767	int	R
4153H~4158H	Time stamp: yyyy:mm: dd:hh:mm:ss	F3	time	int	R
4159H	MAX of V31	F11	-32768~32767	int	R

Address	Parameter	Code	Range	Data type	Property
415AH~415FH	Time stamp: yyyy:mm: dd:hh:mm:ss	F3	time	int	R
4160H	MAX of I1	F12	-32768~32767	int	R
4161H~4166H	Time stamp: yyyy:mm: dd:hh:mm:ss	F3	time	int	R
4167H	MAX of I2	F12	-32768~32767	int	R
4168H~416DH	Time stamp: yyyy:mm: dd:hh:mm:ss	F3	time	int	R
416EH	MAX of I3	F12	-32768~32767	int	R
416FH~4174H	Time stamp: yyyy:mm: dd:hh:mm:ss	F3	time	int	R
4175H	MAX of system power	F13	-32768~32767	int	R
4176H~417BH	Time stamp: yyyy:mm: dd:hh:mm:ss	F3	time	int	R
417CH	MAX of system reactive power	F14	-32768~32767	int	R
417DH~4182H	Time stamp: yyyy:mm: dd:hh:mm:ss	F3	time	int	R
4183H	MAX of system apparent power	F15	-32768~32767	int	R
4184H~4189H	Time stamp: yyyy:mm: dd:hh:mm:ss	F3	time	int	R
418AH	MAX of power factor	F16	-32768~32767	int	R
418BH~4190H	Time stamp: yyyy:mm: dd:hh:mm:ss	F3	time	int	R
4191H	MAX of frequency	F10	-32768~32767	int	R
4192H~4197H	Time stamp: yyyy:mm: dd:hh:mm:ss	F3	time	int	R
4198H	MAX of power demand	F13	-32768~32767	int	R
4199H~419EH	Time stamp: yyyy:mm: dd:hh:mm:ss	F3	time	int	R
419FH	MAX of reactive power demand	F14	-32768~32767	int	R

Address	Parameter	Code	Range	Data type	Property
41A0H~41A5H	Time stamp: yyyy:mm:dd:hh:mm:ss	F3	time	int	R
41A6H	MAX of apparent power demand	F15	-32768~32767	int	R
41A7H~41ACH	Time stamp: yyyy:mm:dd:hh:mm:ss	F3	time	int	R
41ADH	MAX of voltage unbalance factor	F17	-32768~32767	int	R
41AEH~41B3H	Time stamp: yyyy:mm:dd:hh:mm:ss	F3	time	int	R
41B4H	MAX of current unbalance factor	F17	-32768~32767	int	R
41B5H~41BAH	Time stamp: yyyy:mm:dd:hh:mm:ss	F3	time	int	R
41BBH	MAX of V1(V12) THD	F18	-32768~32767	int	R
41BCH~41C1H	Time stamp: yyyy:mm:dd:hh:mm:ss	F3	time	int	R
41C2H	MAX of V2(V31) THD	F18	-32768~32767	int	R
41C3H~41C8H	Time stamp: yyyy:mm:dd:hh:mm:ss	F3	time	int	R
41C9H	MAX of V3(V23) THD	F18	-32768~32767	int	R
41CAH~41CFH	Time stamp: yyyy:mm:dd:hh:mm:ss	F3	time	int	R
41D0H	MAX of I1 THD	F18	-32768~32767	int	R
41D1H~41D6H	Time stamp: yyyy:mm:dd:hh:mm:ss	F3	time	int	R
41D7H	MAX of I2 THD	F18	-32768~32767	int	R
41D8H~41DDH	Time stamp: yyyy:mm:dd:hh:mm:ss	F3	time	int	R
41DEH	MAX of I3 THD	F18	-32768~32767	int	R
41DFH~41E4H	Time stamp: yyyy:mm:dd:hh:mm:ss	F3	time	int	R

The addresses for the MIN value of the above parameters are located in 41E5H to 4293H. They have the same format as the MAX value.

Note: The MAX and MIN Frequency value should use word data type(0~65535).

Sequence component

U1 (U12), I1 are consisting of real part and complex part. They have positive sequence, negative sequence and zero sequence. Data type is "int". Function code: 03H for reading.

Table 6-35

Address	Parameter	Code	Range	Data type	Property
4294H	positive sequence real part of UA	F11	-32768~32767	int	R
4295H	positive sequence complex part of UA	F11	-32768~32767	int	R
4296H	negative sequence real part of UA	F11	-32768~32767	int	R
4297H	negative sequence complex part of UA	F11	-32768~32767	int	R
4298H	zero sequence real part of UA	F11	-32768~32767	int	R
4299H	zero sequence complex part of UA	F11	-32768~32767	int	R
429AH	positive sequence real part of IA	F12	-32768~32767	int	R
429BH	positive sequence complex part of IA	F12	-32768~32767	int	R
429CH	negative sequence real part of IA	F12	-32768~32767	int	R
429DH	negative sequence complex part of IA	F12	-32768~32767	int	R
429EH	zero sequence real part of IA	F12	-32768~32767	int	R
429FH	zero sequence complex part of IA	F12	-32768~32767	int	R

Phase angle

All voltage and current's phase angles corresponding to V1 (V12) are stored here. You can find out the phase sequence according to them. Data type is "word". Function code: 03H for reading.

Table 6-36

Address	Parameter	Code	Range	Data type	Property
42A0H	phase angle of V2 to V1 V1/ V2(3\$4) phase angle of V23 to V12 V12/V23(3\$3)	F25	0~3600	word	R

42A1H	phase angle of V3 to V1 V1/ V3(3\$4) phase angle of V31 to V12 V12/V31 (3\$3)	F25	0~3600	word	R
42A2H	phase angle of I1 to V1 V1/ I1(3\$4) phase angle of I1 to V12 V12/I1 (3\$3)	F25	0~3600	word	R
42A3H	phase angle of I2 to V1 V1/ I2(3\$4) phase angle of I2 to V12 V12/I2 (3\$3)	F25	0~3600	word	R
42A4H	phase angle of I3 to V1 V1/ I3(3\$4) phase angle of I3 to V12 V12/I3 (3\$3)	F25	0~3600	word	R
42A5H	Reserved			word	
42A6H	Reserved			word	
42A7H	Reserved			word	
42A8H	Reserved			word	

Alarming records

There are 16 groups of records with the same format. Function code: 03H for reading, 10H for writing. Please refer to Chapter 4 for more details.

Table 6-37

Address	Parameter	Code	Range	Data type	Property
42A9H	First group: alarming status	F1	0~65535	word	R
42AAH	First group: alarming parameter code	F1	0~79	word	R
42ABH	First group: over/under limit or reset value	F10~F18	Related with parameters	word	R

42ACH~42B2H	First group: Time stamp: yyyy:mm:dd:hh:mm:ss:ms	F3		word	R
42B3H~42BCH	Second group	Same as the first group			
42BDH~42C6H	Third group	Same as the first group			
42C7H~42D0H	Fourth group	Same as the first group			
42D1H~42DAH	Fifth group	Same as the first group			
42DBH~42E4H	Sixth group	Same as the first group			
42E5H~42EEH	Seventh group	Same as the first group			
42EFH~42F8H	Eighth group	Same as the first group			
42F9H~4302H	Ninth group	Same as the first group			
4303H~430CH	Tenth group	Same as the first group			
430DH~4316H	Eleventh group	Same as the first group			
4317H~4320H	Twelfth group	Same as the first group			
4321H~432AH	Thirteenth group	Same as the first group			
432BH~4334H	Fourteenth group	Same as the first group			
4335H~433EH	Fifteenth group	Same as the first group			
433FH~4348H	Sixteenth group	Same as the first group			

Counting number of I/O Modules

DI are arranged according to expanded I/O module addresses, user can check the counting number of DI along with those modules. The DI counting records are stored in a non-volatile memory and will not be erased during power off. They can be reset via communication and panel. Data type is "dword". Function code: 03H for reading.

Table 6-38

Address	Parameter	Code	Range	Data type	Property
AXM-IO11					
4349H~434AH	DI1 pulse counter number	F1	0~4294967295	dword	R
434BH~434CH	DI2 pulse counter number	F1	0~4294967295	dword	R
434DH~434EH	DI3 pulse counter number	F1	0~4294967295	dword	R
434FH~4350H	DI4 pulse counter number	F1	0~4294967295	dword	R
4351H~4352H	DI5 pulse counter number	F1	0~4294967295	dword	R

Address	Parameter	Code	Range	Data type	Property
4353H~4354H	DI6 pulse counter number	F1	0~4294967295	dword	R
AXM-IO21					
4355H~4356H	DI7 pulse counter number	F1	0~4294967295	dword	R
4357H~4358H	DI8 pulse counter number	F1	0~4294967295	dword	R
4359H~435AH	DI9 pulse counter number	F1	0~4294967295	dword	R
435BH~435CH	DI10 pulse counter number	F1	0~4294967295	dword	R
AXM-IO31					
435DH~435EH	DI11 pulse counter number	F1	0~4294967295	dword	R
435FH~4360H	DI12 pulse counter number	F1	0~4294967295	dword	R
4361H~4362H	DI13 pulse counter number	F1	0~4294967295	dword	R
4363H~4364H	DI14 pulse counter number	F1	0~4294967295	dword	R
AXM-IO12					
4365H~4366H	DI15 pulse counter number	F1	0~4294967295	dword	R
4367H~4368H	DI16 pulse counter number	F1	0~4294967295	dword	R
4369H~436AH	DI17 pulse counter number	F1	0~4294967295	dword	R
436BH~436CH	DI18 pulse counter number	F1	0~4294967295	dword	R
436DH~436EH	DI19 pulse counter number	F1	0~4294967295	dword	R
436FH~4370H	DI20 pulse counter number	F1	0~4294967295	dword	R
AXM-IO22					
4371H~4372H	DI21 pulse counter number	F1	0~4294967295	dword	R
4373H~4374H	DI22 pulse counter number	F1	0~4294967295	dword	R
4375H~4376H	DI23 pulse counter number	F1	0~4294967295	dword	R
4377H~4378H	DI24 pulse counter number	F1	0~4294967295	dword	R
AXM-IO32					
4379H~437AH	DI25 pulse counter number	F1	0~4294967295	dword	R
437BH~437CH	DI26 pulse counter number	F1	0~4294967295	dword	R
437DH~437EH	DI27 pulse counter number	F1	0~4294967295	dword	R
437FH~4380H	DI28 pulse counter number	F1	0~4294967295	dword	R

AI input value

The output of AI is mapped to the range of 0~4095 according to its sampling value using some algorithm. Data type is “word”. Function code: 03H for reading. Please refer to Chapter 5 Extended Modules for more details.

Table 6-39

Address	Parameter	Code	Range	Data type	Property
4385H	AI1 sampling value	F1	0~4095	word	R
4386H	AI2 sampling value	F1	0~4095	word	R
4387H	AI3 sampling value	F1	0~4095	word	R
4388H	AI4 sampling value	F1	0~4095	word	R

AO output

The output of AO is the actual value of output. There are 2 output options for AO - V or mA. Over/under limit or Data type is "float". Function code: 03H for reading. Please refer to Chapter 5 Extended Modules for more details.

Table 6-40

Address	Parameter	Code	Range	Data type	Property
4389H - 438AH	Value of A01	F1		float	R
438BH - 438CH	Value of A02	F1		float	R
438DH - 438EH	Value of A03	F1		float	R
438FH - 4390H	Value of A04	F1		float	R

SOE Records

There are 20 groups of records with the same format. Function code: 03H for reading. Before gathering SOE records, the selected I/O module must be SOE enabled. If the SOE enabled I/O module is not connected, SOE record logs will not be collected. Please refer to Chapter 5 Extended Modules for more details.

Table 6-41

Address	Parameter	Code	Range	Data type	Property
4399H~439FH	First group: time stamp: yyyy:mm:dd:hh:mm:ss:ms	F3		word	R
43A0H	First group: DI status	F1		word	R
43A1H~4438H	2 nd to 20 th group			word	R

4439H	I/O module of SOE	F1	0:none; 1:AXM-IO11; 2:AXM-IO21; 3:AXM-IO31; 4:AXM-IO12; 5:AXM-IO22; 6:AXM-IO32	word	R
-------	-------------------	----	--	------	---

Current demand

Include real-time current demand, the maximum current demand and time of occurrence. Function code: 03H for reading.

Table 6-42

Address	Parameter	Code	Range	Data type	Property
4600H-4601H	Phase A current demand	F1	I=Rx×(CT1/CT2)	float	R
4602H-4603H	Phase B current demand	F1	I=Rx×(CT1/CT2)	float	R
4604H-4605H	Phase C current demand	F1	I=Rx×(CT1/CT2)	float	R
4606H	Max of Phase A current demand	F12	-32768~32767	int	R
4607-460CH	Time stamp: yyyy:mm:dd:hh:mm:ss	F3	Time	int	R
460DH	Max of Phase B current demand	F12	-32768~32767	int	R
460E-4613H	Time stamp: yyyy:mm:dd:hh:mm:ss	F3	Time	int	R
4614H	Max of Phase C current demand	F12	-32768~32767	int	R
4615-461AH	Time stamp: yyyy:mm:dd:hh:mm:ss	F3	Time	int	R
4F02H	MESH Status		0:unnorml or not connect ; 0xaa: normal	uint16	R
4F03H-4F0AH	MESH MAC address		16 ASCII(from high byte to low byte)	uint16	R
4F0BH-4F14H	MESH identifier		20ASCII (form high byte to low byte)	uint16	R

DI Status

Current DI status, if related I/O module isn't connected, the DI status will be set to 0. Function code: 02H for reading.

Table 6-43

Address	Parameter	Range	Data type
AXM-IO11			
0000H	DI1	1=ON,0=OFF	bit
0001H	DI2	1=ON,0=OFF	bit
0002H	DI3	1=ON,0=OFF	bit
0003H	DI4	1=ON,0=OFF	bit
0004H	DI5	1=ON,0=OFF	bit
0005H	DI6	1=ON,0=OFF	bit
AXM-IO21			
0006H	DI7	1=ON,0=OFF	bit
0007H	DI8	1=ON,0=OFF	bit
0008H	DI9	1=ON,0=OFF	bit
0009H	DI10	1=ON,0=OFF	bit
AXM-IO31			
000AH	DI11	1=ON,0=OFF	bit
000BH	DI12	1=ON,0=OFF	bit
000CH	DI13	1=ON,0=OFF	bit
000DH	DI14	1=ON,0=OFF	bit
AXM-IO12			
000EH	DI15	1=ON,0=OFF	bit
000FH	DI16	1=ON,0=OFF	bit
0010H	DI17	1=ON,0=OFF	bit
0011H	DI18	1=ON,0=OFF	bit
0012H	DI19	1=ON,0=OFF	bit
0013H	DI20	1=ON,0=OFF	bit
AXM-IO22			
0014H	DI21	1=ON,0=OFF	bit
0015H	DI22	1=ON,0=OFF	bit

Address	Parameter	Range	Data type
0016H	DI23	1=ON,0=OFF	bit
0017H	DI24	1=ON,0=OFF	bit
AXM-IO32			
0018H	DI25	1=ON,0=OFF	bit
0019H	DI26	1=ON,0=OFF	bit
001AH	DI27	1=ON,0=OFF	bit
001BH	DI28	1=ON,0=OFF	bit

Relay status

Function code: 01H for reading, 05H for controlling output.

Table 6-44

Address	Parameter	Range	Data type
AXM-IO11			
0000H	Relay1	1=ON,0=OFF	bit
0001H	Relay2	1=ON,0=OFF	bit
AXM-IO31			
0002H	Relay3	1=ON,0=OFF	bit
0003H	Relay4	1=ON,0=OFF	bit
AXM-IO12			
0004H	Relay5	1=ON,0=OFF	bit
0005H	Relay6	1=ON,0=OFF	bit
AXM-IO32			
0006H	Relay7	1=ON,0=OFF	bit
0007H	Relay8	1=ON,0=OFF	bit

6.3.8 Data Logging

Data Logging Setting

In order to generate historical logs for the selected parameters, users should program the meter so that selected parameters from the corresponding Modbus registers can be copied to the historical log record. Since certain

parameters occupy two registers, to supplement this, the programmable settings for the historical logs contain a list of descriptors. Each descriptor lists the number of Modbus registers for the specified parameter. By combining these two lists, the historical log record can be interpreted.

For example: Registers 4002H and 4003H are programmed to be recorded by the historical log. Since 2 registers are used, the corresponding descriptor is set as 2. These registers program the log to record "Volts AN."

The historical log programmable settings are comprised of 3 blocks, one for each log. Each log works identical to each other; therefore, only historical log 1 is described here. All register addresses in this section are shown within the address range of historical log 1.

1100H-11DFH (Historical Log 1)

11C0H-127FH (Historical Log 2)

1280H-133FH (Historical Log 3)

Block Size: 192 registers per log (384 bytes)

Data Log Setting's address map :

Table 6-45

1100H - 1101H	1102H – 1176H	1177H – 11b1H	11B2H - 11B5H
Header	Register List	Item Descriptor List	Logging Timer setting

The following are the details.

1) Header:

Registers 1100H-1101H

Size 2 Registers

Table 6-46

Address	1100H		1101H	
	0(low byte)	1(high byte)	2(low byte)	3(high byte)
Value	Sectors	Registers	Interval	

Registers: The number of registers to log in the record range from {0-117}. The size of the record in memory is $[12 + (\text{Registers} \times 2)]$.

Sectors: The number of memory sectors allocated to this log. Each sector is 64kb in size. 100 sectors are available for allocation among the three historical logs. Valid allocation range is from 0~100 (When the sector is set 0, this log is disable).

Interval: The data capture interval for historical log records. Valid time interval can be set from 0-1440 minutes. When the interval is set to 0, this log is disable.

Note:

When sectors or Register or Interval is zero ,this log is disable.

2) Register List:

Registers: 1102H-1176H

Size: 1 or 2 register(s) per parameter, 117 available registers per historical log.

The register list controls which Modbus registers are recorded in each historical log record. Since many parameters, such as Voltage, Energy, etc., take up more than 1 register, multiple registers are allocated for those parameters.

For example: In order to record "Volts AN" into the historical log, Volts AN's Modbus address (4002H and 4003H) are assigned and programmed to the log record list so that information can be stored into the historical log registers.

- Each unused register item should be set to 0000H or FFFFH to indicate no parameters are associated with them.
- The actual size of the record, and the number of items in the register list which are used, is determined by the registers in the header.
- Valid register address ranges that can be recorded in the historical log registers are 4000H-412BH, 4294H-42A8H, 4349H-4398H, 4500H-461BH, 4620H-463DH.

3) Item Descriptor List:

Registers: 1177H– 11B1H

Size: 1 byte per item, 117 bytes (59 registers)

While the register list describes what to log, the Item descriptor list describes how to interpret that information. Each descriptor describes how many Modbus addresses are used to describe a parameter. Either 1 or 2 addresses will be used for each parameter.

For example: If the first descriptor is 2, and the second descriptor is 1, then the first 2 register items belong to the 1st descriptor, and the 3rd register item belongs to the 2nd descriptor.

NOTE: As can be seen from the example above, it is not a 1-to-1 relation between the register list and the descriptor list. A single descriptor may refer to two register items.

4) Logging Timer setting

If data logging only record one period data, or only start from one specific time, corresponding time and logging mode should be set then data logging can work well.

Modbus address 11B2H is used as the logging mode select. When value is 0, logging mode is set to mode1, without time setting. When value is 1, logging mode is set to mode2, so 11B3H-11B5H (start year, month, day, hour, minute, and second) and 11B6H-11B8H (end year, month, day, hour, minute, and second) should be set. When value is 2, logging mode is set to mode3, so only 11B4H (hour) and 11B5H (minute) should be set. How data logging works is in Chapter 4.

Registers 11B3H-11B5H(start time)

11B6H-11B8H(end time)

Size 2 Registers

Byte	0	1	2	3	4	5
value	month	year	hour	day	second	minute

Log Status Block

The Log Status Block describes the current status of the log in question.

Table 6-47

Address	Parameter	Range	Data type	Property
6100H~6101H	Max Records	0~468104	dword	R
6102H~6103H	Used Records	1~468104	dword	R
6104H	Record Size	14 ~246	word	R
6105H	Reserved		word	R
6106H~6108H	First Record Time stamp		word	R
6109H~610BH	Last Record Time stamp		word	R
6200H~620BH	Data logging 2 status	Same as the first group		
6300H~630BH	Data logging 3 status	Same as the first group		

Max Records: The maximum number of records the log can hold given the record size and sector allocation.

Used Records: The number of records stored in the log. This number will equal the Max Records when the log has filled. This value will be set to 1 when the log is reset.

Record Size: The number of bytes in this record, including the time stamp.

The record's format in the meter is: record number(4bytes)+ time stamp(6bytes) + [data1~dataN](2Nbytes) + CRC(2bytes).

First Record Time stamp: Time stamp of the oldest record.

Last Record Time stamp: Time stamp of the newest record.

Log Retrieval Block

The log retrieval block consists of 2 parts: the header and the window. The header is used to verify the data shown within the requested log window. The window is a sliding block of data that can be used to access any record in the specified log.

Registers 6000H-6003H
Size 4 Registers

Table 6-48

Address	Parameter	Property	Format	Description
6000H	Log type	R/W	Nnnnnnnn	log type
			ssssssss	reserve
6001H	Record number, status	R/W	Nnnnnnnn	record number
			wwwwwwww	status
6002H~6003H	offset	R/W		
6004H~607EH	window	R		

Log type: The log to be retrieved. Write this value to set which log is being retrieved.

- 0 -Historical Log 1
- 1 -Historical Log 2
- 2 -Historical Log 3

Records number: The number of records that fit within a window. This value is settable, any number less than a full window may be used. This number tells the retrieving program how many records to expect to be fetched in the window. (record number x Record Size) = bytes used in the window. This value should be $((123 \times 2) / \text{Record Size})$, rounded down. The greater this number is, the faster the retrieving speed is.

For example, with a record size of 50, the Records number = $((123 \times 2) / 50) = 4.92 \approx 4$.

Status: The status of the current window. Since the time to prepare a window may exceed an acceptable Modbus delay (1 second), this acts as a ready status flag to notify when the window is ready for retrieval. When this value indicates that the window is not ready, the data in the window should be ignored. Window Status is Read-only, any writes are ignored.

This value also indicates the memory erasing status when setting the date logging settings.

BH Window is Ready

FFH Window is Not Ready

AAH memory is erasing

BBH memory erasing is finished

CXH register list is setted error.

X:bit0 1, register list is setted error in datalogging 1;

bit1 1,register list is setted error in datalogging 2;

bit2 1,register list is setted error in datalogging 3.

For example,0xC6H,register lists are error in datalogging2 and 3

Offset: The offset of the record number of the first record in the data window and the record number of the "first record time stamp". Setting this value controls which records will be available in the data window. When the log is retrieved, the first (oldest) record is "latched." This means that offset 0 will always point to the oldest record at the time of latching.

Window: The actual data of the records, arranged according to the above settings.

Note: If the logging timer is disabled, the first recording sector will be erased when the log is full. Therefore, user should not read the whole log when the used record number is near to the max record number. Under this condition, user should read the "Used Records" field and compare it to the previous "Used

Records" field from the last reading before retrieving the information and reading the window.

If the current "Used Records" field is greater than the "Used Records" field from the last reading and if the "Offset" field is less than the difference between the current and previous "Used Records" field, the first sector has been erased and the difference between the "Used Records" field should be subtracted from the recording number.

If the "Offset" field is greater than the difference between the current and previous "Used Records" field, the "Offset" number should be subtracted from the recording number.

To avoid this situation, user should read the log before it is almost full.

For example: Data logging 1 has 3 sectors and each has 448 records, and the total records are 1344. If you press the "Read All" button when the "Used Records" number is at 1340 and if the first sector is erased before the information is transferred to the computer, the data stored in this sector is erased permanently and cannot be retrieved. If the records from the first sector can be retrieved before it gets erased, the new value of "Offset" will equal to the original "Offset" field minus the value of the difference between the current and previous "Used Records" field.

Data logging operation examples

The following example illustrates a data logging operation. The example makes the following assumptions:

- The log is Historical Log 1.
- The log contains VAN, VBN, VCN (12 bytes), the interval is 1min, the sectors is 10, the registers is 6, the logging timer function is disabled.
- Retrieval is starting at record offset 0 (oldest record).

- No new records are recorded to the log during the log retrieval process.

a) Data logging settings

Now set the data log 1 according to the assumptions:

1. Set the data log with VAN, VBN, VCN, here we should set their modbus address 0x4002,0x4003,0x4004,0x4005,0x4006 and 0x4007 to 0x1102, 0x1103, 0x1104, 0x1105, 0x1106 and 0x1107. And the discripiter is 2,so set the 0x0202 and 0x0200 to 0x1177 and 0x1178.
2. The register is 6 and sector is 10, so we set 0x060A to 0x1100.
3. The interval is 1min , so set the 0x0001 to 0x1101.
4. The logging timer function is disabled, so set the 0 to 0x11B9.

b) Log Retrieval Procedure

The following procedure documents how to retrieve a single log from the oldest record to the newest record.

1. Compute the number of records per window, as follows:

$$\text{RecordsPerWindow} = (246 \setminus \text{RecordSize})=246 \setminus 24=10.$$

2. Write the Records per window and Record offset, in this example set the 0x0A0B and 0x0000 to 0x6001d and 0x6002.

This step tells the meter what data to return in the window.

3. Read the record window status from 0x6001.
 - If the Window Status is 0xFF, go to step 2.
 - If the Window Status is 0x0B, Read the data window.
4. Read the data window and compute next Expected Record offset.

- Compute the next expected record offset by adding Records Per Window and go to step 2.
- If there are no remaining records after the current record window, stop reading.

6.3.9 Time of use

Data address of TOU energy

The data address save the parameter of energy, which includes Data address of last month TOU energy, Data address of current month TOU energy, Data address of TOU parameter setting and Data address of TOU default parameter. Except for the data address of TOU default parameter, the data address is read with 03 code, preset with 16 code.

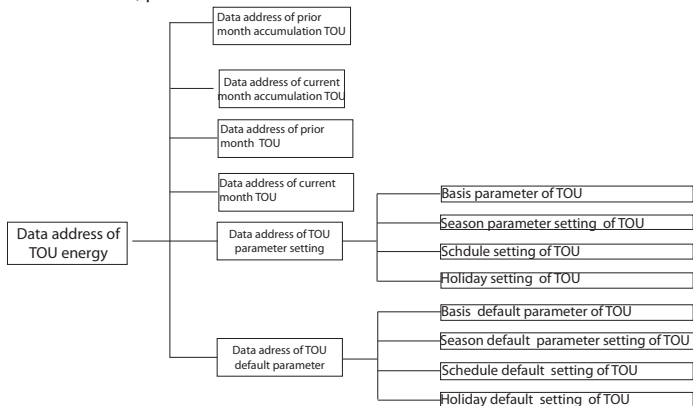

Fig 6-1 Division plan of TOU energy

Table 6-49

address	parameter	range	Data type	Type of access
Current month accumulation TOU energy				
7200H~7201H	Ep_imp(sharp)	0~999999999	Dword	R/W
7202H~7203H	Ep_exp(sharp)	0~999999999	Dword	R/W
7204H~7205H	Eq_im(sharp)	0~999999999	Dword	R/W
7206H~7207H	Eq_exp(sharp)	0~999999999	Dword	R/W
7208H~7209H	Es(sharp)	0~999999999	Dword	R/W
720AH~720BH	Ep_imp(peak)	0~999999999	Dword	R/W
720CH~720DH	Ep_exp(peak)	0~999999999	Dword	R/W
720EH~720FH	Eq_imp(peak)	0~999999999	Dword	R/W
7210H~7211H	Eq_exp(peak)	0~999999999	Dword	R/W
7212H~7213H	Es(peak)	0~999999999	Dword	R/W
7214H~7215H	Ep_imp(valley)	0~999999999	Dword	R/W
7216H~7217H	Ep_exp(valley)	0~999999999	Dword	R/W
7218H~7219H	Eq_imp(valley)	0~999999999	Dword	R/W
721AH~721BH	Eq_exp(valley)	0~999999999	Dword	R/W
721CH~721DH	Es(valley)	0~999999999	Dword	R/W
721EH~721FH	Ep_imp(normal)	0~999999999	Dword	R/W
7220H~7221H	Ep_exp(normal)	0~999999999	Dword	R/W
7222H~7223H	Eq_imp(normal)	0~999999999	Dword	R/W
7224H~7225H	Eq_exp(normal)	0~999999999	Dword	R/W
7226H~7227H	Es(normal)	0~999999999	Dword	R/W
7228H~7229H	Ep_imp(sum)	0~999999999	Dword	R/W
722AH~722BH	Ep_exp(sum)	0~999999999	Dword	R/W
722CH~722DH	Eq_imp(sum)	0~999999999	Dword	R/W
722EH~722FH	Eq_exp(sum)	0~999999999	Dword	R/W
7230H~7231H	Es(sum)	0~999999999	Dword	R/W

address	parameter	range	Data type	Type of access
Current month accumulation TOU energy				
7232H~7233H	Ep_imp(sharp)	0~999999999	Dword	R/W
7234H~7235H	Ep_exp(sharp)	0~999999999	Dword	R/W
7236H~7237H	Eq_imp(sharp)	0~999999999	Dword	R/W
7238H~7239H	Eq_exp(sharp)	0~999999999	Dword	R/W
723AH~723BH	Es(sharp)	0~999999999	Dword	R/W
723CH~723DH	Ep_imp(peak)	0~999999999	Dword	R/W
723EH~723FH	Ep_exp(peak)	0~999999999	Dword	R/W
7240H~7241H	Eq_imp(peak)	0~999999999	Dword	R/W
7242H~7243H	Eq_exp(peak)	0~999999999	Dword	R/W
7244H~7245H	Es(peak)	0~999999999	Dword	R/W
7246H~7247H	Ep_imp(valley)	0~999999999	Dword	R/W
7248H~7249H	Ep_exp(valley)	0~999999999	Dword	R/W
724AH~724BH	Eq_imp(valley)	0~999999999	Dword	R/W
724CH~724DH	Eq_exp(valley)	0~999999999	Dword	R/W
724EH~724FH	Es(valley)	0~999999999	Dword	R/W
7250H~7251H	Ep_imp(normal)	0~999999999	Dword	R/W
7252H~7253H	Ep_exp(normal)	0~999999999	Dword	R/W
7254H~7255H	Eq_imp(normal)	0~999999999	Dword	R/W
7256H~7257H	Eq_exp(normal)	0~999999999	Dword	R/W
7258H~7259H	Es(normal)	0~999999999	Dword	R/W
725AH~725BH	Ep_imp(sum)	0~999999999	Dword	R/W
725CH~725DH	Ep_exp(sum)	0~999999999	Dword	R/W
725EH~725FH	Eq_imp(sum)	0~999999999	Dword	R/W
7260H~7261H	Eq_exp(sum)	0~999999999	Dword	R/W
7262H~7263H	Es(sum)	0~999999999	Dword	R/W

Table 6-50

address	parameter	range	Data type	Type of access
Current month TOU energy				
7300H~7301H	Ep_imp(sharp)	0~999999999	Dword	R/W
7302H~7303H	Ep_exp(sharp)	0~999999999	Dword	R/W
7304H~7305H	Eq_im(sharp)	0~999999999	Dword	R/W
7306H~7307H	Eq_exp(sharp)	0~999999999	Dword	R/W
7308H~7309H	Es(sharp)	0~999999999	Dword	R/W
730AH~730BH	Ep_imp(peak)	0~999999999	Dword	R/W
730CH~730DH	Ep_exp(peak)	0~999999999	Dword	R/W
730EH~730FH	Eq_imp(peak)	0~999999999	Dword	R/W
7310H~7311H	Eq_exp(peak)	0~999999999	Dword	R/W
7312H~7313H	Es(peak)	0~999999999	Dword	R/W
7314H~7315H	Ep_imp(valley)	0~999999999	Dword	R/W
7316H~7317H	Ep_exp(valley)	0~999999999	Dword	R/W
7318H~7319H	Eq_imp(valley)	0~999999999	Dword	R/W
731AH~731BH	Eq_exp(valley)	0~999999999	Dword	R/W
731CH~731DH	Es(valley)	0~999999999	Dword	R/W
731EH~731FH	Ep_imp(normal)	0~999999999	Dword	R/W
7320H~7321H	Ep_exp(normal)	0~999999999	Dword	R/W
7322H~7323H	Eq_imp(normal)	0~999999999	Dword	R/W
7324H~7325H	Eq_exp(normal)	0~999999999	Dword	R/W
7326H~7327H	Es(normal)	0~999999999	Dword	R/W
7328H~7329H	Ep_imp(sum)	0~999999999	Dword	R/W
732AH~732BH	Ep_exp(sum)	0~999999999	Dword	R/W
732CH~732DH	Eq_imp(sum)	0~999999999	Dword	R/W
732EH~732FH	Eq_exp(sum)	0~999999999	Dword	R/W
7330H~7331H	Es(sum)	0~999999999	Dword	R/W

address	parameter	range	Data type	Type of access
Prior month TOU energy				
7332H~7333H	Ep_imp(sharp)	0~999999999	Dword	R/W
7334H~7335H	Ep_exp(sharp)	0~999999999	Dword	R/W
7336H~7337H	Eq_imp(sharp)	0~999999999	Dword	R/W
7338H~7339H	Eq_exp(sharp)	0~999999999	Dword	R/W
733AH~733BH	Es(sharp)	0~999999999	Dword	R/W
733CH~733DH	Ep_imp(peak)	0~999999999	Dword	R/W
733EH~733FH	Ep_exp(peak)	0~999999999	Dword	R/W
7340H~7341H	Eq_imp(peak)	0~999999999	Dword	R/W
7342H~7343H	Eq_exp(peak)	0~999999999	Dword	R/W
7344H~7345H	Es(peak)	0~999999999	Dword	R/W
7346H~7347H	Ep_imp(valley)	0~999999999	Dword	R/W
7348H~7349H	Ep_exp(valley)	0~999999999	Dword	R/W
734AH~734BH	Eq_imp(valley)	0~999999999	Dword	R/W
734CH~734DH	Eq_exp(valley)	0~999999999	Dword	R/W
734EH~734FH	Es(valley)	0~999999999	Dword	R/W
7350H~7351H	Ep_imp(normal)	0~999999999	Dword	R/W
7352H~7353H	Ep_exp(normal)	0~999999999	Dword	R/W
7354H~7355H	Eq_imp(normal)	0~999999999	Dword	R/W
7356H~7357H	Eq_exp(normal)	0~999999999	Dword	R/W
7358H~7359H	Es(normal)	0~999999999	Dword	R/W
735AH~735BH	Ep_imp(sum)	0~999999999	Dword	R/W
735CH~735DH	Ep_exp(sum)	0~999999999	Dword	R/W
735EH~735FH	Eq_imp(sum)	0~999999999	Dword	R/W
7360H~7361H	Eq_exp(sum)	0~999999999	Dword	R/W
7362H~7363H	Es(sum)	0~999999999	Dword	R/W

The address area include the max of Ep_imp, Ep_exp, Eq_im, Eq_exp, Es, Current demand and time stamp, When tariff setting parameter is sharp, peak, valley and normal. Function: 03H Read.

Table 6-51

Address	Parameter	Range	Data type	Type of access
7500H~7503H	Max of Ep_imp (sharp) demand and time stamp(format: power; year/mon; Day/Hour; Min/Sec)	-32768~32767	Int	R
7504H~7507H	Max of Ep_exp(sharp) demand and time stamp	-32768~32767	Int	R
7508H~750BH	Max of Eq_im(sharp) demand and time stamp	-32768~32767	Int	R
750CH~750FH	Max of Eq_exp(sharp) demand and time stamp	-32768~32767	Int	R
7510H~7513H	Max of Es(sharp) demand and time stamp	-32768~32767	Int	R
7514H~7517H	Max of Ia(sharp) demand and time stamp	-32768~32767	Int	R
7518H~751BH	Max of Ib(sharp) demand and time stamp	-32768~32767	Int	R
751CH~751FH	Max of Ic(sharp) demand and time stamp	-32768~32767	Int	R
7520H~7523H	Max of Ep_imp(peak) demand and time stamp	-32768~32767	Int	R
7524H~7527H	Max of Ep_exp(peak) demand and time stamp	-32768~32767	Int	R
7528H~752BH	Max of Eq_im(peak) demand and time stamp	-32768~32767	Int	R
752CH~752FH	Max of Eq_exp(peak) demand and time stamp	-32768~32767	Int	R
7530H~7533H	Max of Es(peak) demand and time stamp	-32768~32767	Int	R
7534H~7537H	Max of Ia (peak)demand and time stamp	-32768~32767	Int	R
7538H~753BH	Max of Ib (peak)demand and time stamp	-32768~32767	Int	R
753CH~753FH	Max of Ic (peak) demand and time stamp	-32768~32767	Int	R
7540H~7543H	Max of Ep_imp(valley) demand and time stamp	-32768~32767	Int	R

Address	Parameter	Range	Data type	Type of access
7544H~7547H	Max of Ep_exp(valley) demand and time stamp	-32768~32767	Int	R
7548H~754BH	Max of Eq_im(valley) demand and time stamp	-32768~32767	Int	R
754CH~754FH	Max of Eq_exp(valley) demand and time stamp	-32768~32767	Int	R
7550H~7553H	Max of Es(valley) demand and time stamp	-32768~32767	Int	R
7554H~7557H	Max of Ia (valley)demand and time stamp	-32768~32767	Int	R
7558H~755BH	Max of Ib (valley)demand and time stamp	-32768~32767	Int	R
755CH~755FH	Max of Ic (valley) demand and time stamp	-32768~32767	Int	R
7560H~7563H	Max of Ep_imp(normal) demand and time stamp	-32768~32767	Int	R
7564H~7567H	Max of Ep_exp(normal) demand and time stamp	-32768~32767	Int	R
7568H~756BH	Max of Eq_im(normal) demand and time stamp	-32768~32767	Int	R
756CH~756FH	Max of Eq_exp(normal) demand and time stamp	-32768~32767	Int	R
7570H~7573H	Max of Es(normal) demand and time stamp	-32768~32767	Int	R
7574H~7577H	Max of Ia (normal)demand and time stamp	-32768~32767	Int	R
7578H~757BH	Max of Ib (normal)demand and time stamp	-32768~32767	Int	R
757CH~757FH	Max of Ic (normal) demand and time stamp	-32768~32767	Int	R
7580H~7583H	Max of Ep_imp(all) demand and time stamp	-32768~32767	Int	R
7584H~7587H	Max of Ep_exp(all) demand and time stamp	-32768~32767	Int	R
7588H~758BH	Max of Eq_im(all) demand and time stamp	-32768~32767	Int	R
758CH~758FH	Max of Eq_exp(all) demand and time stamp	-32768~32767	Int	R
7590H~7593H	Max of Es(all) demand and time stamp	-32768~32767	Int	R
7594H~7597H	Max of Ia(all)demand and time stamp	-32768~32767	Int	R
7598H~759BH	Max of Ib(all)demand and time stamp	-32768~32767	Int	R
759CH~759FH	Max of Ic(all) demand and time stamp	-32768~32767	Int	R

The address area include Daylight saving time(DST) setting. Function: 03H Read, 10H Preset.

Table 6-52

Address	Parameter	Range	Data type	Type of access
7700H	DST enable	0: disable 1: enable	Word	R/W
7701H	DST format	0: format 1 1: format 2	Word	R/W
Format 1				
7702H	DST Start Mon	1~12	Word	R/W
7703H	DST Start Day	1~31	Word	R/W
7704H	DST Start Hour	0~23	Word	R/W
7705H	DST Start Min	0~59	Word	R/W
7706H	DST Start Adjust time (Unit: Min)	1~120 Default: 60	Word	R/W
7707H	DST Ending Mon	1~12	Word	R/W
7708H	DST Ending Day	1~31	Word	R/W
7709H	DST Ending Hour	0~23	Word	R/W
770AH	DST Ending Min	0~59	Word	R/W
770BH	DST Ending Adjust time (Unit: Min)	1~120 Default: 60	Word	R/W
Format 2				
770CH	DST Start Mon	1~12	Word	R/W
770DH	DST Start week	0~6 0: Sunday 1~6 Monday to Saturday	Word	R/W
770EH	DST Start First few weeks	1~5	Word	R/W
770FH	DST Start Hour	0~23	Word	R/W
7710H	DST Start Min	0~59	Word	R/W
7711H	DST Start Adjust time (Unit: Min)	1~120 Default: 60	Word	R/W
7712H	DST Ending Mon	1~12	Word	R/W
7713H	DST Ending Week	0~6 0: Sunday 1~6 Monday to Saturday	Word	R/W

Address	Parameter	Range	Data type	Type of access
7714H	DST Ending First few weeks	1~5	Word	R/W
7715H	DST Ending Hour	0~23	Word	R/W
7716H	DST Ending Min	0~59	Word	R/W
7717H	DST Ending Adjust time (Unit: Min)	1~120 Default: 60	Word	R/W

Data address of TOU parameter setting includes basis parameter of TOU, time zone setting parameter of TOU, time table setting parameter of TOU and holiday setting parameter of TOU. Function: 03 code, 10 reset.

Table 6-53 data address of TOU

Address	Parameter	Range	Data type	Type of access
Basis parameter of TOU				
7800H	Season Number	0~12	Word	R/W
7801H	Schedule Number	0~14	Word	R/W
7802H	Segment Number	0~14	Word	R/W
7803H	Tariff Number	0~3	Word	R/W
7804H	Weekend Setting(bit0-Sunday;bit1~bit6:Monday~Saturdaybit=1 means using energy,bit=0 means not using energy)	0~127	Word	R/W
7805H	Weekend Schedule	0~14	Word	R/W
7806H	Holiday Number	0~30	Word	R/W
7807H	Time of Use factory setting	1:enable	Word	R/W
7808H	Choice of calculation auto reset (0: End of Month)	1:enable	Word	R/W
7809H	TOU auto reset fixed date:day (default is 1)		Word	R/W
780AH	TOU auto reset fixed date:hour (default is 0)	1~31	Word	R/W
780BH	TOU auto reset fixed date:minute (default is 0)	0~23	Word	R/W

Address	Parameter	Range	Data type	Type of access
780CH	TOU auto reset fixed date:second (default is 0)	0~59	Word	R/W
780DH	TOU auto reset fixed date:second (default is 0)	0~59	Word	R/W
780EH	Error Code(default)	0: the setting of parameter is correct; 1: tariff setting error; 2: schedule setting error; 4: segment setting error; 8: season setting error; 16: parameter of season setting error 32: holiday setting error; 64: parameter of holiday setting error; 256: tariff of schedule setting error; 512: time of schedule setting error; 1024: period of schedule setting error; 048: period of weekend setting error; 4096: weekend setting error;		
Season Setting				
7820H~7822H	data and Season table Of the 1 st Season		word	R/W
7823H~7825H	data and Season table Of the 2 nd Season		word	R/W
7826H~7828H	data and Season table Of the 3 rd Season		word	R/W
7829H~782BH	data and Season table Of the 4 th Season		word	R/W
782CH~782EH	data and Season table Of the 5 th Season		word	R/W
782FH~7831H	data and Season table Of the 6 th Season		word	R/W
7832H~7834H	data and Season table Of the 7 th Season		word	R/W

Address	Parameter	Range	Data type	Type of access
7835H~7837H	data and Season table Of the 8 th Season		word	R/W
7838H~783AH	data and Season tableOf the 9 th Season		word	R/W
783BH~783DH	data and Season tableOf the 10 th Season		word	R/W
783EH~7840H	data and Season tableOf the 11 th Season		word	R/W
7841H~7843H	data and Season tableOf the 12 th Season		word	R/W
Schedule Setting				
7844H~7846H	1 st Seagment and Tariff Number of the 1 st schedule		word	R/W
7847H~7849H	2 nd Seagment and Tariff Number of the 1 st schedule		word	R/W
784AH~784CH	3 rd Seagment and Tariff Number of the 1 st schedule		word	R/W
784DH~784FH	4 th Seagment and Tariff Number of the 1 st schedule		word	R/W
7850H~7852H	5 th Seagment and Tariff Number of the 1 st schedule		word	R/W
7853H~7855H	6 th Seagment and Tariff Number of the 1 st schedule		word	R/W
7856H~7858H	7 th Seagment and Tariff Number of the 1 st schedule		word	R/W
7859H~785BH	8 th Seagmentand Tariff Number of the 1 st schedule		word	R/W
785CH~785EH	9 th Seagment and Tariff Number of the 1 st schedule		word	R/W
785FH~7861H	10 th Seagment and Tariff Number of the 1 st schedule		word	R/W
7862H~7864H	11 th Seagment and Tariff Number of the 1 st schedule		word	R/W

Address	Parameter	Range	Data type	Type of access
7865H~7867H	12 th Segment and Tariff Number of the 1 st schedule		word	R/W
7868H~786AH	13 th Segment and Tariff Number of the 1 st schedule		word	R/W
786BH~786DH	14 th Segment and Tariff Number of the 1 st schedule		word	R/W
786EH~7897H	From 1 st to 14 th Segment and Tariff Number of the 2 th schedule	The same as 1 st schedule	word	R/W
7898H~78C1H	From 1 st to 14 th Segment and Tariff Number of the 3 rd schedule	The same as 1 st schedule	word	R/W
78C2H~78EBH	From 1 st to 14 th Segment and Tariff Number of the 4 th schedule	The same as 1 st schedule	word	R/W
78ECH~7915H	From 1 st to 14 th Segment and Tariff Number of the 5 th schedule	The same as 1 st schedule	word	R/W
7916H~793FH	From 1 st to 14 th Segment and Tariff Number of the 6 th schedule	The same as 1 st schedule	word	R/W
7940H~7969H	From 1 st to 14 th Segment and Tariff Number of the 7 th schedule	The same as 1 st schedule	word	R/W
796AH~7993H	From 1 st to 14 th Segment and Tariff Number of the 8 th schedule	The same as 1 st schedule	word	R/W
7994H~79BDH	From 1 st to 14 th Segment and Tariff Number of the 9 th schedule	The same as 1 st schedule	word	R/W
79BEH~79E7H	From 1 st to 14 th Segment and Tariff Number of the 10 th schedule	The same as 1 st schedule	word	R/W
79E8H~7A11H	From 1 st to 14 th Segment and Tariff Number of the 11 th schedule	The same as 1 st schedule	word	R/W

Address	Parameter	Range	Data type	Type of access
7A12H~7A3BH	From 1 st to 14 th Segment and Tariff Number of the 12 th schedule	The same as 1 st schedule	word	R/W
7A3CH~7A65H	From 1 st to 14 th Segment and Tariff Number of the 13 th schedule	The same as 1 st schedule	word	R/W
7A66H~7A8FH	From 1 st to 14 th Segment and Tariff Number of the 14 th schedule	The same as 1 st schedule	word	R/W
Holiday Setting				
7A90H~7A92H	data and the schedule Of the 1 st holiday		word	R/W
7A93H~7A95H	data and the schedule Of the 2 nd holiday		word	R/W
7A96H~7A98H	data and the schedule Of the 3 rd holiday		word	R/W
7A99H~7A9BH	data and the schedule Of the 4 th holiday		word	R/W
7A9CH~7A9EH	data and the schedule Of the 5 th holiday		word	R/W
7A9FH~7AA1H	data and the schedule Of the 6 th holiday		word	R/W
7AA2H~7AA4H	data and the schedule Of the 7 th holiday		word	R/W
7AA5H~7AA7H	data and the schedule Of the 8 th holiday		word	R/W
7AA8H~7AAAH	data and the schedule Of the 9 th holiday		word	R/W
7AABH~7AADH	data and the schedule Of the 10 th holiday		word	R/W
7AAEH~7AB0H	data and the schedule Of the 11 th holiday		word	R/W
7AB1H~7AB3H	data and the schedule Of the 12 th holiday		word	R/W
7AB4H~7AB6H	data and the schedule Of the 13 th holiday		word	R/W

Address	Parameter	Range	Data type	Type of access
7AB7H~7AB9H	data and the schedule Of the 14 th holiday		word	R/W
7ABAH~7ABCH	data and the schedule Of the 15 th holiday		word	R/W
7ABDH~7ABFH	data and the schedule Of the 16 th holiday		word	R/W
7AC0H~7AC2H	data and the schedule Of the 17 th holiday		word	R/W
7AC3H~7AC5H	data and the schedule Of the 18 th holiday		word	R/W
7AC6H~7AC8H	data and the schedule Of the 19 th holiday		word	R/W
7AC9H~7ACBH	data and the schedule Of the 20 th holiday		word	R/W
7ACCH~7ACEH	data and the schedule Of the 21 st holiday		word	R/W
7ACFH~7AD1H	data and the schedule Of the 22 nd holiday		word	R/W
7AD2H~7AD4H	data and the schedule Of the 23 rd holiday		word	R/W
7AD5H~7AD7H	data and the schedule Of the 24 th holiday		word	R/W
7AD8H~7ADAH	data and the schedule Of the 25 th holiday		word	R/W
7ADBH~7ADDH	data and the schedule Of the 26 th holiday		word	R/W
7ADEH~7AE0H	data and the schedule Of the 27 th holiday		word	R/W
7AE1H~7AE3H	data and the schedule Of the 28 th holiday		word	R/W
7AE4H~7AE6H	data and the schedule Of the 29 th holiday		word	R/W
7AE7H~7AE9H	data and the schedule Of the 30 th holiday		word	R/W

Address	Parameter	Range	Data type	Type of access
7AEA H	Holiday setting enable		word	R/W
7AEB H	Start year holiday setting		word	R/W
7AEC H	End year holiday setting		word	R/W

The address area include ten years holiday setting, Function: 03H Read 10H Preset

Table 6-54 Data address of ten years holiday

The 1 st year Holiday address Function: 03H Read 10H Preset				
7B00H~7B02H	The 1 st holiday and schedule (format: month /day /schedule)	word		R/W
7B03H~7B05H	The 2 nd holiday and schedule	word		R/W
7B06H~7B08H	The 3 rd holiday and schedule	word		R/W
7B09H~7B0BH	The 4 th holiday and schedule	word		R/W
7B0CH~7B0EH	The 5 th holiday and schedule	word		R/W
7B0FH~7B11H	The 6 th holiday and schedule	word		R/W
7B12H~7B14H	The 7 th holiday and schedule	word		R/W
7B15H~7B17H	The 8 th holiday and schedule	word		R/W
7B18H~7B1AH	The 9 th holiday and schedule	word		R/W
7B1BH~7B1DH	The 10 th holiday and schedule	word		R/W
7B1EH~7B20H	The 11 th holiday and schedule	word		R/W
7B21H~7B23H	The 12 th holiday and schedule	word		R/W
7B24H~7B26H	The 13 th holiday and schedule	word		R/W
7B27H~7B29H	The 14 th holiday and schedule	word		R/W
7B2AH~7B2CH	The 15 th holiday and schedule	word		R/W
7B2DH~7B2FH	The 16 th holiday and schedule	word		R/W
7B30H~7B32H	The 17 th holiday and schedule	word		R/W
7B33H~7B35H	The 18 th holiday and schedule	word		R/W
7B36H~7B38H	The 19 th holiday and schedule	word		R/W
7B39H~7B3BH	The 20 th holiday and schedule	word		R/W
7B3CH~7B3EH	The 21 st holiday and schedule	word		R/W

7B3FH~7B41H	The 22 nd holiday and schedule	word	R/W
7B42H~7B44H	The 23 rd holiday and schedule	word	R/W
7B45H~7B47H	The 24 th holiday and schedule	word	R/W
7B48H~7B4AH	The 25 th holiday and schedule	word	R/W
7B4BH~7B4DH	The 26 th holiday and schedule	word	R/W
7B4EH~7B50H	The 27 th holiday and schedule	word	R/W
7B51H~7B53H	The 28 th holiday and schedule	word	R/W
7B54H~7B56H	The 29 th holiday and schedule	word	R/W
7B57H~7B59H	The 30 th holiday and schedule	word	R/W
7B5AH	The 1 st setting year	word	R/W
7B5BH	Holiday number of the 1 st year	word	R/W
The 2nd year Holiday address Function: 03H Read 10H Preset			
7B5CH~7B5EH	The 1 st holiday and schedule (format: month /day /schedule)	word	R/W
7B5FH~7B61H	The 2 nd holiday and schedule	word	R/W
7B62H~7B64H	The 3 rd holiday and schedule	word	R/W
7B65H~7B67H	The 4 th holiday and schedule	word	R/W
7B68H~7B6AH	The 5 th holiday and schedule	word	R/W
7B6BH~7B6DH	The 6 th holiday and schedule	word	R/W
7B6EH~7B70H	The 7 th holiday and schedule	word	R/W
7B71H~7B73H	The 8 th holiday and schedule	word	R/W
7B74H~7B76H	The 9 th holiday and schedule	word	R/W
7B77H~7B79H	The 10 th holiday and schedule	word	R/W
7B7AH~7B7CH	The 11 th holiday and schedule	word	R/W
7B7DH~7B7FH	The 12 th holiday and schedule	word	R/W
7B80H~7B82H	The 13 th holiday and schedule	word	R/W
7B83H~7B85H	The 14 th holiday and schedule	word	R/W
7B86H~7B88H	The 15 th holiday and schedule	word	R/W
7B89H~7B8BH	The 16 th holiday and schedule	word	R/W
7B8CH~7B8EH	The 17 th holiday and schedule	word	R/W
7B8FH~7B91H	The 18 th holiday and schedule	word	R/W
7B92H~7B94H	The 19 th holiday and schedule	word	R/W

7B95H~7B97H	The 20 th holiday and schedule	word	R/W
7B98H~7B9AH	The 21 st holiday and schedule	word	R/W
7B9BH~7B9DH	The 22 nd holiday and schedule	word	R/W
7B9EH~7BA0H	The 23 rd holiday and schedule	word	R/W
7BA1H~7BA3H	The 24 th holiday and schedule	word	R/W
7BA4H~7BA6H	The 25 th holiday and schedule	word	R/W
7BA7H~7BA9H	The 26 th holiday and schedule	word	R/W
7BAAH~7BACH	The 27 th holiday and schedule	word	R/W
7BADH~7BAFH	The 28 th holiday and schedule	word	R/W
7BB0H~7BB2H	The 29 th holiday and schedule	word	R/W
7BB3H~7BB5H	The 30 th holiday and schedule	word	R/W
7BB6H	The 2 th setting year	word	R/W
7BB7H	Holiday number of the 2 th year	word	R/W
The 3rd year Holiday address Function: 03H Read 10H Preset			
7BB8H~7BBAH	The 1 st holiday and schedule (format: month /day /schedule)	word	R/W
7BBBH~7BBDH	The 2 nd holiday and schedule	word	R/W
7BBEH~7BC0H	The 3 rd holiday and schedule	word	R/W
7BC1H~7BC3H	The 4 th holiday and schedule	word	R/W
7BC4H~7BC6H	The 5 th holiday and schedule	word	R/W
7BC7H~7BC9H	The 6 th holiday and schedule	word	R/W
7BCAH~7BCCH	The 7 th holiday and schedule	word	R/W
7BCDH~7BCFH	The 8 th holiday and schedule	word	R/W
7BD0H~7BD2H	The 9 th holiday and schedule	word	R/W
7BD3H~7BD5H	The 10 th holiday and schedule	word	R/W
7BD6H~7BD8H	The 11 th holiday and schedule	word	R/W
7BD9H~7BDBH	The 12 th holiday and schedule	word	R/W
7BDCH~7BDEH	The 13 th holiday and schedule	word	R/W
7BDFH~7BE1H	The 14 th holiday and schedule	word	R/W
7BE2H~7BE4H	The 15 th holiday and schedule	word	R/W
7BE5H~7BE7H	The 16 th holiday and schedule	word	R/W
7BE8H~7BEAH	The 17 th holiday and schedule	word	R/W

7BEBH~7BEDH	The 18 th holiday and schedule	word	R/W
7BEEH~7BF0H	The 19 th holiday and schedule	word	R/W
7BF1H~7BF3H	The 20 th holiday and schedule	word	R/W
7BF4H~7BF6H	The 21 st holiday and schedule	word	R/W
7BF7H~7BF9H	The 22 nd holiday and schedule	word	R/W
7BFAH~7BFCH	The 23 rd holiday and schedule	word	R/W
7BFDH~7BFFH	The 24 th holiday and schedule	word	R/W
7C00H~7C02H	The 25 th holiday and schedule	word	R/W
7C03H~7C05H	The 26 th holiday and schedule	word	R/W
7C06H~7C08H	The 27 th holiday and schedule	word	R/W
7C09H~7C0BH	The 28 th holiday and schedule	word	R/W
7C0CH~7C0EH	The 29 th holiday and schedule	word	R/W
7C0FH~7C11H	The 30 th holiday and schedule	word	R/W
7C12H	The 3 rd setting year	word	R/W
7C13H	Holiday number of the 3 rd year	word	R/W
The 4th year Holiday address Function: 03H Read 10H Preset			
7C14H~7C16H	The 1 st holiday and schedule (format: month /day /schedule)	word	R/W
7C17H~7C19H	The 2 nd holiday and schedule	word	R/W
7C1AH~7C1CH	The 3 rd holiday and schedule	word	R/W
7C1DH~7C1FH	The 4 th holiday and schedule	word	R/W
7C20H~7C22H	The 5 th holiday and schedule	word	R/W
7C23H~7C25H	The 6 th holiday and schedule	word	R/W
7C26H~7C28H	The 7 th holiday and schedule	word	R/W
7C29H~7C2BH	The 8 th holiday and schedule	word	R/W
7C2CH~7C2EH	The 9 th holiday and schedule	word	R/W
7C2FH~7C31H	The 10 th holiday and schedule	word	R/W
7C32H~7C34H	The 11 th holiday and schedule	word	R/W
7C35H~7C37H	The 12 th holiday and schedule	word	R/W
7C38H~7C3AH	The 13 th holiday and schedule	word	R/W
7C3BH~7C3DH	The 14 th holiday and schedule	word	R/W
7C3EH~7C40H	The 15 th holiday and schedule	word	R/W

7C41H~7C43H	The 16 th holiday and schedule	word	R/W
7C44H~7C46H	The 17 th holiday and schedule	word	R/W
7C47H~7C49H	The 18 th holiday and schedule	word	R/W
7C4AH~7C4CH	The 19 th holiday and schedule	word	R/W
7C4DH~7C4FH	The 20 th holiday and schedule	word	R/W
7C50H~7C52H	The 21 st holiday and schedule	word	R/W
7C53H~7C55H	The 22 nd holiday and schedule	word	R/W
7C56H~7C58H	The 23 rd holiday and schedule	word	R/W
7C59H~7C5BH	The 24 th holiday and schedule	word	R/W
7C5CH~7C5EH	The 25 th holiday and schedule	word	R/W
7C5FH~7C61H	The 26 th holiday and schedule	word	R/W
7C62H~7C64H	The 27 th holiday and schedule	word	R/W
7C65H~7C67H	The 28 th holiday and schedule	word	R/W
7C68H~7C6AH	The 29 th holiday and schedule	word	R/W
7C6BH~7C6DH	The 30 th holiday and schedule	word	R/W
7C6EH	The 4 th setting year	word	R/W
7C6FH	Holiday number of the 4th year	word	R/W
The 5th year Holiday address Function: 03H Read 10H Preset			
7C70H~7C72H	The 1 st holiday and schedule (format: month /day /schedule)	word	R/W
7C73H~7C75H	The 2 nd holiday and schedule	word	R/W
7C76H~7C78H	The 3 rd holiday and schedule	word	R/W
7C79H~7C7BH	The 4 th holiday and schedule	word	R/W
7C7CH~7C7EH	The 5 th holiday and schedule	word	R/W
7C7FH~7C81H	The 6 th holiday and schedule	word	R/W
7C82H~7C84H	The 7 th holiday and schedule	word	R/W
7C85H~7C87H	The 8 th holiday and schedule	word	R/W
7C88H~7C8AH	The 9 th holiday and schedule	word	R/W
7C8BH~7C8DH	The 10 th holiday and schedule	word	R/W
7C8EH~7C90H	The 11 th holiday and schedule	word	R/W
7C91H~7C93H	The 12 th holiday and schedule	word	R/W
7C94H~7C96H	The 13 th holiday and schedule	word	R/W

7C97H~7C99H	The 14 th holiday and schedule	word	R/W
7C9AH~7C9CH	The 15 th holiday and schedule	word	R/W
7C9DH~7C9FH	The 16 th holiday and schedule	word	R/W
7CA0H~7CA2H	The 17 th holiday and schedule	word	R/W
7CA3H~7CA5H	The 18 th holiday and schedule	word	R/W
7CA6H~7CA8H	The 19 th holiday and schedule	word	R/W
7CA9H~7CABH	The 20 th holiday and schedule	word	R/W
7CACH~7CAEH	The 21 st holiday and schedule	word	R/W
7CAFH~7CB1H	The 22 nd holiday and schedule	word	R/W
7CB2H~7CB4H	The 23 rd holiday and schedule	word	R/W
7CB5H~7CB7H	The 24 th holiday and schedule	word	R/W
7CB8H~7CBAH	The 25 th holiday and schedule	word	R/W
7CBBH~7CBDH	The 26 th holiday and schedule	word	R/W
7CBEH~7CC0H	The 27 th holiday and schedule	word	R/W
7CC1H~7CC3H	The 28 th holiday and schedule	word	R/W
7CC4H~7CC6H	The 29 th holiday and schedule	word	R/W
7CC7H~7CC9H	The 30 th holiday and schedule	word	R/W
7CAAH	The 5 th setting year	word	R/W
7CCBH	Holiday number of the 5th year	word	R/W
The 6th year Holiday address Function: 03H Read 10H Preset			
7CCCH~7CCEH	The 1 st holiday and schedule (format: month /day /schedule)	word	R/W
7CCFH~7CD1H	The 2 nd holiday and schedule	word	R/W
7CD2H~7CD4H	The 3 rd holiday and schedule	word	R/W
7CD5H~7CD7H	The 4 th holiday and schedule	word	R/W
7CD8H~7CDAH	The 5 th holiday and schedule	word	R/W
7CDBH~7CDDH	The 6 th holiday and schedule	word	R/W
7CDEH~7CE0H	The 7 th holiday and schedule	word	R/W
7CE1H~7CE3H	The 8 th holiday and schedule	word	R/W
7CD4H~7CE6H	The 9 th holiday and schedule	word	R/W
7CE7H~7CE9H	The 10 th holiday and schedule	word	R/W
7CEAH~7CECH	The 11 th holiday and schedule	word	R/W
7CEDH~7CEFH	The 12 th holiday and schedule	word	R/W
7CF0H~7CF2H	The 13 th holiday and schedule	word	R/W

7CF3H~7CF5H	The 14 th holiday and schedule	word	R/W
7CF6H~7CF8H	The 15 th holiday and schedule	word	R/W
7CF9H~7CFBH	The 16 th holiday and schedule	word	R/W
7CFCH~7CFEH	The 17 th holiday and schedule	word	R/W
7CFFH~7D01H	The 18 th holiday and schedule	word	R/W
7D02H~7D04H	The 19 th holiday and schedule	word	R/W
7D05H~7D07H	The 20 th holiday and schedule	word	R/W
7D08H~7D0AH	The 21 st holiday and schedule	word	R/W
7D0BH~7D0DH	The 22 nd holiday and schedule	word	R/W
7D0EH~7D10H	The 23 rd holiday and schedule	word	R/W
7D11H~7D13H	The 24 th holiday and schedule	word	R/W
7D14H~7D16H	The 25 th holiday and schedule	word	R/W
7D17H~7D19H	The 26 th holiday and schedule	word	R/W
7D1AH~7D1CH	The 27 th holiday and schedule	word	R/W
7D1DH~7D1FH	The 28 th holiday and schedule	word	R/W
7D20H~7D22H	The 29 th holiday and schedule	word	R/W
7D23H~7D25H	The 30 th holiday and schedule	word	R/W
7D26H	The 6 th setting year	word	R/W
7D27H	Holiday number of the 6 th year	word	R/W
The 7th year Holiday address Function: 03H Read 10H Preset			
7D28H~7D2AH	The 1 st holiday and schedule (format: month /day /schedule)	word	R/W
7D2BH~7D2DH	The 2 nd holiday and schedule	word	R/W
7D2EH~7D30H	The 3 rd holiday and schedule	word	R/W
7D31H~7D33H	The 4 th holiday and schedule	word	R/W
7D34H~7D36H	The 5 th holiday and schedule	word	R/W
7D37H~7D39H	The 6 th holiday and schedule	word	R/W
7D3AH~7D3CH	The 7 th holiday and schedule	word	R/W
7D3DH~7D3FH	The 8 th holiday and schedule	word	R/W
7D40H~7D42H	The 9 th holiday and schedule	word	R/W
7D43H~7D45H	The 10 th holiday and schedule	word	R/W
7D46H~7D48H	The 11 th holiday and schedule	word	R/W
7D49H~7D4BH	The 12 th holiday and schedule	word	R/W

7D4CH~7D4EH	The 13 th holiday and schedule	word	R/W
7D4FH~7D51H	The 14 th holiday and schedule	word	R/W
7D52H~7D54H	The 15 th holiday and schedule	word	R/W
7D55H~7D57H	The 16 th holiday and schedule	word	R/W
7D58H~7D5AH	The 17 th holiday and schedule	word	R/W
7D5BH~7D5DH	The 18 th holiday and schedule	word	R/W
7D5EH~7D60H	The 19 th holiday and schedule	word	R/W
7D61H~7D63H	The 20 th holiday and schedule	word	R/W
7D64H~7D66H	The 21 st holiday and schedule	word	R/W
7D67H~7D69H	The 22 nd holiday and schedule	word	R/W
7D6AH~7D6CH	The 23 rd holiday and schedule	word	R/W
7D6DH~7D6FH	The 24 th holiday and schedule	word	R/W
7D70H~7D72H	The 25 th holiday and schedule	word	R/W
7D73H~7D75H	The 26 th holiday and schedule	word	R/W
7D76H~7D78H	The 27 th holiday and schedule	word	R/W
7D79H~7D7BH	The 28 th holiday and schedule	word	R/W
7D7CH~7D7EH	The 29 th holiday and schedule	word	R/W
7D7FH~7D81H	The 30 th holiday and schedule	word	R/W
7D82H	The 7 th setting year	word	R/W
7D83H	Holiday number of the 7 th year	word	R/W
The 8th year Holiday address Function: 03H Read 10H Preset			
7D84H~7D86H	The 1 st holiday and schedule (format: month /day /time table)	word	R/W
7D87H~7D89H	The 2 nd holiday and schedule	word	R/W
7D8AH~7D8CH	The 3 rd holiday and schedule	word	R/W
7D8DH~7D8FH	The 4 th holiday and schedule	word	R/W
7D90H~7D92H	The 5 th holiday and schedule	word	R/W
7D93H~7D95H	The 6 th holiday and schedule	word	R/W
7D96H~7D98H	The 7 th holiday and schedule	word	R/W
7D99H~7D9BH	The 8 th holiday and schedule	word	R/W
7D9CH~7D9EH	The 9 th holiday and schedule	word	R/W
7D9FH~7DA1H	The 10 th holiday and schedule	word	R/W

7DA2H~7DA4H	The 11 th holiday and schedule	word	R/W
7DA5H~7DA7H	The 12 th holiday and schedule	word	R/W
7DA8H~7DAAH	The 13 th holiday and schedule	word	R/W
7DABH~7DADH	The 14 th holiday and schedule	word	R/W
7DAEH~7DB0H	The 15 th holiday and schedule	word	R/W
7DB1H~7DB3H	The 16 th holiday and schedule	word	R/W
7DB4H~7DB6H	The 17 th holiday and schedule	word	R/W
7DB7H~7DB9H	The 18 th holiday and schedule	word	R/W
7DBAH~7DBCH	The 19 th holiday and schedule	word	R/W
7DBDH~7DBFH	The 20 th holiday and schedule	word	R/W
7DC0H~7DC2H	The 21 st holiday and schedule	word	R/W
7DC3H~7DC5H	The 22 nd holiday and schedule	word	R/W
7DC6H~7DC8H	The 23 rd holiday and schedule	word	R/W
7DC9H~7DCBH	The 24 th holiday and schedule	word	R/W
7DCCH~7DCEH	The 25 th holiday and schedule	word	R/W
7DCFH~7DD1H	The 26 th holiday and schedule	word	R/W
7DD2H~7DD4H	The 27 th holiday and schedule	word	R/W
7DD5H~7DD7H	The 28 th holiday and schedule	word	R/W
7DD8H~7DDAH	The 29 th holiday and schedule	word	R/W
7DDBH~7DDDH	The 30 th holiday and schedule	word	R/W
7DDEH	The 8 th setting year	word	R/W
7DDFH	Holiday number of the 8 th year	word	R/W
The 9th year Holiday address Function: 03H Read 10H Preset			
7DE0H~7DE2H	The 1 st holiday and schedule (format: month /day /schedule)	word	R/W
7DE3H~7DE5H	The 2 nd holiday and schedule	word	R/W
7DE6H~7DE8H	The 3 rd holiday and schedule	word	R/W
7DE9H~7DEBH	The 4 th holiday and schedule	word	R/W
7DECH~7DEEH	The 5 th holiday and schedule	word	R/W
7DEFH~7DF1H	The 6 th holiday and schedule	word	R/W
7DF2H~7DF4H	The 7 th holiday and schedule	word	R/W
7DF5H~7DF7H	The 8 th holiday and schedule	word	R/W

7DF8H~7DFAH	The 9 th holiday and schedule	word	R/W
7DF8H~7DFDH	The 10 th holiday and schedule	word	R/W
7DFEH~7E00H	The 11 th holiday and schedule	word	R/W
7E01H~7E03H	The 12 th holiday and schedule	word	R/W
7E04H~7E06H	The 13 th holiday and schedule	word	R/W
7E07H~7E09H	The 14 th holiday and schedule	word	R/W
7E0AH~7E0CH	The 15 th holiday and schedule	word	R/W
7E0DH~7E0FH	The 16 th holiday and schedule	word	R/W
7E10H~7E12H	The 17 th holiday and schedule	word	R/W
7E13H~7E15H	The 18 th holiday and schedule	word	R/W
7E16H~7E18H	The 19 th holiday and schedule	word	R/W
7E19H~7E1BH	The 20 th holiday and schedule	word	R/W
7E1CH~7E1EH	The 21 st holiday and schedule	word	R/W
7E1FH~7E21H	The 22 nd holiday and schedule	word	R/W
7E22H~7E24H	The 23 rd holiday and schedule	word	R/W
7E25H~7E27H	The 24 th holiday and schedule	word	R/W
7E28H~7E2AH	The 25 th holiday and schedule	word	R/W
7E2BH~7E2DH	The 26 th holiday and schedule	word	R/W
7E2EH~7E30H	The 27 th holiday and schedule	word	R/W
7E31H~7E33H	The 28 th holiday and schedule	word	R/W
7E34H~7E36H	The 29 th holiday and schedule	word	R/W
7E37H~7E39H	The 30 th holiday and schedule	word	R/W
7E3AH	The 9 th setting year	word	R/W
7E3BH	Holiday number of the 9 th year	word	R/W
The 10th year Holiday address Function: 03H Read 10H Preset			
7E3CH~7E3EH	The 1 st holiday and schedule (format: month /day /schedule)	word	R/W
7E3FH~7E41H	The 2 nd holiday and schedule	word	R/W
7E42H~7E44H	The 3 rd holiday and schedule	word	R/W
7E45H~7E47H	The 4 th holiday and schedule	word	R/W
7E48H~7E4AH	The 5 th holiday and schedule	word	R/W
7E4BH~7E4DH	The 6 th holiday and schedule	word	R/W

7E4EH~7E50H	The 7 th holiday and schedule	word	R/W
7E51H~7E53H	The 8 th holiday and schedule	word	R/W
7E54H~7E56H	The 9 th holiday and schedule	word	R/W
7E57H~7E59H	The 10 th holiday and schedule	word	R/W
7E5AH~7E5CH	The 11 th holiday and schedule	word	R/W
7E5DH~7E5FH	The 12 th holiday and schedule	word	R/W
7E60H~7E62H	The 13 th holiday and schedule	word	R/W
7E63H~7E65H	The 14 th holiday and schedule	word	R/W
7E66H~7E68H	The 15 th holiday and schedule	word	R/W
7E69H~7E6BH	The 16 th holiday and schedule	word	R/W
7E6CH~7E6EH	The 17 th holiday and schedule	word	R/W
7E6FH~7E71H	The 18 th holiday and schedule	word	R/W
7E72H~7E74H	The 19 th holiday and schedule	word	R/W
7E75H~7E77H	The 20 th holiday and schedule	word	R/W
7E78H~7E7AH	The 21 st holiday and schedule	word	R/W
7E7BH~7E7DH	The 22 nd holiday and schedule	word	R/W
7E7EH~7E80H	The 23 rd holiday and schedule	word	R/W
7E81H~7E83H	The 24 th holiday and schedule	word	R/W
7E84H~7E86H	The 25 th holiday and schedule	word	R/W
7E87H~7E89H	The 26 th holiday and schedule	word	R/W
7E8AH~7E8CH	The 27 th holiday and schedule	word	R/W
7E8DH~7E8FH	The 28 th holiday and schedule	word	R/W
7E90H~7E92H	The 29 th holiday and schedule	word	R/W
7E93H~7E95H	The 30 th holiday and schedule	word	R/W
7E96H	The 10 th setting year	word	R/W
7E97H	Holiday number of the 10 th year	word	R/W

Table 6-55

Address	Parameter	Data Type	Property	Range	Default	Factory Setting
8000H	Manual Triggering Waveform	word	R/W	0XAA:Enable; 0:Disable	0	0
8001H	DI Triggering — AXM-11	word	R/W	bit1bit0: DI1; bit3bit2: DI2; bit5bit4: DI3; bit7bit6: DI4; bit9bit8: DI5; bit11bit10: DI6; 00: Disable; 01: From OFF to ON; 10: From ON to OFF; 11: Any DI state change;	0	0
8002H	DI Triggering — AXM-21	word	R/W	Bit1bit0: DI7; bit3bit2 : DI8; bit5bit4: DI9; bit7bit6: DI10; The same as above	0	0
8003H	DI Triggering — AXM-31	word	R/W	Bit1bit0: DI11; bit3bit2 : DI12; bit5bit4: DI13; bit7bit6: DI14; The same as above	0	0
8004H	Voltage Rated Value	word	R/W	50V – 400V or 50V – 690V (only in 3LL)	400	400
8005H	Voltage Sag Triggering Waveform	word	R/W	1: Enable; 0: Disable	0	0
8006H	Voltage Sag Threshold	word	R/W	20---100(%)	50	50
8007H	Voltage Sag half cycle count	word	R/W	4-200 half cycles	10	10

Address	Parameter	Data Type	Property	Range	Default	Factory Setting
8008H	Voltage Swell Triggering Waveform	word	R/W	1: Enable; 0: Disable	0	0
8009H	Voltage Swell Threshold	word	R/W	50—140(%)	100	100
800AH	Reserved	word	R/W			
800BH	Current Rated Value	word	R/W	500—5000(mA)	5000	5000
800CH	Over-current Triggering Waveform	word	R/W	1: Enable; 0: Disable	0	0
800DH	Over-current	word	R/W	50—150(%)	100	100
	Threshold					
800EH	Clear Waveform	word	R/W	0X55 enable	0	0
800FH	Clear Power Quality Event	word	R/W	0X55 enable	0	0

Note: In 3LL and 2LL ,voltage rated value is line voltage; in 3LN, 1LN and 1LL, voltage rated value is phase voltage.

Waveform Capture Data Retrieve Address

Waveform Capture includes timestamp, triggering condition, and waveform data. Every group uses the same data format. Only one group of waveform is saved in the registers. When retrieving the waveform, firstly write 1-8 group number into 0X801FH, then read the registers after it to acquire waveform corresponding to the written group number.

The relationship between voltage waveform value and real value:

$$\text{Real Value (Unit: V)} = \text{Waveform Value} / 37.59105$$

The relationship between current waveform value and real value:

1)5A, 1A: Real Value(Unit: A) = Waveform Value/1683.153;

2)333mV: Real Value(Unit: A) = Waveform Value/K (firmware above 3.21,K=14427.15; other: K = 15869.87);

3)100mV(Rope-CT):Real Value(Unit: A) = Waveform Value/K (firmware above 3.21,K=20291.1; firmware 3.20, K=22068.8,other: K = 15869.87);

4)mA CT:Real Value(Unit:A) = Waveform Value/K (80mA CT:K=7414.289; 100mA:K=9267.440; 200mA:K=18514.68);

The voltage and current value obtained from the waveform are the PT or CT secondary side value.

Read: 03, Preset: 10. For more information, please refer to Chapter 4.7.

Table 6-56

Address	Parameter	Default	Range	Data type	Property
8E00H	Waveform Group Number for Retrieving		1~100 Note: When the value is smaller than or equal to newest waveform record group number, this value is valid	Word	R/W
8E01H	Waveform group number		Waveform number 0-121	Word	R/W
8E02H	Waveform record window status		0x0BH: window data is valid. 0xFF: window data is invalid. 0xAA: waveform record memory is clearing(data is invalid)	Word	R
8E03H	Newest Waveform Group Number		1~100 0: no record	Word	R
8E04H~ 8E43	Waveform record data retrieving window		-32768~ 32767	Word	R

Power Quality Event Retrieve Address

Power quality event includes timestamp, triggering condition and related settings. Every group uses the same data format. Only 10 groups of data are saved in the registers. When retrieving the event data, its parameters must be correctly set in order to get correct information.

Read: FC03, Preset: FC16. For more information, please refer to Chapter 4.7.

Table 6-57

Address	Parameter	Data Type	Property	Range	Default	Factory Settings
8CFDH	Newest Event Group Number	word	R	1—50000 0: No Data	0	0
8CFEH	Event for Retrieving starting group number	word	R/W	1-50000 Note: only valid smaller or equal to Newest Event Group Number	1	1
8CFFH						
No.1 Event						
8D00H	Timestamp High Byte – Year Low Byte - Month	word	R	Time		
8D01H	Timestamp High Byte –Day Low Byte –Hour	word	R	Time		
8D02H	Timestamp High Byte – Minute Low Byte - Second	word	R	Time		
8D03H	Timestamp: Millisecond	word	R	Time		

Address	Parameter	Data Type	Property	Range	Default	Factory Settings
8D04H	Voltage Sag or Voltage Swell condition	word	R	0: disabled 1: Voltage Sag 2: Voltage Swell		
8D05H	Rated Value	word	R	50V ~ 400V or 50V ~ 690V (only in 3LL)		
8D06H	Threshold	word	R	Voltage Sag: 20- 100 (%) Voltage Swell: 50- 140 (%)		
8D07H	Half-Cycle Count	word	R	Voltage Sag Event: 4~200; Voltage Swell Event: 0		
8D08H~ 8D0FH	No. 2 Event	word	R			
8D10H~ 8D17H	No. 3 Event	word	R			
8D18H~ 8D1FH	No. 4 Event	word	R			
8D20H~ 8D27H	No. 5 Event	word	R			
8D28H~ 8D2FH	No. 6 Event	word	R			

6.4 DNP3.0 Protocol Introduction

Structure Model

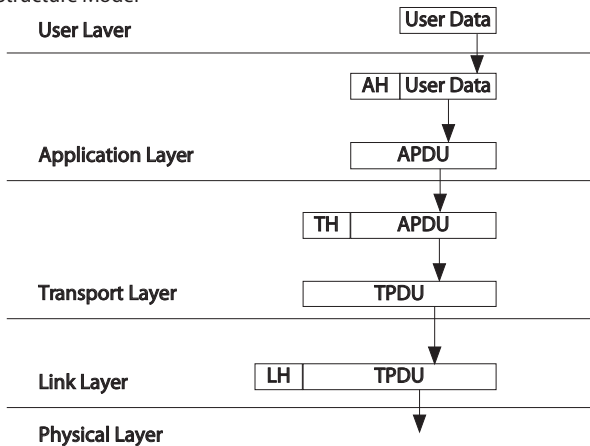

Figure 6-2 Each Layer of the relationship between the data unit

6.4.1 Overview

This document describes the DNP3.0 communications protocol employed by Acuvim II Series Power Meter. This protocol can be selected for the serial communication port which can consist of RS232/RS485. It is assumed that the reader is familiar with the DNP3.0 protocol and serial communications in general. This DNP3.0 is a reduced set of the Distributed Network Protocol Version 3.00, and it gives enough functionality to get critical measurement from the Acuvim II Series Power Meter. The DNP3.0 supports class0 object only. No event generation is supported. This DNP3.0 is always act as a slave device.

6.4.2 Physical Layer

The physical layer supported by DNP3.0 must transmit or receive data in serial mode. The data unit transferred will be 8 bits in length.

The port must be asynchronous half-duplex RS-485.

The data format supporting 8 bit data, 1 start bit, 1 stop bit, no parity.

The baud rate can be set to any supported value.

6.4.3 Data Link Layer

The Acuvim II Series Power Meter always acts as a Slave device .The device address can be set from 0 to 65534. The link layer comply with the stand FT3 frame format. The fixed length user data field is behind the fixed head. The link layer supports Reset Link, Reset User and Read Link Status. In order to ensure the stability of communication, it is recommended that you should better reset the link and reset the user before communicate with the Acuvim II Series Power Meter.

The function code supported as follows:

Reset Link (0X00), Reset User (0X01), Link Status (0X09).

FT3 Frame Format:

An FT3 frame is defined as a fixed length header block followed by optional data blocks. Each block has a 16-bit CRC appended to it. The header fields consist of 2 start octets, 1 octet length, 1 octet control, a destination address, a source address and a 16-bit CRC appended to it.

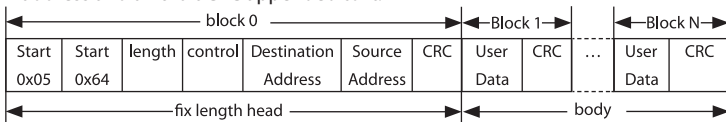

6.4.4 Transport Layer

The pseudo-transport layer segments application layer messages into multiple data link frames. For each frame, it inserts a single byte function code that indicates if the data link frame is the first frame of the message, the last frame of a message, or both (for single frame messages). The function code also includes a rolling frame sequence number which increments with each frame and allows the receiving transport layer to detect dropped frames.

6.4.5 Application Layer

The Acuvim II Series Power Meter implementation supports a subset of the objects and application layer function codes. The Acuvim II Series Power Meter will neither accept nor send multiple fragment application layer messages. The Acuvim II Series Power Meter's fragment size is fixed at 2k bytes.

Each application layer fragment begins with an application layer header followed by one object header or object header and data combinations. The application layer header contains an application control code and an application function code. The application control code contains an indication if the fragment is one of a multi-fragment message, contains an indication if an application layer confirmation is requested for the fragment, contains an indication if the fragment was unsolicited, and contains a rolling application layer sequence number. The application layer sequence number allows the receiving application layer to detect fragments that are out of sequence, or dropped fragments.

In the Acuvim II Series Power Meter, the DNP3.0 supports the Read function , the Direct Operate function and the Direct Operate Unconfirmed function.

The Read function (0X01)

The read function is the basic code used for requesting data objects from an Outstation. Here this function is used for reading the measurement data from

the Power Meter. Learning more about the measurement data, please refer to the Data Address Table. In this function, the qualifier could be selected contain 0X00, 0X01, 0X06.

The qualifier 0X00 refers that there two bytes called Range followed by, one is the start address want to request, the second is the stop address, this Range would be from 0 to 255.

The qualifier 0X01 indicates that the followed Range there are four bytes, the first two is the Start Address want to be request, the last two is the Stop Address, the two bytes consist of two 8-bit binary number , the low byte first, that the address Range would be from 0 to 65535.

The qualifier 0X06 means read All data from the object with its respective variations which would be list in the queue.

More about the message please see Message Layout, the detailed examples.

The Direct Operate function (0X05)

The function is selects and sets or operates the specified outputs, the status of the control points will be responded. Here this function is intended for resetting the energy counters and the demand counters. These actions are mapped to Objects 12 Variations 1, point 1 and point 2, there are seen as a control relay. The relay must be operated On in 0 millisecond , and released Off in 1 millisecond .The qualifiers 0X17 and 0X28 are supported for writing the energy reset and demand reset. The examples will be shown in Message Layout.

The Direct Operate function (0X06)

The function is selects and sets or operates the specified outputs but do not send a response to the request. Here this function is intended for switching the DNP3.0 protocol to Modbus protocol using the same communication port. This switching is seen as a control relay mapped into Object 12 Variation 1 and point

0 in the Acuim Iseries Power Meter. The relay must be operated with qualifier 0X17, code 3, count 0, with 0 millisecond On and 1 millisecond Off. After sending the request the current communication port will be changed to the Modbus protocol only. The example will be shown in the Message Layout.

6.4.6 Error Reply

When meet the can't recognize request , the unknown Object ,the unknown variation ,the point unsupported , the unsupported function code , the unsupported qualifier ,the unsupported range , the buffer overflow or any other exception error , an error reply will be generate from the Acuim II series Power Meter to send to the requester station . The Internal Indicator field will reflect the type of error.

6.4.7 Profile

1) Device Function

Slave

2) Maximum Data Link Frame Size

Transmitted 292

Received 292

3) Maximum Application Fragment Size

Transmitted 2048

Received 2048

4) Transport Multi-Fragment

Supported

- 5) Data Link Layer Confirmation
 - Supported
- 6) Application Layer Confirmation
 - Supported
- 7) Application Layer Function
 - Request
 - Supported 0X01, Read
 - Qualifier, 0X00, 0X01, 0X06.
 - Response
 - Supported 129, Read Response
 - Qualifier, 0X00
 - Supported Error Internal Indicator Response
- 8) DATA OBJECT LIBRARY
 - a) ANALOG INPUT OBJECT 30
 - Variation: 3, 32-BIT ANALOG INPUT WITHOUT FLAG
 - Variation: 4, 16-BIT ANALOG INPUT WITHOUT FLAG
 - Variation 5, 32-BIT FLOAT WITH FLAG
 - b) COUNTER OBJECT DEFINITIONS 20
 - Variation: 5, 32-BIT COUNTER WITHOUT FLAG
 - c) ALTERNATE NUMERIC OBJECT 100

Variation: 1 SHORT FLOATING POINT

d) CONTROL RELAY OUTPUT BLOCK Object 12

Variation: 01, static digital output control

6.4.8 Data Address Table

Point Descriptions

The following tables describe the DNP3.0 data objects provided by the Acuvim II series Power Meter. The object, variation, and point numbers are specified for each parameter, as well as the application layer function codes which may be used to operate on the parameter.

Description:

Table 6-58

Object		Variation	32-BIT ANALOG INPUT WITHOUT FLAG
30		3	
Object		Variation	16-BIT ANALOG INPUT WITHOUT FLAG
30		4	
Object		Variation	32-BIT FLOAT INPUT WITH FLAG
30		5	
Object		Variation	32-BIT FLOAT INPUT WITH FLAG
100		1	
Object		Variation	32-BIT COUNTER WITHOUT FLAG
20		5	
Object		Variation	CONTROL RELAY OUTPUT BLOCK
12		1	

Address Table:

Table 6-59

Object	Point	Variation	Name	Format	Range	Multiplier	Units	Descriptor
100	0	1	Freq_rms	Float		1.0	Hz	Frequency
100	1	1	Ua_rms	Float		1.0	V	Voltage A
100	2	1	Ub_rms	Float		1.0	V	Voltage B
100	3	1	Uc_rms	Float		1.0	V	Voltage C
100	4	1	Uvag_rms	Float		1.0	V	Phrase Voltage Avg
100	5	1	Uab_rms	Float		1.0	V	Voltage A-B
100	6	1	Ubc_rms	Float		1.0	V	Voltage B-C
100	7	1	Uca_rms	Float		1.0	V	Voltage C-A
100	8	1	Ulag_rms	Float		1.0	A	Line Voltage Avg
100	9	1	la_rms	Float		1.0	A	Current A
100	10	1	lb_rms	Float		1.0	A	Current B
100	11	1	lc_rms	Float		1.0	A	Current C
100	12	1	lvag_rms	Float		1.0	A	Current Average
100	13	1	ln_rms	Float		1.0	A	Neutral Current
100	14	1	Pa_rms	Float		1.0	W	Pa
100	15	1	Pb_rms	Float		1.0	W	Pb
100	16	1	Pc_rms	Float		1.0	W	Pc
100	17	1	P_rms	Float		1.0	W	Total Active Power
100	18	1	Qa_rms	Float		1.0	var	Qa
100	19	1	Qb_rms	Float		1.0	var	Qb
100	20	1	Qc_rms	Float		1.0	var	Qc
100	21	1	Q_rms	Float		1.0	var	Total Reactive Power
100	22	1	Sa_rms	Float		1.0	VA	Sa
100	23	1	Sb_rms	Float		1.0	VA	Sb
100	24	1	Sc_rms	Float		1.0	VA	Sc
100	25	1	S_rms	Float		1.0	VA	Total Apparent Power
100	26	1	PFa_rms	Float		1.0	None	PFa
100	27	1	PFb_rms	Float		1.0	None	PFb

Object	Point	Variation	Name	Format	Range	Multiplier	Units	Descriptor
100	28	1	Pfc_rms	Float		1.0	None	Pfc
100	29	1	PF_rms	Float		1.0	None	Total Power Factor
100	30	1	Unbl_u2	Float		1.0	None	Voltage Imbalance
100	31	1	Unbl_i2	Float		1.0	None	Current Imbalance
100	32	1	Rlc_val	Float		1.0	None	Load Characteristics
100	33	1	P_dema	Float		1.0	W	P Demand
100	34	1	Q_dema	Float		1.0	var	Q Demand
100	35	1	S_dema	Float		1.0	VA	S Demand
100	36	1	la_Demand	Float		1.0	A	la Demand
100	37	1	lb_Demand	Float		1.0	A	lb Demand
100	38	1	lc_Demand	Float		1.0	A	lc Demand

Table 6-60

Object	Point	Variation	Name	Format	Range	Multiplier	Units	Descriptor
20	0	5	Active_Energy_IMP	UINT32	0~999999999	0.1/0.001	W/hr	Active_Energy_IMP
20	1	5	Active_Energy_EXP	UINT32	0~999999999	0.1/0.001	W/hr	Active_Energy_EXP
20	2	5	Reactive_Energy_IMP	UINT32	0~999999999	0.1/0.001	var/hr	Reactive_Energy_IMP
20	3	5	Reactive_Energy_EXP	UINT32	0~999999999	0.1/0.001	var/hr	Reactive_Energy_EXP
20	4	5	Active_Energy_TOTAL	UINT32	0~999999999	0.1/0.001	W/hr	Active_Energy_TOTAL
20	5	5	Active_Energy_NET	UINT32	0~999999999	0.1/0.001	W/hr	Active_Energy_NET
20	6	5	Reactive_Energy_TOTAL	UINT32	0~999999999	0.1/0.001	var/hr	Reactive_Energy_TOTAL

Object	Point	Variation	Name	Format	Range	Multiplier	Units	Descriptor
20	7	5	Reactive_ Energy_NET	UINT32	0~999999999	0.1/0.001	var/hr	Reactive_ Energy_NET
20	8	5	Apprent_ Energy	UINT32	0~999999999	0.1/0.001	VA/hr	Apprent_Energy
20	9	5	DI1Counts	UINT32	0~4294967259	1	None	DI1Counts
20	10	5	DI2Counts	UINT32	0~4294967259	1	None	DI2Counts
20	11	5	DI3Counts	UINT32	0~4294967259	1	None	DI3Counts
20	12	5	DI4Counts	UINT32	0~4294967259	1	None	DI4Counts
20	13	5	DI5Counts	UINT32	0~4294967259	1	None	DI5Counts
20	14	5	DI6Counts	UINT32	0~4294967259	1	None	DI6Counts
20	15	5	DI7Counts	UINT32	0~4294967259	1	None	DI7Counts
20	16	5	DI8Counts	UINT32	0~4294967259	1	None	DI8Counts
20	17	5	DI9Counts	UINT32	0~4294967259	1	None	DI9Counts
20	18	5	DI10Counts	UINT32	0~4294967259	1	None	DI10Counts
20	19	5	DI11Counts	UINT32	0~4294967259	1	None	DI11Counts
20	20	5	DI12Counts	UINT32	0~4294967259	1	None	DI12Counts
20	21	5	DI13Counts	UINT32	0~4294967259	1	None	DI13Counts
20	22	5	DI14Counts	UINT32	0~4294967259	1	None	DI14Counts
20	23	5	DI15Counts	UINT32	0~4294967259	1	None	DI15Counts
20	24	5	DI16Counts	UINT32	0~4294967259	1	None	DI16Counts
20	25	5	DI17Counts	UINT32	0~4294967259	1	None	DI17Counts
20	26	5	DI18Counts	UINT32	0~4294967259	1	None	DI18Counts
20	27	5	DI19Counts	UINT32	0~4294967259	1	None	DI19Counts
20	28	5	DI20Counts	UINT32	0~4294967259	1	None	DI20Counts
20	29	5	DI21Counts	UINT32	0~4294967259	1	None	DI21Counts
20	30	5	DI22Counts	UINT32	0~4294967259	1	None	DI22Counts
20	31	5	DI23Counts	UINT32	0~4294967259	1	None	DI23Counts
20	32	5	DI24Counts	UINT32	0~4294967259	1	None	DI24Counts
20	33	5	DI25Counts	UINT32	0~4294967259	1	None	DI25Counts
20	34	5	DI26Counts	UINT32	0~4294967259	1	None	DI26Counts
20	35	5	DI27Counts	UINT32	0~4294967259	1	None	DI27Counts
20	36	5	DI28Counts	UINT32	0~4294967259	1	None	DI28Counts

Table 6-61

Object	Point	Variation	Name	Format	Range	Multiplier	Units	Descriptor
30	0	4	THD_V1	UINT16	0~10000	0.01	None	THD_V1
30	1	4	THD_V2	UINT16	0~10000	0.01	None	THD_V2
30	2	4	THD_V3	UINT16	0~10000	0.01	None	THD_V3
30	3	4	THD_V	UINT16	0~10000	0.01	None	THD_V
30	4	4	THD_I1	UINT16	0~10000	0.01	None	THD_I1
30	5	4	THD_I2	UINT16	0~10000	0.01	None	THD_I2
30	6	4	THD_I3	UINT16	0~10000	0.01	None	THD_I3
30	7	4	THD_I	UINT16	0~10000	0.01	None	THD_I

Table 6-62

Object	Point	Variation	Name	Format	Range	Multiplier	Units	Descriptor
12	0	1	DNP_ MODBUS	None	1	1	None	Responds to Function 6 (Direct Operate-No Ack) , Qualifier Code 17x, Control Code 3, Count 0, On 0 msec, Off 1 msec ONLY
12	1	1	Reset_ Energy_ Counters	None	1	1	None	Responds to Function 5 (Direct Operate) Qualifier Code 17x or 28x, Control Code 3, Count 0, On 0 msec, Off 1 msec ONLY
12	2	1	Reset_ Demand_ Counters	None	1	1	None	Responds to Function 5 (Direct Operate) Qualifier Code 17x or 28x, Control Code 3, Count 0, On 0 msec, Off 1 msec ONLY

6.4.9 DNP3.0 Message Layout

The following table is the abbreviation and explain.

Table 6-63

DestL	The destination address low byte
DestH	The destination address high byte
SorL	The source address low byte
SorH	The source address high byte
CrcL	The Cyclic Redundancy Checksum low byte
CrcH	The Cyclic Redundancy Checksum high byte
x	The transport layer data sequence num
y	The application layer data sequence num
II1	The first byte of Internal Indicator
II2	The second byte of Internal Indicator

Link Layer Frames:

Table 6-64

Reset Link:

Request	05	64	05	C0	DestL	DestH	SorL	SorH	CrcL	CrcH
Response	05	64	05	00	SorL	SorH	DestL	DestH	CrcL	CrcH

Reset User:

Request	05	64	05	C1	DestL	DestH	SorL	SorH	CrcL	CrcH
Response	05	64	05	00	SorL	SorH	DestL	DestH	CrcL	CrcH

Link Status:

Request	05	64	05	C9	DestL	DestH	SorL	SorH	CrcL	CrcH
Response	05	64	05	00	SorL	SorH	DestL	DestH	CrcL	CrcH

Application Layer Frames:

Reset Energy:

Table 6-65

	01	02	03	04	05	06	07	08	09
Reset Energy									
Request	05	64	18	C4	DestL	DestH	SorL	SorH	CrcL
	Cx	Cy	05	0C	01	17	01	01	03
	00	00	00	CrcL	CrcH				
Response	05	64	1A	44	SorL	SorH	DestL	DestH	CrcL
	Cx	Cy	81	111	112	0C	01	17	01
	01	00	00	00	00	CrcL	CrcH		
Request	05	64	1A	C4	DestL	DestH	SorL	SorH	CrcL
	Cx	Cy	05	0C	01	28	01	00	01
	01	00	00	00	00	CrcL	CrcH		
Response	05	64	1C	44	SorL	SorH	DestL	DestH	CrcL
	Cx	Cy	81	111	112	0C	01	28	01
	00	00	01	00	00	00	00	CrcL	CrcH
	10	11	12	13	14	15	16	17	18
Reset Energy									
Request	CrcH								
	00	00	00	00	00	01	00	CrcL	CrcH
Response	CrcH								
	01	03	00	00	00	00	00	CrcL	CrcH
Request	CrcH								
	00	03	00	00	00	00	00	CrcL	CrcH
Response	CrcH								
	00	01	00	03	00	00	00	CrcL	CrcH

Table 6-66

	01	02	03	04	05	06	07	08	09
Reset Energy									
Request	05	64	18	C4	DestL	DestH	SorCL	SorCH	CrCL
	Cx	Cy	05	0C	01	17	01	01	03
	00	00	00	CrCL	CrCH				
Response	05	64	1A	44	SorCL	SorCH	DestL	DestH	CrCL
	Cx	Cy	81	111	112	0C	01	17	01
	01	00	00	00	00	CrCL	CrCH		
Request	05	64	1A	C4	DestL	DestH	SorCL	SorCH	CrCL
	Cx	Cy	05	0C	01	28	01	00	02
	01	00	00	00	00	CrCL	CrCH		
Response	05	64	1C	44	SorCL	SorCH	DestL	DestH	CrCL
	Cx	Cy	81	111	112	0C	01	28	01
	00	00	01	00	00	00	00	CrCL	CrCH
	10	11	12	13	14	15	16	17	18
Reset Energy									
Request	CrCH								
	00	00	00	00	00	01	00	CrCL	CrCH
Response	CrCH								
	02	03	00	00	00	00	00	CrCL	CrCH
Request	CrCH								
	00	03	00	00	00	00	00	CrCL	CrCH
Response	CrCH								
	00	02	00	03	00	00	00	CrCL	CrCH

Switch to Modbus:

Table 6-67

	01	02	03	04	05	06	07	08	09
Request	05	64	18	C4	DestL	DestH	SorcL	SorcH	CrcL
	Cx	Cy	06	0C	01	17	01	00	03
	00	00	00	CrcL	CrcH				
	10	11	12	13	14	15	16	17	18
Request	CrcH								
00	00	00	00	00	00	01	00	CrcL	CrcH

Request Data:

Qualifier 0X06:

Table 6-68

	01	02	03	04	05	06	07	08	09
Reset Energy	0x06								
Request	05	64	0B	C4	DestL	DestH	SorcL	SorcH	CrcL
	Cx	Cy	01	1E	04	06	CrcL	CrcH	
Response	05	64	1F	44	SorcL	SorcH	DestL	DestH	CrcL
	Cx	Cy	81	111	112	1E	04	00	00
	Data3	Data3	Data4	Data4	Data5	Data5	Data6	Data6	Data7
	L	H	L	H	L	H	L	H	L
	10	11	12	13	14	15	16	17	18
Reset Energy									
Request	CrcH								
Response	CrcH								
	07	Data0	Data0	Data1	Data1	Data2	Data2	CrcL	CrcH
		L	H	L	H	L	H		
	Data7	CrcL	CrcH						
	H								

Qualifier OX00:

Table 6-69

	01	02	03	04	05	06	07	08	09
Reset Energy	0x00								
Request	05	64	0D	C4	DestL	DestH	SorCL	SorCH	CrCL
	Cx	Cy	01	64	01	00	03	07	CrCL
Response	05	64	1F	44	SorCL	SorCH	DestL	DestH	CrCL
	Cx	Cy	81	111	112	64	01	00	03
	Data4	Data4	Data4	Data4	Flag 5	Data5	Data5	Data5	Data5
	1	2	3	4		1	2	3	4
	Data7	Data7	Data7	CrCL	CrCH				
	2	3	4						
	10	11	12	13	14	15	16	17	18
Reset Energy									
Request	CrCH								
	CrCH								
Response	CrCH								
	07	Flag 3	Data3	Data3	Data3	Data3	Flag 4	CrCL	CrCH
			1	2	3	4			
	Flag 6	Data6	Data6	Data6	Data6	Flag 7	Data7	CrCL	CrCH
		1	2	3	4		1		

Qualifier OX00:

Table 6-70

	01	02	03	04	05	06	07	08	09
Reset Energy	0x00								
Request	05	64	0D	C4	DestL	DestH	SorCL	SorCH	CrCL
	Cx	Cy	01	14	05	00	03	07	CrCL
Response	05	64	28	44	SorCL	SorCH	DestL	DestH	CrCL
	Cx	Cy	81	111	112	14	05	00	03
	Data6	Data6	Data7	Data7	CrCL	CrCH			
	L	H	L	H					

	10	11	12	13	14	15	16	17	18
Reset Energy									
Request	CrcH								
	CrcH								
Response	CrcH								
	07	Data3 L	Data3 H	Data4 L	Data4 H	Data5 L	Data5 H	CrcL	CrcH

Qualifier OX01:

Table 6-71

	01	02	03	04	05	06	07	08	09
Reset Energy	0x01								
Request	05	64	0F	C4	DestL	DestH	SorcL	SorcH	CrcL
	Cx	Cy	01	14	05	01	00	00	0A
Response	05	64	3D	44	SorcL	SorcH	DestL	DestH	CrcL
	Cx	Cy	81	111	112	14	05	01	00
	Data2 L	Data2 H	Data3 L	Data3 H	Data4 L	Data4 H	Data5 L	Data5 H	Data6 L
	Data10 L	Data10 H	CrcL	CrcH					
	10	11	12	13	14	15	16	17	18
Reset Energy									
Request	CrcH								
	00	CrcL	CrcH						
Response	CrcH								
	00	0A	00	Data0 L	Data0 H	Data1 L	Data1 H	CrcL	CrcH
	Data6 H	Data7 L	Data7 H	Data8 L	Data8 H	Data9 L	Data9 H	CrcL	CrcH

Error Reply:

Error Reply										
Response	05	64	0A	44	DestL	DestH	SorcL	SorcH	CrcL	CrcH
	Cx	Cy	81	111	112	CrcL	CrcH			

Appendix

Appendix A Technical Data and Specifications

Appendix B Ordering Information

Appendix C Revision History

Appendix A Technical Data and Specification

Input ratings

Energy Accuracy (Acuvim IIR)	
Active power (according to IEC 62053-22) (according to ANSI C12.20)	Class 0.2S Class 0.2
Reactive (according to IEC 62053-23)	Class 2
Harmonic Resolution	
Metered Value	2 nd ~ 63 rd (50Hz or 60Hz type) 2 nd ~ 15 th (400Hz type)

Voltage input	
Nominal Full Scale	400Vac L-N, 690Vac L-L
Withstand	1500Vac continuous 3250Vac, 50/60Hz for 1 minute
Input Impedance	2Mohm per phase
Metering Frequency	45Hz~65Hz
Pickup Voltage	10Vac
Accuracy	0.2% full scale

Current Inputs (Each Channel)	
Nominal Current	① 5A, ② 1A, ③ 1A(333mV), ④ 1A(100mV Rope-CT), ⑤ 1A(80mA/100mA/200mA)
Metering Range	① 0~10A, ② 0~2A, ③ 0~1.2A, ④ 0~1.2A, ⑤ 0~1.2A
Pickup Current	① 5mA, ② 1mA, ③ 5mA, ④ 5mA, ⑤ 5mA
Withstand	20Arms continuous, 100Arms for 1 second, non-recurring
Burden	0.05VA (typical) @ 5Arms
Accuracy	0.2% full scale

Accuracy

Parameters		Accuracy	Resolution	Range
Voltage		0.2%	0.1V	10V~1000kV
Current		0.2%	0.001A	5mA~50000A
Power		0.2%	1W	-9999MW~9999MW
Reactive Power		0.2%	1Var	-9999MVar~9999MVar
Apparent Power		0.2%	1VA	0~9999MVA
Power Demand		0.2%	1W	-9999MW~9999MW
Reactive Power Demand		0.2%	1Var	-9999MVar~9999MVar
Apparent Power Demand		0.2%	1VA	0~9999MVA
Power Factor		0.2%	0.001	-1.000~1.000
Frequency		0.2%	0.01Hz	45.00~65.00Hz (50Hz or 60Hz type) 300.00~500.00 (400 type)
Energy	Primary	0.2%	0.1kWh	0~9999999.9kWh
	Secondary	0.2%	0.001kWh	0~999999.999kWh
Reactive Energy	Primary	0.2%	0.1kvarh	0~9999999.9kvarh
	Secondary	0.2%	0.001kvarh	0~999999.999kvarh
Apparent Energy	Primary	0.2%	0.1kVAh	0~9999999.9kVAh
	Secondary	0.2%	0.001kVAh	0~999999.999kVAh
Harmonics		1.0%	0.1%	≥0.0%
Phase Angle		2.0%	0.1°	0.0°~359.9°
Imbalance Factor		2.0%	0.1%	0.0% ~ 100%
Running Time		<1second/day	0.01h	0~9999999.99h
Temperature Drift		<100ppm/°C		
		0.5%/year		

Control power

AC/DC Control Power	
Operating Range	100~415Vac, 50/60Hz; 100~300Vdc
Burden	5W
Withstand	3250Vac, 50/60Hz 1min
	Installation Category III (Distribution)
Low Voltage DC Control Power (Optional)	
Operating Range	20~60Vdc
Burden	5W

I/O Option

Digital Input	
Input Voltage Range	20~160Vac/dc
Input Current (Max)	2mA
Start Voltage	15V
Stop Voltage	5V
Pulse Frequency (Max)	100Hz, 50% Duty Ratio
SOE Resolution	2ms
Digital Output (DO) (Photo-MOS)	
Voltage Range	0~250Vac/dc
Load Current	100mA(Max)
Output Frequency	25Hz, 50% Duty Ratio
Isolation Voltage	2500Vac
Relay Output (RO)	
Switching Voltage (Max)	250Vac,30Vdc
Load Current	5A(R), 2A(L)
Set Time	10ms (Max)
Contact Resistance	30mΩ(Max)
Isolation Voltage	2500Vac
Mechanical Life	1.5×10^7
Analog Output (AO)	
Output Range	0~5V/1~5V, 0~20mA/4~20mA(Optional)
Accuracy	0.5%
Temperature Drift	50ppm/°C typical
Isolation Voltage	500Vdc
Open Circuit Voltage	15V
Analog Input (AI)	
Input Range	0~5V/1~5V, 0~20mA/4~20mA (Optional)
Accuracy	0.2%
Temperature Drift	50ppm/°C typical
Isolation Voltage	500Vdc
Power Supply for DI (24Vdc)	
Output Voltage	24Vdc
Output Current	42mA
Load (Max)	21DIs

Suitable Conditions	
Dimensions (mm)	96x96x51 (Cut-out 92x92 or 4-inch Round)
Protection Level	IP54 (Front), IP30 (Cover)
Weight (g)	350g
Temperature	-25°C~70°C, Metering -40°C~85°C, Storage
Humidity	5%~95% Non-condensing
Power Supply	100~415Vac, 50/60Hz; 100~300Vdc Category III, Pollution degree 2
Power Consumption	5W

Standard Compliance	
Measurement Standard	IEC 62053-22; ANSI C12.20
Environmental Standard	IEC 60068-2
Safety Standard	IEC 61010-1, UL 61010-1
EMC Standard	IEC 61000-4/-2-3-4-5-6-8-11, CISPR 22
Outlines Standard	DIN 43700, ANSI C39.1

Communication	
RS-485 (Standard)	2-wire connection
	MODBUS RTU Protocol or DNP3.0 Protocol
	Up to 38400 baud rate
Ethernet (Optional)	10M/100M BaseT
	MODBUS TCP/IP Protocol
	Data Browsing through HTTP
	Sends e-mail automatically
PROFI-BUS (Optional)	PROFIBUS-DP/V0 Protocol
	Work as PROFIBUS slave, baud rate adaptive, up to 12M
	Model 1:Input Bytes 32,Output Bytes: 32 Model 2:Input Bytes 64,Output Bytes:2
	PROFIBUS standard according to EN 50170 vol.2
RS-485 (Optional):	2-wire connection
	MODBUS RTU Protocol
	Up to 38400 baud rate
BACnet MS/TP(Optional)	2-wire connection BACnet Protocol
BACnet IP(Optional)	RJ45 BACnet Protocol

Appendix B Ordering Information

Acuvim II series meter:

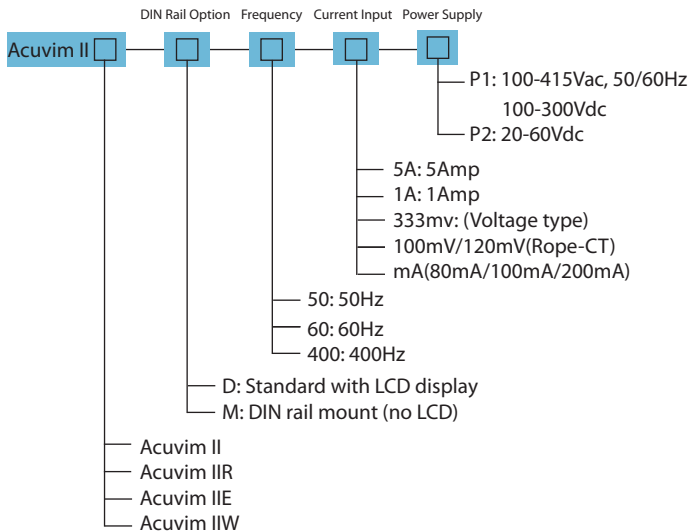

Acuvim II Base Meter Ordering Example: Acuvim IIR - D - 60 - 5A - P1

I/O Option module

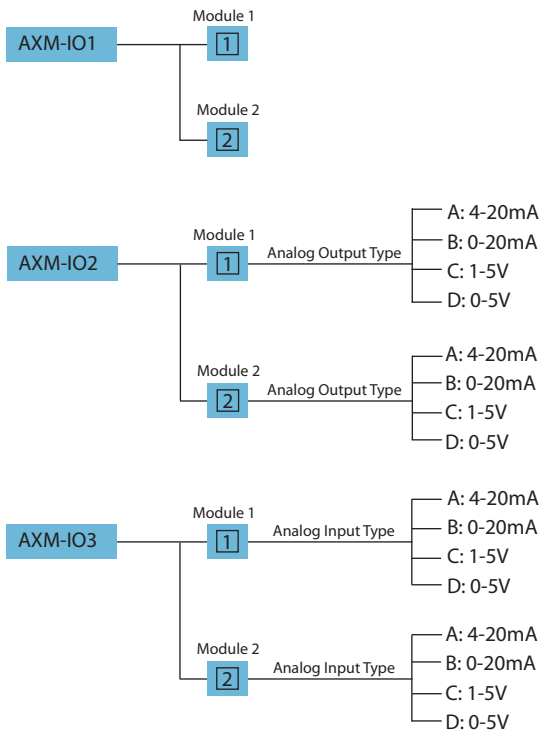

IO Module Ordering Example: AXM-IO2-1A

Remote Display Option

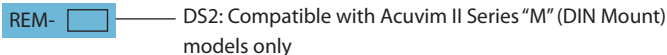

Communication Option Module

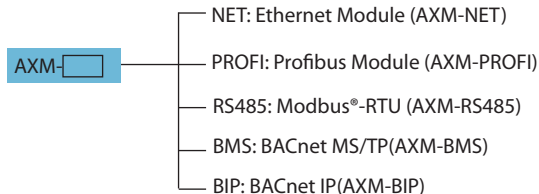

Note:

1. No more than 2 of the same I/O modules may be attached to the meter (example: 2 AXM-IO2). The same two I/O modules must be a different component number.
2. A maximum of 3 modules may be attached to the meter. If a communication module is used (example: AXM-NET), it must be installed on the back of the meter FIRST before the other modules are attached.
3. If you select Acuvim IIW products, and prepared to use DI recorder function, then select the IO module can only select logic number 1 module.
4. If you select Acuvim IIW products, you can only select 50Hz or 60Hz type.

Appendix C Revision History

Revision	Date	Description
1.0	20070915	First version
1.1	20070930	P47: change the flow chart; P86: change value of address 101dH from "Reserved" to "Basic parameter mode"; P93: change the description of "Basic analog measurement"; P101~P102: change the description "Counting number of I/O modules".
1.2	20071016	P50: change the flow chart; add the function: AO transforming parameters setting via the front panel.
1.21	20080303	Change the AO mode, see IO Module User's Manual; P64, P69, P89: Add 3 demand parameters for alarm.
1.22	20080625	Add transforming data type.
1.23	20080710	Change the ordering information.
1.30	20080912	Change the type of AO and AI to be read only.
1.40	20090305	Open the address of AO/AI type set; add current demand, maximum current demand and current demand alarm.
1.50	20090520	Add Acuvim IIR
1.51	20090626	Change the content
1.52	20090818	Change the content
1.53	20090909	P121: Add "Data logging operation examples"; Change the content of chapter 4 and 5.
1.60	20100930	Add Acuvim IIE functions; Add User's Manual of the accessory modules (IO Modules, Ethernet Module, Profibus Module)
1.61	20101122	Change the maximum Data-Logging sectors from 64 to 63. In the chapter of Tou (6.3.8), add the address of the max of demand and DST.
1.62	20110228	Change DI input voltage range, Change AD output address.

Revision	Date	Description
1.63	20120417	Change "Time of use (TOU)" Increase in "Acuvim IIW".
1.64	20120724	Update the method for generating CRC value; Change the voltage rated value and voltage swell threshold.
1.65	20120913	Change the Weekend Setting in TOU.
2.01	20130621	Add the parameter setting page and BACnet parameter setting page; Data logging Record mode description; Waveform recording function; Sealing function; AO function; Voltage wiring; Harmonic content rate range; Net electric range; Clear alarm directives; Update the webpage browsing and parameter settings, and add the SNMP and Sntp function.
2.02	20140214	Add DNP3.0 and BACnet Protocol Introduction.
2.03	20151111	Add the sub-phase energy of Trend recorded; Add the Current month energy and Prior month energy of TOU; Support mA transformer; Supports 400Hz signal input; Support 100ms Refresh Metering Parameter; Support mesh module; Support seven day energy billing

Make Energy Usage Smarter!



Accuenergy Corporation

Los Angeles-Toronto-Beijing

North America Toll Free: 1-877-721-8908

Web: www.accuenergy.com

Email: support@accuenergy.com